



Model	Color	Voltage	Power
OPT-RI4225-W	White	24V	1.2W
OPT-RI4225-B	Blue	24V	1.2W
OPT-RI4225-G	Green	24V	1.2W
OPT-RI4225-R	Red	24V	0.4W

JST SMR-02V-B, 2 Pin or Compactible Connector		Pin	Polarity	Wire Color
	2	1	+	Red
	1	2	-	Black



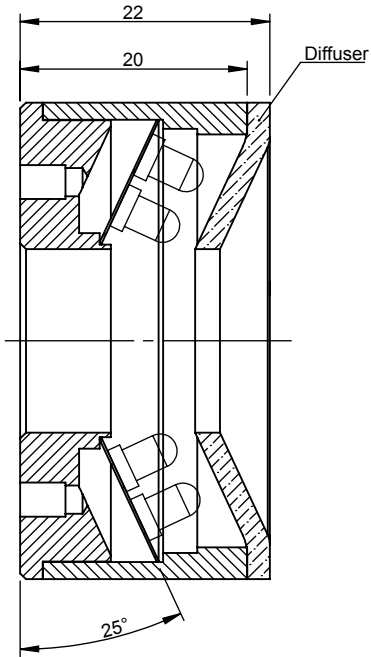
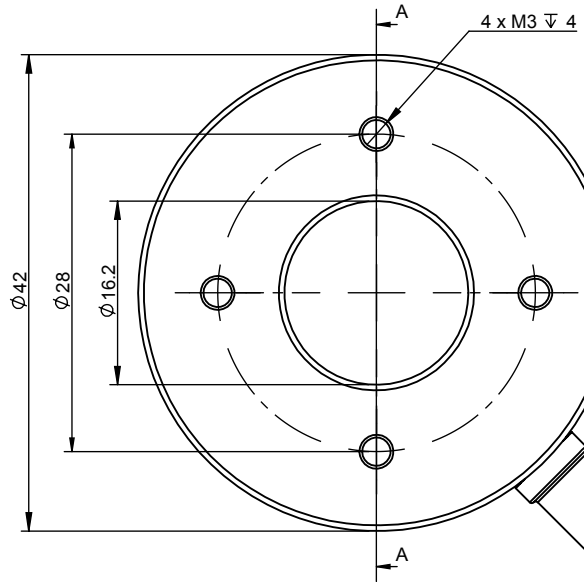

Sectional View A-A

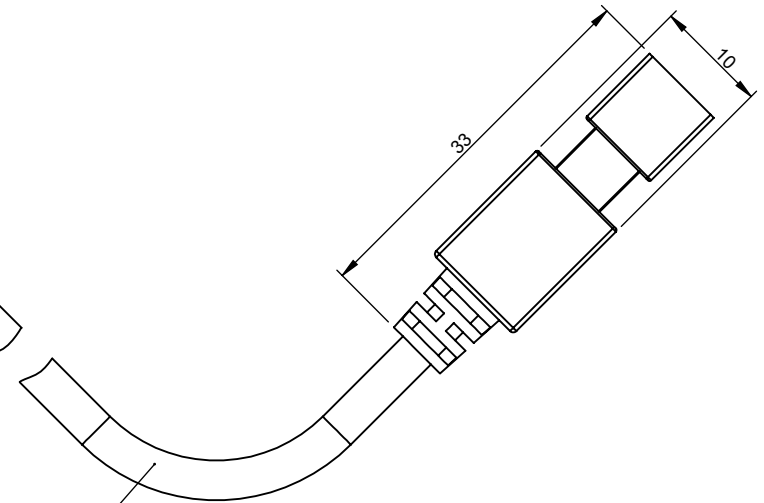

Minimum Bending Radius: 20mm
 Length: 800 ± 20mm
 Connector: JST SMR-02V-B



View Angle	Remark	Item	Signature	Date	 OPT <small>Machine Vision</small> OPT MACHINE VISION		
	1. Accessory: Diffuser ; 2. Advised Controller: OPT-AP1024F OPT-DPA2024E	Drawing					
Standard Difference		Design					
IT14		Check					
		Approve					
		Paper Size	A ₄				
Revised Date	2019-04-02	Scale	1.5:1	Page	1/1 Total Page	Version	V2.0

OPT-RI4225-X

Copyright © 2011 by OPT
 All Rights Reserved