

# Diffuse Ring Lights **OPT-RIE series**

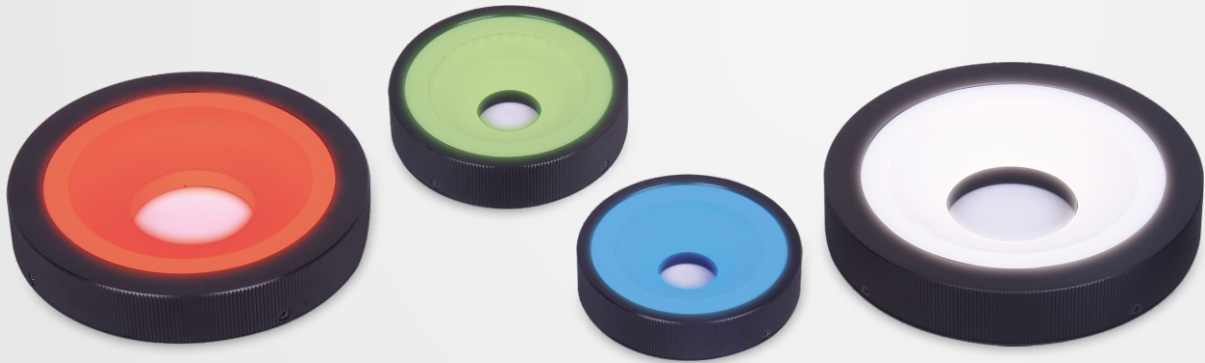

## Product Features

- Higher uniformity than OPT-RI series ring lights
- Providing uniform illumination for rough surfaces, eliminate flare, and highlight the 3D information
- Equipped with special diffuser to reduce reflection and allow uniform illumination

## Application Cases

- Positioning and gauging for metal parts
- Surface defects detection

## Selection Guide

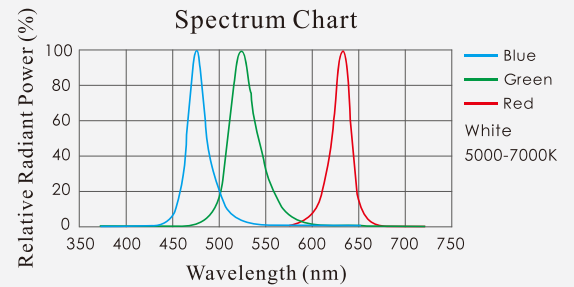
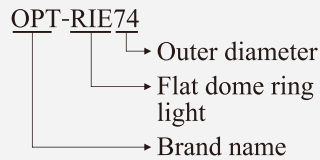

Note: The data is for reference only.

## Section Structure Drawing

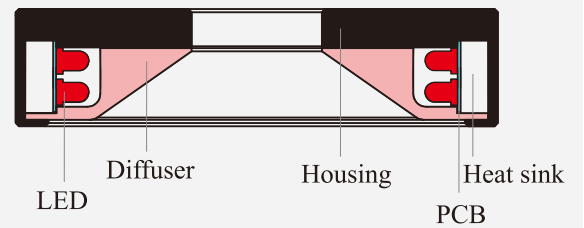

## Customizable Items

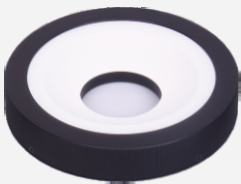

Color



Mounting



Size

## Uniformity Chart

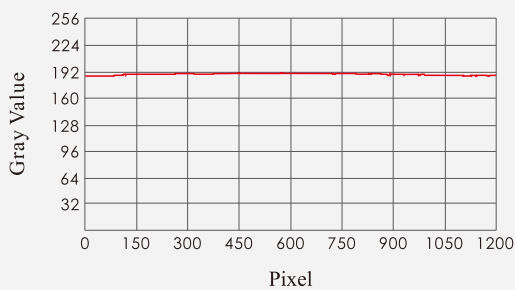

Note: The data is for reference only.

## Application Example

- OCR for metal parts



Workpiece



Illumination



SciSmart Analysis Result



Image

**Application Examples**

■ Gauging for metal parts

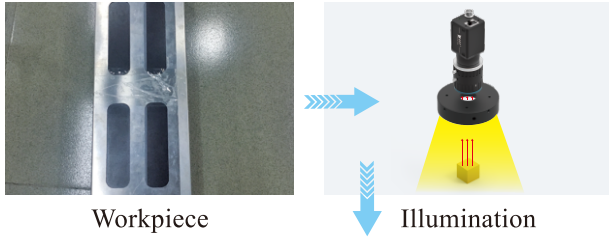

Workpiece

Illumination

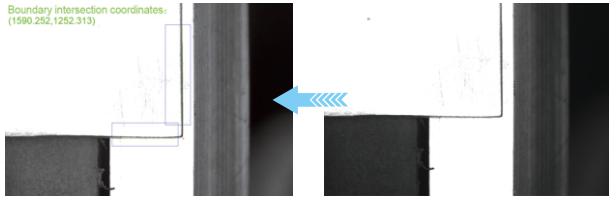

SciSmart Analysis Result

Image

■ Circuit inspection

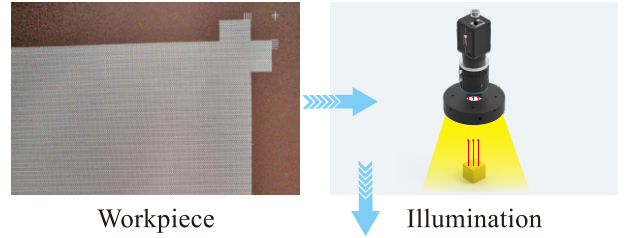

Workpiece

Illumination

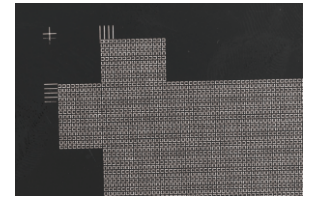

Image

**Model Table**

No.	Model	* Output ●	* Output ○●●	Recommended controller
1	OPT-RIE50	24V/0.9W	24V/0.9W	OPT-DPA1024E OPT-DPA2024E
2	OPT-RIE74	24V/1.8W	24V/3.4W	
3	OPT-RIE100	24V/3.5W	24V/4.9W	
4	OPT-RIE150	24V/5W	24V/8.8W	

\* Note: The data is for reference only.

**Dimensions (mm)**

1.OPT-RIE50

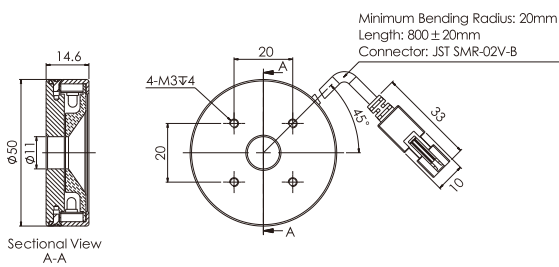

2.OPT-RIE74

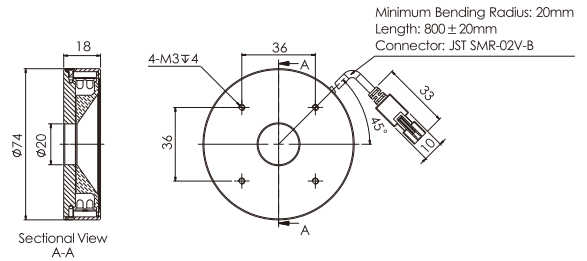

3.OPT-RIE100

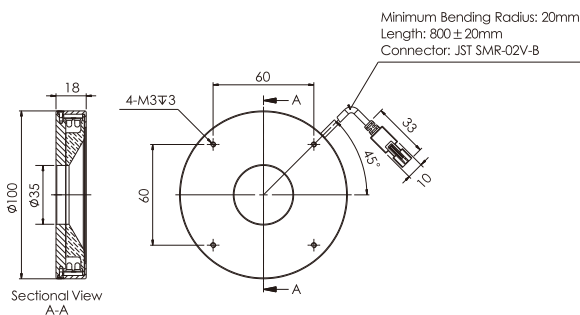

4.OPT-RIE150

