

## TECHNICAL REFERENCE

---

FLIR **ORYX**<sup>®</sup>

*ORX-10G-32S4 / ORX-10GS-32S4*

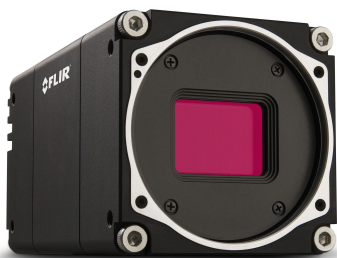

**Revised 2/21/2020**

Oryx part numbers with 10G and 10GS are functionally the same and differ only in dimensions and mass.

## FCC Compliance

This device complies with Part 15 of the FCC rules. Operation is subject to the following two conditions: (1) This device may not cause harmful interference, and (2) this device must accept any interference received, including interference that may cause undesirable operation.

## Korean EMC Certification

The KCC symbol indicates that this product complies with Korea's Electrical Communication Basic Law regarding EMC testing for electromagnetic interference (EMI) and susceptibility (EMS). This equipment has received a conformity assessment for use in a business environment, and it may cause radio frequency interference if it is used in a home environment.

## Hardware Warranty

The warranty for the Oryx camera is 3 years. For detailed information on how to repair or replace your camera, please see the [terms and conditions on our website](#).

## Export Control

The ECCN for this product is EAR099.

## WEEE

The symbol indicates that this product may not be treated as household waste. Please ensure this product is properly disposed as inappropriate waste handling of this product may cause potential hazards to the environment and human health. For more detailed information about recycling of this product, please contact us.



## Trademarks

Names and marks appearing on the products herein are either registered trademarks or trademarks of FLIR Systems, Inc. and/or its subsidiaries.

## Licensing

To view the licenses of open source packages used in this product please see [What open source packages does firmware use?](#)



# Table of Contents

|  |           |
|--|-----------|
| <b>1 Oryx Technical Reference</b>              | <b>1</b>  |
| <b>2 Specifications and Frame Rates</b>        | <b>2</b>  |
| 2.1 General Specifications                     | 2         |
| 2.2 Oryx ORX-10G-32S4M Supported Pixel Formats | 3         |
| 2.3 Oryx ORX-10G-32S4M Frame Rate Table        | 3         |
| 2.4 Oryx ORX-10G-32S4C Supported Pixel Formats | 7         |
| 2.5 Oryx ORX-10G-32S4C Frame Rate Table        | 7         |
| <b>3 Acquisition Control</b>                   | <b>13</b> |
| 3.1 Acquisition and Frame Rate                 | 13        |
| 3.2 Exposure Time Modes                        | 13        |
| 3.2.1 Trigger Features                         | 13        |
| 3.3 Summary Table                              | 14        |
| 3.4 Acquisition Control Features               | 16        |
| 3.4.1 Acquisition Mode                         | 16        |
| 3.4.2 Acquisition Start                        | 17        |
| 3.4.3 Acquisition Stop                         | 17        |
| 3.4.4 Acquisition Frame Count                  | 17        |
| 3.4.5 Acquisition Burst Frame Count            | 18        |
| 3.4.6 Exposure Mode                            | 18        |
| 3.4.7 Exposure Time                            | 18        |
| 3.4.8 Exposure Auto                            | 19        |
| 3.4.9 Acquisition Frame Rate                   | 19        |
| 3.4.10 Resulting Frame Rate                    | 20        |
| 3.4.11 Acquisition Frame Rate Enable           | 20        |
| 3.4.12 Acquisition Line Rate                   | 20        |
| 3.4.13 Trigger Selector                        | 20        |
| 3.4.14 Trigger Mode                            | 21        |
| 3.4.15 Trigger Software                        | 21        |
| 3.4.16 Trigger Source                          | 22        |
| 3.4.17 Trigger Activation                      | 23        |

|   |           |
|---|-----------|
| 3.4.18 Trigger Overlap .....                        | 23        |
| 3.4.19 Trigger Delay .....                          | 24        |
| 3.4.20 Sensor Shutter Mode .....                    | 24        |
| <b>4 Analog Control .....</b>                       | <b>25</b> |
| 4.1 Gain .....                                      | 25        |
| 4.2 Black Level .....                               | 25        |
| 4.3 White Balance - Color Models .....              | 25        |
| 4.4 Gamma .....                                     | 26        |
| 4.5 Sharpening - Color Models .....                 | 26        |
| 4.6 Summary Table .....                             | 27        |
| 4.7 Analog Control Features .....                   | 28        |
| 4.7.1 Gain Selector .....                           | 28        |
| 4.7.2 Gain .....                                    | 28        |
| 4.7.3 Gain Auto .....                               | 29        |
| 4.7.4 Black Level Selector .....                    | 29        |
| 4.7.5 Black Level Raw .....                         | 30        |
| 4.7.6 Black Level .....                             | 30        |
| 4.7.7 Black Level Clamping Enable .....             | 30        |
| 4.7.8 Balance Ratio Selector .....                  | 31        |
| 4.7.9 Balance Ratio .....                           | 31        |
| 4.7.10 Balance White Auto .....                     | 31        |
| 4.7.11 Gamma .....                                  | 32        |
| 4.7.12 Gamma Enable .....                           | 32        |
| 4.7.13 Sharpening Enable .....                      | 33        |
| 4.7.14 Sharpening Auto .....                        | 33        |
| 4.7.15 Sharpening .....                             | 33        |
| 4.7.16 Sharpening Threshold .....                   | 34        |
| <b>5 Image Format Control .....</b>                 | <b>35</b> |
| 5.1 Region Of Interest .....                        | 35        |
| 5.2 Binning/Decimation .....                        | 35        |
| 5.2.1 Binning/Decimation Feature Dependency .....   | 36        |
| 5.3 Pixel Format .....                              | 36        |
| 5.3.1 Single Channel 8-bit and 16-bit Formats ..... | 36        |

|  |    |
|--|----|
| 5.3.2 Single Channel 10-bit Formats .....        | 37 |
| 5.3.3 Single Channel 12-bit Formats .....        | 38 |
| 5.3.4 Multi-Channel Formats - Color Models ..... | 38 |
| 5.3.4.1 YCbCr8 / YUV444Packed .....              | 39 |
| 5.3.4.2 YCbCr422_8 / YUV422Packed .....          | 39 |
| 5.3.4.3 YCbCr411_8 / YUV411Packed .....          | 40 |
| 5.4 ADC Bit Depth .....                          | 41 |
| 5.5 Test Pattern .....                           | 41 |
| 5.6 Reverse X .....                              | 42 |
| 5.7 Reverse Y .....                              | 42 |
| 5.8 Summary Table .....                          | 42 |
| 5.9 Image Format Control Features .....          | 44 |
| 5.9.1 Sensor Width .....                         | 45 |
| 5.9.2 Sensor Height .....                        | 45 |
| 5.9.3 Width Max .....                            | 45 |
| 5.9.4 Height Max .....                           | 46 |
| 5.9.5 Width .....                                | 46 |
| 5.9.6 Height .....                               | 46 |
| 5.9.7 Offset X .....                             | 47 |
| 5.9.8 Offset Y .....                             | 47 |
| 5.9.9 Pixel Format .....                         | 47 |
| 5.9.10 Pixel Size .....                          | 49 |
| 5.9.11 Pixel Color Filter .....                  | 50 |
| 5.9.12 Pixel Dynamic Range Min .....             | 51 |
| 5.9.13 Pixel Dynamic Range Max .....             | 51 |
| 5.9.14 ISP Enable .....                          | 52 |
| 5.9.15 Binning Selector .....                    | 52 |
| 5.9.16 Binning Horizontal Mode .....             | 52 |
| 5.9.17 Binning Vertical Mode .....               | 53 |
| 5.9.18 Binning Horizontal .....                  | 53 |
| 5.9.19 Binning Vertical .....                    | 53 |
| 5.9.20 Decimation Selector .....                 | 54 |
| 5.9.21 Decimation Horizontal Mode .....          | 54 |



|   |           |
|---|-----------|
| 5.9.22 Decimation Vertical Mode .....           | 55        |
| 5.9.23 Decimation Horizontal .....              | 55        |
| 5.9.24 Decimation Vertical .....                | 55        |
| 5.9.25 Reverse X .....                          | 56        |
| 5.9.26 Reverse Y .....                          | 56        |
| 5.9.27 Test Pattern Generator Selector .....    | 56        |
| 5.9.28 Test Pattern .....                       | 57        |
| 5.9.29 ADC Bit Depth .....                      | 57        |
| <b>6 Device Control .....</b>                   | <b>59</b> |
| 6.1 General Information .....                   | 59        |
| 6.2 Bandwidth .....                             | 59        |
| 6.3 Timestamp .....                             | 59        |
| 6.4 Power Supply .....                          | 59        |
| 6.5 Device Reset .....                          | 59        |
| 6.6 Summary Table .....                         | 59        |
| 6.7 Device Control Features .....               | 62        |
| 6.7.1 Device Scan Type .....                    | 62        |
| 6.7.2 Device Vendor Name .....                  | 62        |
| 6.7.3 Device Model Name .....                   | 62        |
| 6.7.4 Sensor Description .....                  | 63        |
| 6.7.5 Device Manufacturer Info .....            | 63        |
| 6.7.6 Firmware Version .....                    | 63        |
| 6.7.7 Serial Number .....                       | 64        |
| 6.7.8 User ID .....                             | 64        |
| 6.7.9 Device TL Type .....                      | 64        |
| 6.7.10 TL Version Major .....                   | 65        |
| 6.7.11 TL Version Minor .....                   | 65        |
| 6.7.12 Device Max Throughput .....              | 65        |
| 6.7.13 Link Speed .....                         | 66        |
| 6.7.14 Device Link Throughput Limit .....       | 66        |
| 6.7.15 Device Link Bandwidth Reserve .....      | 66        |
| 6.7.16 Device Link Current Throughput .....     | 67        |
| 6.7.17 Control Packets Reserved Bandwidth ..... | 67        |

|  |           |
|--|-----------|
| 6.7.18 Stream Channel Count .....                | 67        |
| 6.7.19 Event Channel Count .....                 | 68        |
| 6.7.20 Character Set .....                       | 68        |
| 6.7.21 Device Reset .....                        | 69        |
| 6.7.22 Device Indicator Mode .....               | 69        |
| 6.7.23 Registers Endianness .....                | 69        |
| 6.7.24 Device Temperature Selector .....         | 70        |
| 6.7.25 Device Temperature .....                  | 70        |
| 6.7.26 Timestamp Reset .....                     | 70        |
| 6.7.27 Timestamp Latch .....                     | 71        |
| 6.7.28 Timestamp Latch Value .....               | 71        |
| 6.7.29 Device Power Supply Selector .....        | 71        |
| 6.7.30 Power Supply Voltage .....                | 72        |
| 6.7.31 Power Supply Current .....                | 72        |
| 6.7.32 Device Uptime .....                       | 72        |
| 6.7.33 Link Uptime .....                         | 73        |
| 6.7.34 Enumeration Count .....                   | 73        |
| 6.7.35 Factory Reset .....                       | 73        |
| 6.7.36 Max Device Reset Time .....               | 74        |
| <b>7 Transport Layer Control .....</b>           | <b>75</b> |
| 7.1 Summary Table .....                          | 75        |
| 7.2 Transport Layer Control Features .....       | 75        |
| 7.2.1 Payload Size .....                         | 75        |
| 7.2.2 GigE Vision .....                          | 76        |
| 7.2.3 Link Error Count .....                     | 76        |
| 7.2.4 Packet Resend Request Count .....          | 76        |
| 7.2.5 Packet Resend Requests Dropped Count ..... | 77        |
| 7.3 GigE Vision .....                            | 77        |
| 7.3.1 Summary Table .....                        | 77        |
| 7.3.2 GigE Vision Features .....                 | 81        |
| 7.3.2.1 Supported Option Selector .....          | 81        |
| 7.3.2.2 Supported Option .....                   | 82        |
| 7.3.2.3 Interface Selector .....                 | 82        |

|  |    |
|--|----|
| 7.3.2.4 MAC Address .....                            | 83 |
| 7.3.2.5 Current IP Configuration LLA .....           | 83 |
| 7.3.2.6 Current IP Configuration DHCP .....          | 83 |
| 7.3.2.7 Current IP Configuration Persistent IP ..... | 83 |
| 7.3.2.8 Current IP Address .....                     | 84 |
| 7.3.2.9 Current Subnet Mask .....                    | 84 |
| 7.3.2.10 Current Default Gateway .....               | 84 |
| 7.3.2.11 First URL .....                             | 85 |
| 7.3.2.12 Second URL .....                            | 85 |
| 7.3.2.13 Number Of Interfaces .....                  | 85 |
| 7.3.2.14 Persistent IP Address .....                 | 86 |
| 7.3.2.15 Persistent Subnet Mask .....                | 86 |
| 7.3.2.16 Persistent Default Gateway .....            | 86 |
| 7.3.2.17 Heartbeat Timeout .....                     | 86 |
| 7.3.2.18 Timestamp Tick Frequency .....              | 87 |
| 7.3.2.19 Pending Acknowledge Enable .....            | 87 |
| 7.3.2.20 Heartbeat Disable .....                     | 87 |
| 7.3.2.21 Pending Timeout .....                       | 88 |
| 7.3.2.22 IEEE 1588 .....                             | 88 |
| 7.3.2.23 IEEE 1588 Status .....                      | 88 |
| 7.3.2.24 CCP .....                                   | 89 |
| 7.3.2.25 MCP Host Port .....                         | 89 |
| 7.3.2.26 Message Channel Destination Address .....   | 90 |
| 7.3.2.27 Message Channel Transmission Timeout .....  | 90 |
| 7.3.2.28 Message Channel Retry Count .....           | 90 |
| 7.3.2.29 Message Channel Source Port .....           | 91 |
| 7.3.2.30 Stream Channel Selector .....               | 91 |
| 7.3.2.31 SCCFG Unconditional Streaming .....         | 91 |
| 7.3.2.32 Gev SCCFG Extended Chunk Data .....         | 92 |
| 7.3.2.33 SCP Direction .....                         | 92 |
| 7.3.2.34 SCP Interface Index .....                   | 92 |
| 7.3.2.35 SCP Host Port .....                         | 93 |
| 7.3.2.36 SCPS Fire Test Packet .....                 | 93 |



|   |            |
|---|------------|
| 7.3.2.37 SCPS Do Not Fragment .....   | 93         |
| 7.3.2.38 SCPS Big Endian .....  | 94         |
| 7.3.2.39 SCPS Packet Size .....   | 94         |
| 7.3.2.40 Stream Channel Packet Delay .....  | 94         |
| 7.3.2.41 Stream Channel Destination Address .....                                   | 95         |
| 7.3.2.42 Stream Channel Source Port .....   | 95         |
| 7.3.2.43 IEEE 1588 Mode .....   | 95         |
| <b>8 Sequencer Control .....</b>  | <b>97</b>  |
| 8.1 Sequenced Feature Settings .....  | 97         |
| 8.1.1 Sequencer Configuration .....   | 98         |
| 8.1.2 Sequencer Execution .....   | 99         |
| 8.1.3 Sequencer Usage Example - Simple features change while acquiring images ..... | 100        |
| 8.2 Summary Table .....   | 101        |
| 8.3 Sequencer Control Features .....  | 102        |
| 8.3.1 Sequencer Mode .....  | 102        |
| 8.3.2 Sequencer Configuration Mode .....  | 103        |
| 8.3.3 Sequencer Configuration Valid .....   | 103        |
| 8.3.4 Sequencer Feature Selector .....  | 104        |
| 8.3.5 Sequencer Feature Enable .....  | 104        |
| 8.3.6 Sequencer Set Start .....   | 104        |
| 8.3.7 Sequencer Set Active .....  | 105        |
| 8.3.8 Sequencer Set Selector .....  | 105        |
| 8.3.9 Sequencer Set Valid .....   | 105        |
| 8.3.10 Sequencer Set Save .....   | 106        |
| 8.3.11 Sequencer Set Load .....   | 106        |
| 8.3.12 Sequencer Path Selector .....  | 106        |
| 8.3.13 Sequencer Trigger Source .....   | 107        |
| 8.3.14 Sequencer Trigger Activation .....   | 107        |
| 8.3.15 Sequencer Set Next .....   | 107        |
| <b>9 Color Transformation Control .....</b>   | <b>109</b> |
| 9.1 Summary Table .....   | 109        |
| 9.2 Color Transformation Control Features .....                                     | 110        |
| 9.2.1 Color Transformation Selector .....   | 110        |

|  |            |
|--|------------|
| 9.2.2 Color Transformation Enable .....          | 111        |
| 9.2.3 Color Transformation Value Selector .....  | 111        |
| 9.2.4 Color Transformation Value .....           | 112        |
| 9.2.5 RGB Transform Light Source .....           | 112        |
| 9.2.6 Saturation Enable .....                    | 113        |
| 9.2.7 Saturation .....                           | 113        |
| <b>10 Auto Algorithm Control .....</b>           | <b>114</b> |
| 10.1 Auto Exposure (AE) .....                    | 114        |
| 10.1.1 Auto Exposure Features .....              | 114        |
| 10.1.1.1 Backlight Compensation .....            | 115        |
| 10.1.1.2 Excessive Frontlight Compensation ..... | 115        |
| 10.1.1.3 Normal Lighting .....                   | 115        |
| 10.1.1.4 Average Metering .....                  | 115        |
| 10.1.1.5 Spot Metering .....                     | 115        |
| 10.1.1.6 Partial Metering .....                  | 115        |
| 10.2 Auto White Balance - Color Models .....     | 116        |
| 10.3 Summary Table .....                         | 116        |
| 10.4 Auto Algorithm Control Features .....       | 119        |
| 10.4.1 ROI Selector .....                        | 119        |
| 10.4.2 ROI Enable .....                          | 119        |
| 10.4.3 ROI Offset X .....                        | 120        |
| 10.4.4 ROI Offset Y .....                        | 120        |
| 10.4.5 ROI Width .....                           | 120        |
| 10.4.6 ROI Height .....                          | 121        |
| 10.4.7 White Balance Auto Profile .....          | 121        |
| 10.4.8 White Balance Auto Lower Limit .....      | 121        |
| 10.4.9 White Balance Auto Upper Limit .....      | 122        |
| 10.4.10 White Balance Auto Damping .....         | 122        |
| 10.4.11 Target Grey Value Auto .....             | 122        |
| 10.4.12 Target Grey Value .....                  | 123        |
| 10.4.13 Lighting Mode .....                      | 123        |
| 10.4.14 Metering Mode .....                      | 124        |
| 10.4.15 Exposure Time Lower Limit .....          | 124        |

|  |            |
|--|------------|
| 10.4.16 Exposure Time Upper Limit .....                              | 125        |
| 10.4.17 Gain Lower Limit .....                                       | 125        |
| 10.4.18 Gain Upper Limit .....                                       | 125        |
| 10.4.19 Target Grey Value Lower Limit .....                          | 126        |
| 10.4.20 Target Grey Value Upper Limit .....                          | 126        |
| 10.4.21 EV Compensation .....  | 126        |
| 10.4.22 Auto Exposure Damping .....                                  | 127        |
| 10.4.23 Auto Exposure Control Priority .....                         | 127        |
| <b>11 Defective Pixel Correction .....</b>                           | <b>129</b> |
| 11.1 Modifying the List of Defective Pixels .....                    | 129        |
| 11.1.1 Example: Adding a location to the Defective Pixel Table ..... | 129        |
| 11.2 Summary Table .....   | 130        |
| 11.3 Defective Pixel Correction Features .....                       | 131        |
| 11.3.1 Defect Correct Static Enable .....                            | 131        |
| 11.3.2 Defect Correction Mode .....                                  | 131        |
| 11.3.3 Defect Table Pixel Count .....                                | 131        |
| 11.3.4 Defect Table Index .....                                      | 132        |
| 11.3.5 Defect X Coordinate .....                                     | 132        |
| 11.3.6 Defect Y Coordinate .....                                     | 132        |
| 11.3.7 Defect Table Apply .....                                      | 133        |
| 11.3.8 Defect Table Save .....                                       | 133        |
| 11.3.9 Defect Table Factory Restore .....                            | 133        |
| <b>12 User Set Control .....</b>                                     | <b>135</b> |
| 12.1 Types of User Sets .....  | 135        |
| 12.2 Start-up User Set .....   | 135        |
| 12.3 User Set Managed Features .....                                 | 135        |
| 12.4 User Set Conversion .....                                       | 135        |
| 12.5 Summary Table .....   | 136        |
| 12.6 User Set Control Features .....                                 | 136        |
| 12.6.1 User Set Selector .....                                       | 136        |
| 12.6.2 User Set Load .....   | 137        |
| 12.6.3 User Set Save .....   | 137        |
| 12.6.4 User Set Default .....  | 137        |

|   |            |
|---|------------|
| 12.6.5 User Set Feature Selector .....      | 138        |
| 12.6.6 User Set Feature Enable .....        | 145        |
| <b>13 Chunk Data Control .....</b>          | <b>146</b> |
| 13.1 Summary Table .....                    | 146        |
| 13.2 Chunk Data Control Features .....      | 147        |
| 13.2.1 Chunk Mode Active .....              | 147        |
| 13.2.2 Chunk Selector .....                 | 148        |
| 13.2.3 Chunk Enable .....                   | 149        |
| 13.2.4 Chunk Image .....                    | 149        |
| 13.2.5 Image CRC .....                      | 149        |
| 13.2.6 Chunk Frame ID .....                 | 150        |
| 13.2.7 Chunk Offset X .....                 | 150        |
| 13.2.8 Chunk Offset Y .....                 | 150        |
| 13.2.9 Chunk Width .....                    | 151        |
| 13.2.10 Chunk Height .....                  | 151        |
| 13.2.11 Chunk Pixel Format .....            | 151        |
| 13.2.12 Chunk Exposure Time .....           | 152        |
| 13.2.13 Chunk Gain Selector .....           | 152        |
| 13.2.14 Chunk Gain .....                    | 153        |
| 13.2.15 Chunk Black Level Selector .....    | 153        |
| 13.2.16 Chunk Black Level .....             | 154        |
| 13.2.17 Chunk Timestamp .....               | 154        |
| 13.2.18 Chunk Sequencer Set Active .....    | 154        |
| 13.2.19 Chunk Serial Data Length .....      | 155        |
| 13.2.20 Chunk Serial Data .....             | 155        |
| 13.2.21 Chunk Serial Receive Overflow ..... | 155        |
| <b>14 LUT Control .....</b>                 | <b>156</b> |
| 14.1 Summary Table .....                    | 156        |
| 14.2 LUT Control Features .....             | 157        |
| 14.2.1 LUT Selector .....                   | 157        |
| 14.2.2 LUT Enable .....                     | 157        |
| 14.2.3 LUT Index .....                      | 158        |
| 14.2.4 LUT Value .....                      | 158        |



|  |            |
|--|------------|
| 14.2.5 LUT Value All .....                           | 158        |
| <b>15 Event Control .....</b>                        | <b>159</b> |
| 15.0.1 Event Features .....                          | 159        |
| 15.1 Summary Table .....                             | 159        |
| 15.2 Event Control Features .....                    | 159        |
| 15.2.1 Event Selector .....                          | 160        |
| 15.2.2 Event Notification .....                      | 160        |
| 15.2.3 Event Exposure End Data .....                 | 160        |
| 15.2.4 Event Error Data .....                        | 161        |
| 15.2.5 Event Serial Port Receive Data .....          | 161        |
| 15.2.6 Event Test Data .....                         | 161        |
| 15.3 Event Exposure End Data .....                   | 162        |
| 15.3.1 Summary Table .....                           | 162        |
| 15.3.2 Event Exposure End Data Features .....        | 162        |
| 15.3.2.1 Event Exposure End .....                    | 162        |
| 15.3.2.2 Event Exposure End Timestamp .....          | 162        |
| 15.3.2.3 Event Exposure End Frame ID .....           | 163        |
| 15.4 Event Error Data .....                          | 163        |
| 15.4.1 Summary Table .....                           | 163        |
| 15.4.2 Event Error Data Features .....               | 163        |
| 15.4.2.1 Event Error .....                           | 164        |
| 15.4.2.2 Event Error Timestamp .....                 | 164        |
| 15.4.2.3 Event Error Frame ID .....                  | 164        |
| 15.4.2.4 Event Error Code .....                      | 164        |
| 15.5 Event Serial Port Receive Data .....            | 165        |
| 15.5.1 Summary Table .....                           | 165        |
| 15.5.2 Event Serial Port Receive Data Features ..... | 165        |
| 15.5.2.1 Event Serial Port Receive .....             | 165        |
| 15.5.2.2 Event Serial Port Receive Timestamp .....   | 166        |
| 15.5.2.3 Event Serial Data .....                     | 166        |
| 15.5.2.4 Event Serial Data Length .....              | 166        |
| 15.5.2.5 Event Serial Receive Overflow .....         | 167        |
| 15.6 Event Test Data .....                           | 167        |

|   |            |
|---|------------|
| 15.6.1 Summary Table .....                    | 167        |
| 15.6.2 Event Test Data Features .....         | 167        |
| 15.6.2.1 Event Test .....                     | 167        |
| 15.6.2.2 Event Test Timestamp .....           | 168        |
| <b>16 Counter And Timer Control .....</b>     | <b>169</b> |
| 16.1 Summary Table .....                      | 170        |
| 16.2 Counter And Timer Control Features ..... | 171        |
| 16.2.1 Counter Selector .....                 | 171        |
| 16.2.2 Counter Event Source .....             | 171        |
| 16.2.3 Counter Event Activation .....         | 173        |
| 16.2.4 Counter Duration .....                 | 173        |
| 16.2.5 Counter Value .....                    | 174        |
| 16.2.6 Counter Value At Reset .....           | 174        |
| 16.2.7 Counter Trigger Source .....           | 174        |
| 16.2.8 Counter Trigger Activation .....       | 175        |
| 16.2.9 Counter Reset Source .....             | 176        |
| 16.2.10 Counter Reset Activation .....        | 177        |
| 16.2.11 Counter Status .....                  | 178        |
| 16.2.12 Counter Delay .....                   | 178        |
| <b>17 Test Control .....</b>                  | <b>180</b> |
| 17.1 Summary Table .....                      | 180        |
| 17.2 Test Control Features .....              | 180        |
| 17.2.1 Test Event Generate .....              | 180        |
| 17.2.2 Test 0001 .....                        | 180        |
| <b>18 Logic Block Control .....</b>           | <b>182</b> |
| 18.1 Summary Table .....                      | 183        |
| 18.2 Logic Block Control Features .....       | 183        |
| 18.2.1 Logic Block Selector .....             | 183        |
| 18.2.2 Logic Block LUT Selector .....         | 184        |
| 18.2.3 Logic Block LUT Input Selector .....   | 184        |
| 18.2.4 Logic Block LUT Input Source .....     | 185        |
| 18.2.5 Logic Block LUT Input Activation ..... | 186        |
| 18.2.6 Logic Block LUT Output Value All ..... | 187        |



|   |            |
|---|------------|
| 18.2.7 Logic Block LUT Row Index .....              | 187        |
| 18.2.8 Logic Block LUT Output Value .....           | 187        |
| <b>19 Digital IO Control .....</b>                  | <b>188</b> |
| 19.1 Summary Table .....                            | 190        |
| 19.2 Digital IO Control Features .....              | 191        |
| 19.2.1 Line Selector .....                          | 191        |
| 19.2.2 Line Mode .....                              | 192        |
| 19.2.3 3.3V Enable .....                            | 192        |
| 19.2.4 Line Inverter .....                          | 193        |
| 19.2.5 Line Status .....                            | 193        |
| 19.2.6 Line Status All .....                        | 193        |
| 19.2.7 Input filter Selector .....                  | 194        |
| 19.2.8 Line Filter Width .....                      | 194        |
| 19.2.9 Line Source .....                            | 194        |
| 19.2.10 Line Format .....                           | 195        |
| 19.2.11 Exposure Active Mode .....                  | 196        |
| 19.2.12 User Output Selector .....                  | 196        |
| 19.2.13 User Output Value .....                     | 197        |
| 19.2.14 User Output Value All .....                 | 197        |
| <b>20 Serial Port Control .....</b>                 | <b>199</b> |
| 20.1 Serial Port .....                              | 199        |
| 20.2 Summary Table .....                            | 199        |
| 20.3 Serial Port Control Features .....             | 200        |
| 20.3.1 Serial Port Selector .....                   | 200        |
| 20.3.2 Serial Port Source .....                     | 201        |
| 20.3.3 Serial Port Baud Rate .....                  | 201        |
| 20.3.4 Serial Port Data Bits .....                  | 202        |
| 20.3.5 Serial Port Stop Bits .....                  | 202        |
| 20.3.6 Serial Port Parity .....                     | 203        |
| 20.3.7 Transmit Queue Max Character Count .....     | 203        |
| 20.3.8 Transmit Queue Current Character Count ..... | 204        |
| 20.3.9 Receive Queue Max Character Count .....      | 204        |
| 20.3.10 Receive Queue Current Character Count ..... | 204        |

|   |            |
|---|------------|
| 20.3.11 Receive Queue Clear .....               | 205        |
| 20.3.12 Receive Framing Error Count .....       | 205        |
| 20.3.13 Receive Parity Error Count .....        | 205        |
| <b>20 File Access .....</b>                     | <b>207</b> |
| 20.1 File Access .....                          | 207        |
| 20.2 Summary Table .....                        | 207        |
| 20.3 File Access Features .....                 | 208        |
| 20.3.1 File Selector .....                      | 208        |
| 20.3.2 File Operation Selector .....            | 208        |
| 20.3.3 File Operation Execute .....             | 209        |
| 20.3.4 File Open Mode .....                     | 209        |
| 20.3.5 File Access Buffer .....                 | 210        |
| 20.3.6 File Access Offset .....                 | 210        |
| 20.3.7 File Access Length .....                 | 210        |
| 20.3.8 File Operation Status .....              | 211        |
| 20.3.9 File Operation Result .....              | 211        |
| 20.3.10 File Size .....                         | 212        |
| <b>21 Transfer Control .....</b>                | <b>213</b> |
| 21.1 Summary Table .....                        | 214        |
| 21.2 Transfer Control Features .....            | 214        |
| 21.2.1 Transfer Control Mode .....              | 215        |
| 21.2.2 Transfer Operation Mode .....            | 215        |
| 21.2.3 Transfer Block Count .....               | 215        |
| 21.2.4 Transfer Queue Max Block Count .....     | 216        |
| 21.2.5 Transfer Queue Current Block Count ..... | 216        |
| 21.2.6 Transfer Queue Overflow Count .....      | 216        |
| 21.2.7 Transfer Queue Mode .....                | 217        |
| 21.2.8 Transfer Start .....                     | 217        |
| 21.2.9 Transfer Stop .....                      | 218        |
| <b>Contacting Us .....</b>                      | <b>219</b> |



# 1 Oryx Technical Reference

Welcome to the Oryx camera. We offer a number of resources to assist you with the Oryx.

- **Spinnaker SDK**—software development kit that provides GenICam-compliant controls to create applications for the camera. Spinnaker is available for download. Each installation includes API documentation for C, C++, and C#.
- **Release Notes**—information about the current firmware release including feature additions or changes, bug fixes, and known issues.
- **Specifications**—information about the camera model as it performs with the current firmware.
- **Getting Started**—quick start guide for installing the camera and software.
- **Installation Guide**—information about installing the camera and SDK, the physical interface and mechanical properties, troubleshooting and how to get help. This document is available as a PDF for download or as a webpage included in the firmware release package.
- **Technical Reference**—information about the features supported by the camera model with the current firmware, including: image format control, acquisition control, sequencing, binning/decimation, and others. This document is available as a PDF for download or as a webpage included in the firmware release package.
- **Firmware**—programming inserted into the programmable ROM of the camera that can be updated in-field. New firmware packages are available for download and include both the firmware file and documentation.

These resources as well as knowledge base articles and application notes can be found on the Support page for the product.

[Oryx Support Articles](#)

[Oryx Resources](#)

---

## 2 Specifications and Frame Rates

Oryx part numbers with 10G and 10GS are functionally the same and differ only in dimensions and mass.

### 2.1 General Specifications

|                            | Oryx ORX-10G-32S4M  | Oryx ORX-10G-32S4C  |
|----------------------------|---|---|
| <b>Firmware Version</b>    | 1907.1.10.0   | 1907.1.10.0   |
| <b>Model Name</b>          | Oryx ORX-10G-32S4M  | Oryx ORX-10G-32S4C  |
| <b>Resolution</b>          | 2048x1536   | 2048x1536   |
| <b>Frame Rate</b>          | 216 FPS   | 216 FPS   |
| <b>Megapixels</b>          | 3.2 MP  | 3.2 MP  |
| <b>Chroma</b>              | Mono  | Color   |
| <b>Sensor</b>              | Sony IMX252, CMOS, 1/1.8" <sup>μ</sup>                                  | Sony IMX252, CMOS, 1/1.8" <sup>μ</sup>  |
| <b>Readout Method</b>      | Global shutter  | Global shutter  |
| <b>Pixel Size</b>          | 3.45 μm   | 3.45 μm   |
| <b>Lens Mount</b>          | C-mount   | C-mount   |
| <b>ADC</b>                 | 8-bit / 10-bit / 12-bit   | 8-bit / 10-bit / 12-bit   |
| <b>Minimum Frame Rate</b>  | 1 FPS   | 1 FPS   |
| <b>Gain Range</b>          | 0.0 to 47.9943 dB   | 0.0 to 47.9943 dB   |
| <b>Exposure Range</b>      | 17.0 μs to 30.0 S   | 17.0 μs to 30.0 S   |
| <b>Acquisition Mode</b>    | Continuous, Single Frame, Multi Frame                                   | Continuous, Single Frame, Multi Frame   |
| <b>Partial Image Modes</b> | Pixel binning, decimation, ROI  | Pixel binning, decimation, ROI  |
| <b>Image Processing</b>    | Gamma, lookup table, pixel correction, target grey value, and sharpness | Color correction matrix, gamma, lookup table, pixel correction, white balance, target grey value, saturation, and sharpness |
| <b>Sequencer</b>           | Up to 8 sets using 2 features   | Up to 8 sets using 2 features   |
| <b>PTP Support</b>         | Yes   | Yes   |
| <b>Image Buffer</b>        | 240 MB, maximum 1 image   | 240 MB, maximum 1 image   |
| <b>User Sets</b>           | 2 user configuration sets for custom camera settings                    | 2 user configuration sets for custom camera settings  |
| <b>Flash Memory</b>        | 4 MB non-volatile memory  | 4 MB non-volatile memory  |

|                                | Oryx ORX-10G-32S4M  | Oryx ORX-10G-32S4C  |
|--------------------------------|---|---|
| <b>Opto-isolated I/O</b>       | 2 input, 2 output   | 2 input, 2 output   |
| <b>Non-isolated I/O</b>        | 2 bi-directional  | 2 bi-directional  |
| <b>Serial Port</b>             | 1 (over non-isolated I/O)   | 1 (over non-isolated I/O)   |
| <b>Auxiliary Output</b>        | 3.3 V, 150 mA maximum   | 3.3 V, 150 mA maximum   |
| <b>Interface</b>               | 10 GigE   | 10 GigE   |
| <b>Power Requirements</b>      | Externally powered over GPIO (12 - 24 V)                              | Externally powered over GPIO (12 - 24 V)                              |
| <b>Power Consumption</b>       | Maximum: 11.8 W, Nominal: 11.3 W, GPIO power only                     | Maximum: 11.8 W, Nominal: 11.3 W, GPIO power only                     |
| <b>Dimensions/Mass</b>         | ORX-10GS-32S4: 60 mm x 60 mm x 64 mm / 386 g                          | ORX-10GS-32S4: 60 mm x 60 mm x 64 mm / 386 g                          |
| <b>Machine Vision Standard</b> | GigE Vision v1.2  | GigE Vision v1.2  |
| <b>Compliance</b>              | CE, FCC, RoHS, REACH. The ECCN for this product is: EAR099            | CE, FCC, RoHS, REACH. The ECCN for this product is: EAR099            |
| <b>Temperature Celsius</b>     | Operating: 0-70 (case) / Storage: -30-60 (ambient)                    | Operating: 0-70 (case) / Storage: -30-60 (ambient)                    |
| <b>Humidity Percent</b>        | Operating: 20-80 (no condensation) / Storage: 20-95 (no condensation) | Operating: 20-80 (no condensation) / Storage: 20-95 (no condensation) |
| <b>Warranty</b>                | 3 years   | 3 years   |

## 2.2 Oryx ORX-10G-32S4M Supported Pixel Formats

| 8-bit | 10-bit  | 12-bit       | 16-bit |
|-------|---------|--------------|--------|
| mono8 | mono10p | mono12p      | mono16 |
|       |         | mono12packed |        |
|       |         | mono10packed |        |

## 2.3 Oryx ORX-10G-32S4M Frame Rate Table

| Width | Height | Mono 8 (8-bit) | Mono10p (10-bit) | Mono12p (12-bit) | Mono16 (16-bit) | ISP | Binning Horizontal | Binning Vertical | Decimation Horizontal | Decimation Vertical | ADC    |
|-------|--------|----------------|------------------|------------------|-----------------|-----|--------------------|------------------|-----------------------|---------------------|--------|
| 2048  | 1536   | 216            | 216              | 216              | 141             | Off | 1xSensor/1xSP      | 1xSensor/1xSP    | 1xSensor              | 1xSensor            | 8-bit  |
| 1920  | 1200   | 273            | 273              | 273              | 199             | Off | 1xSensor/1xSP      | 1xSensor/1xSP    | 1xSensor              | 1xSensor            | 8-bit  |
| 800   | 600    | 528            | 528              | 528              | 528             | Off | 1xSensor/1xSP      | 1xSensor/1xSP    | 1xSensor              | 1xSensor            | 8-bit  |
| 600   | 800    | 403            | 403              | 403              | 403             | Off | 1xSensor/1xSP      | 1xSensor/1xSP    | 1xSensor              | 1xSensor            | 8-bit  |
| 640   | 480    | 650            | 650              | 650              | 649             | Off | 1xSensor/1xSP      | 1xSensor/1xSP    | 1xSensor              | 1xSensor            | 8-bit  |
| 480   | 640    | 497            | 497              | 497              | 497             | Off | 1xSensor/1xSP      | 1xSensor/1xSP    | 1xSensor              | 1xSensor            | 8-bit  |
| 320   | 240    | 998            | 998              | 998              | 998             | Off | 1xSensor/1xSP      | 1xSensor/1xSP    | 1xSensor              | 1xSensor            | 8-bit  |
| 240   | 320    | 935            | 935              | 935              | 935             | Off | 1xSensor/1xSP      | 1xSensor/1xSP    | 1xSensor              | 1xSensor            | 8-bit  |
| 2048  | 1536   | 191            | 191              | 191              | 149             | Off | 1xSensor/1xSP      | 1xSensor/1xSP    | 1xSensor              | 1xSensor            | 10-bit |
| 1920  | 1200   | 242            | 242              | 242              | 211             | Off | 1xSensor/1xSP      | 1xSensor/1xSP    | 1xSensor              | 1xSensor            | 10-bit |
| 800   | 600    | 468            | 468              | 468              | 468             | Off | 1xSensor/1xSP      | 1xSensor/1xSP    | 1xSensor              | 1xSensor            | 10-bit |
| 600   | 800    | 357            | 357              | 357              | 357             | Off | 1xSensor/1xSP      | 1xSensor/1xSP    | 1xSensor              | 1xSensor            | 10-bit |
| 640   | 480    | 576            | 576              | 576              | 576             | Off | 1xSensor/1xSP      | 1xSensor/1xSP    | 1xSensor              | 1xSensor            | 10-bit |
| 480   | 640    | 441            | 441              | 441              | 441             | Off | 1xSensor/1xSP      | 1xSensor/1xSP    | 1xSensor              | 1xSensor            | 10-bit |
| 320   | 240    | 999            | 999              | 999              | 999             | Off | 1xSensor/1xSP      | 1xSensor/1xSP    | 1xSensor              | 1xSensor            | 10-bit |
| 240   | 320    | 829            | 829              | 829              | 829             | Off | 1xSensor/1xSP      | 1xSensor/1xSP    | 1xSensor              | 1xSensor            | 10-bit |
| 2048  | 1536   | 118            | 118              | 118              | 118             | Off | 1xSensor/1xSP      | 1xSensor/1xSP    | 1xSensor              | 1xSensor            | 12-bit |
| 1920  | 1200   | 150            | 150              | 150              | 150             | Off | 1xSensor/1xSP      | 1xSensor/1xSP    | 1xSensor              | 1xSensor            | 12-bit |

| Width | Height | Mono 8 (8-bit) | Mono10p (10-bit) | Mono12p (12-bit) | Mono16 (16-bit) | ISP | Binning Horizontal | Binning Vertical | Decimation Horizontal | Decimation Vertical | ADC    |
|-------|--------|----------------|------------------|------------------|-----------------|-----|--------------------|------------------|-----------------------|---------------------|--------|
| 800   | 600    | 291            | 291              | 291              | 291             | Off | 1xSensor/1xSP      | 1xSensor/1xSP    | 1xSensor              | 1xSensor            | 12-bit |
| 600   | 800    | 222            | 222              | 222              | 222             | Off | 1xSensor/1xSP      | 1xSensor/1xSP    | 1xSensor              | 1xSensor            | 12-bit |
| 640   | 480    | 357            | 357              | 357              | 357             | Off | 1xSensor/1xSP      | 1xSensor/1xSP    | 1xSensor              | 1xSensor            | 12-bit |
| 480   | 640    | 274            | 274              | 274              | 274             | Off | 1xSensor/1xSP      | 1xSensor/1xSP    | 1xSensor              | 1xSensor            | 12-bit |
| 320   | 240    | 660            | 660              | 660              | 660             | Off | 1xSensor/1xSP      | 1xSensor/1xSP    | 1xSensor              | 1xSensor            | 12-bit |
| 240   | 320    | 515            | 515              | 515              | 515             | Off | 1xSensor/1xSP      | 1xSensor/1xSP    | 1xSensor              | 1xSensor            | 12-bit |
| 2048  | 1536   | 150            | 150              | 150              | 150             | On  | 1xSensor/1xSP      | 1xSensor/1xSP    | 1xSensor              | 1xSensor            | 8-bit  |
| 1920  | 1200   | 190            | 190              | 190              | 190             | On  | 1xSensor/1xSP      | 1xSensor/1xSP    | 1xSensor              | 1xSensor            | 8-bit  |
| 800   | 600    | 367            | 367              | 367              | 367             | On  | 1xSensor/1xSP      | 1xSensor/1xSP    | 1xSensor              | 1xSensor            | 8-bit  |
| 600   | 800    | 280            | 280              | 280              | 280             | On  | 1xSensor/1xSP      | 1xSensor/1xSP    | 1xSensor              | 1xSensor            | 8-bit  |
| 640   | 480    | 451            | 451              | 451              | 451             | On  | 1xSensor/1xSP      | 1xSensor/1xSP    | 1xSensor              | 1xSensor            | 8-bit  |
| 480   | 640    | 345            | 345              | 345              | 345             | On  | 1xSensor/1xSP      | 1xSensor/1xSP    | 1xSensor              | 1xSensor            | 8-bit  |
| 320   | 240    | 832            | 832              | 832              | 832             | On  | 1xSensor/1xSP      | 1xSensor/1xSP    | 1xSensor              | 1xSensor            | 8-bit  |
| 240   | 320    | 649            | 649              | 649              | 649             | On  | 1xSensor/1xSP      | 1xSensor/1xSP    | 1xSensor              | 1xSensor            | 8-bit  |
| 2048  | 1536   | 150            | 150              | 150              | 150             | On  | 1xSensor/1xSP      | 1xSensor/1xSP    | 1xSensor              | 1xSensor            | 10-bit |
| 1920  | 1200   | 190            | 190              | 190              | 190             | On  | 1xSensor/1xSP      | 1xSensor/1xSP    | 1xSensor              | 1xSensor            | 10-bit |
| 800   | 600    | 367            | 367              | 367              | 367             | On  | 1xSensor/1xSP      | 1xSensor/1xSP    | 1xSensor              | 1xSensor            | 10-bit |
| 600   | 800    | 280            | 280              | 280              | 280             | On  | 1xSensor/1xSP      | 1xSensor/1xSP    | 1xSensor              | 1xSensor            | 10-bit |

| Width | Height | Mono 8 (8-bit) | Mono10p (10-bit) | Mono12p (12-bit) | Mono16 (16-bit) | ISP | Binning Horizontal | Binning Vertical | Decimation Horizontal | Decimation Vertical | ADC    |
|-------|--------|----------------|------------------|------------------|-----------------|-----|--------------------|------------------|-----------------------|---------------------|--------|
| 640   | 480    | 451            | 451              | 451              | 451             | On  | 1xSensor/1x1 SP    | 1xSensor/1x1 SP  | 1xSensor              | 1xSensor            | 10-bit |
| 480   | 640    | 345            | 345              | 345              | 345             | On  | 1xSensor/1x1 SP    | 1xSensor/1x1 SP  | 1xSensor              | 1xSensor            | 10-bit |
| 320   | 240    | 832            | 832              | 832              | 832             | On  | 1xSensor/1x1 SP    | 1xSensor/1x1 SP  | 1xSensor              | 1xSensor            | 10-bit |
| 240   | 320    | 649            | 649              | 649              | 649             | On  | 1xSensor/1x1 SP    | 1xSensor/1x1 SP  | 1xSensor              | 1xSensor            | 10-bit |
| 2048  | 1536   | 118            | 118              | 118              | 118             | On  | 1xSensor/1x1 SP    | 1xSensor/1x1 SP  | 1xSensor              | 1xSensor            | 12-bit |
| 1920  | 1200   | 150            | 150              | 150              | 150             | On  | 1xSensor/1x1 SP    | 1xSensor/1x1 SP  | 1xSensor              | 1xSensor            | 12-bit |
| 800   | 600    | 291            | 291              | 291              | 291             | On  | 1xSensor/1x1 SP    | 1xSensor/1x1 SP  | 1xSensor              | 1xSensor            | 12-bit |
| 600   | 800    | 222            | 222              | 222              | 222             | On  | 1xSensor/1x1 SP    | 1xSensor/1x1 SP  | 1xSensor              | 1xSensor            | 12-bit |
| 640   | 480    | 357            | 357              | 357              | 357             | On  | 1xSensor/1x1 SP    | 1xSensor/1x1 SP  | 1xSensor              | 1xSensor            | 12-bit |
| 480   | 640    | 274            | 274              | 274              | 274             | On  | 1xSensor/1x1 SP    | 1xSensor/1x1 SP  | 1xSensor              | 1xSensor            | 12-bit |
| 320   | 240    | 660            | 660              | 660              | 660             | On  | 1xSensor/1x1 SP    | 1xSensor/1x1 SP  | 1xSensor              | 1xSensor            | 12-bit |
| 240   | 320    | 515            | 515              | 515              | 515             | On  | 1xSensor/1x1 SP    | 1xSensor/1x1 SP  | 1xSensor              | 1xSensor            | 12-bit |
| 1024  | 768    | 421            | 421              | 421              | 421             | Off | 1xSensor/1x1 SP    | 1xSensor/1x1 SP  | 2xSensor              | 2xSensor            | 8-bit  |
| 1024  | 768    | 373            | 373              | 373              | 373             | Off | 1xSensor/1x1 SP    | 1xSensor/1x1 SP  | 2xSensor              | 2xSensor            | 10-bit |
| 1024  | 768    | 232            | 232              | 232              | 232             | Off | 1xSensor/1x1 SP    | 1xSensor/1x1 SP  | 2xSensor              | 2xSensor            | 12-bit |
| 1024  | 768    | 421            | 421              | 421              | 421             | On  | 1xSensor/1x1 SP    | 1xSensor/1x1 SP  | 2xSensor              | 2xSensor            | 8-bit  |
| 1024  | 768    | 373            | 373              | 373              | 373             | On  | 1xSensor/1x1 SP    | 1xSensor/1x1 SP  | 2xSensor              | 2xSensor            | 10-bit |
| 1024  | 768    | 232            | 232              | 232              | 232             | On  | 1xSensor/1x1 SP    | 1xSensor/1x1 SP  | 2xSensor              | 2xSensor            | 12-bit |

| Width | Height | Mono 8 (8-bit) | Mono10p (10-bit) | Mono12p (12-bit) | Mono16 (16-bit) | ISP | Binning Horizontal | Binning Vertical | Decimation Horizontal | Decimation Vertical | ADC    |
|-------|--------|----------------|------------------|------------------|-----------------|-----|--------------------|------------------|-----------------------|---------------------|--------|
| 1024  | 768    | 150            | 150              | 150              | 150             | On  | 1xSensor/2x1 SP    | 1xSensor/2x1 SP  | 1xSensor              | 1xSensor            | 8-bit  |
| 1024  | 768    | 150            | 150              | 150              | 150             | On  | 1xSensor/2x1 SP    | 1xSensor/2x1 SP  | 1xSensor              | 1xSensor            | 10-bit |
| 1024  | 768    | 118            | 118              | 118              | 118             | On  | 1xSensor/2x1 SP    | 1xSensor/2x1 SP  | 1xSensor              | 1xSensor            | 12-bit |
| 512   | 384    | 150            | 150              | 150              | 150             | On  | 1xSensor/4x1 SP    | 1xSensor/4x1 SP  | 1xSensor              | 1xSensor            | 8-bit  |
| 512   | 384    | 150            | 150              | 150              | 150             | On  | 1xSensor/4x1 SP    | 1xSensor/4x1 SP  | 1xSensor              | 1xSensor            | 10-bit |
| 512   | 384    | 118            | 118              | 118              | 118             | On  | 1xSensor/4x1 SP    | 1xSensor/4x1 SP  | 1xSensor              | 1xSensor            | 12-bit |

## 2.4 Oryx ORX-10G-32S4C Supported Pixel Formats

| 8-bit    | 10-bit     | 12-bit          | 16-bit       | 24-bit       | 32-bit |
|----------|------------|-----------------|--------------|--------------|--------|
| bayerrg8 | bayerrg10p | ycbcr411_8      | ycbcr422_8   | bgr8         | bgra8  |
| mono8    | mono10p    | bayerrg12p      | yuv422packed | ycbcr8       |        |
|          |            | mono12p         | bayerrg16    | yuv444packed |        |
|          |            | yuv411packed    | mono16       | rgb8packed   |        |
|          |            | bayerrg12packed |              |              |        |
|          |            | mono12packed    |              |              |        |
|          |            | bayerrg10packed |              |              |        |
|          |            | mono10packed    |              |              |        |

## 2.5 Oryx ORX-10G-32S4C Frame Rate Table

| Width | Height | Bayer RG8 (8-bit) | BayerRG 10p (10-bit) | BayerRG 12p (12-bit) | BayerRG 16 (16-bit) | BGR 8 (24-bit) | BGR a8 (32-bit) | ISP | Binning Horizontal | Binning Vertical   | Decimation Horizontal | Decimation Vertical | ADC    |
|-------|--------|-------------------|----------------------|----------------------|---------------------|----------------|-----------------|-----|--------------------|--------------------|-----------------------|---------------------|--------|
| 2048  | 1536   | 216               | 216                  | 216                  | 141                 | N/A            | N/A             | Off | 1xSensor/<br>1xISP | 1xSensor/<br>1xISP | 1xSensor              | 1xSensor            | 8-bit  |
| 1920  | 1200   | 273               | 273                  | 273                  | 199                 | N/A            | N/A             | Off | 1xSensor/<br>1xISP | 1xSensor/<br>1xISP | 1xSensor              | 1xSensor            | 8-bit  |
| 800   | 600    | 528               | 528                  | 528                  | 528                 | N/A            | N/A             | Off | 1xSensor/<br>1xISP | 1xSensor/<br>1xISP | 1xSensor              | 1xSensor            | 8-bit  |
| 600   | 800    | 403               | 403                  | 403                  | 403                 | N/A            | N/A             | Off | 1xSensor/<br>1xISP | 1xSensor/<br>1xISP | 1xSensor              | 1xSensor            | 8-bit  |
| 640   | 480    | 650               | 650                  | 650                  | 650                 | N/A            | N/A             | Off | 1xSensor/<br>1xISP | 1xSensor/<br>1xISP | 1xSensor              | 1xSensor            | 8-bit  |
| 480   | 640    | 497               | 497                  | 497                  | 497                 | N/A            | N/A             | Off | 1xSensor/<br>1xISP | 1xSensor/<br>1xISP | 1xSensor              | 1xSensor            | 8-bit  |
| 320   | 240    | 998               | 998                  | 998                  | 998                 | N/A            | N/A             | Off | 1xSensor/<br>1xISP | 1xSensor/<br>1xISP | 1xSensor              | 1xSensor            | 8-bit  |
| 240   | 320    | 935               | 935                  | 935                  | 935                 | N/A            | N/A             | Off | 1xSensor/<br>1xISP | 1xSensor/<br>1xISP | 1xSensor              | 1xSensor            | 8-bit  |
| 2048  | 1536   | 191               | 191                  | 191                  | 149                 | N/A            | N/A             | Off | 1xSensor/<br>1xISP | 1xSensor/<br>1xISP | 1xSensor              | 1xSensor            | 10-bit |
| 1920  | 1200   | 242               | 242                  | 242                  | 211                 | N/A            | N/A             | Off | 1xSensor/<br>1xISP | 1xSensor/<br>1xISP | 1xSensor              | 1xSensor            | 10-bit |
| 800   | 600    | 468               | 468                  | 468                  | 468                 | N/A            | N/A             | Off | 1xSensor/<br>1xISP | 1xSensor/<br>1xISP | 1xSensor              | 1xSensor            | 10-bit |
| 600   | 800    | 357               | 357                  | 357                  | 357                 | N/A            | N/A             | Off | 1xSensor/<br>1xISP | 1xSensor/<br>1xISP | 1xSensor              | 1xSensor            | 10-bit |
| 640   | 480    | 576               | 576                  | 576                  | 576                 | N/A            | N/A             | Off | 1xSensor/<br>1xISP | 1xSensor/<br>1xISP | 1xSensor              | 1xSensor            | 10-bit |
| 480   | 640    | 441               | 441                  | 441                  | 441                 | N/A            | N/A             | Off | 1xSensor/<br>1xISP | 1xSensor/<br>1xISP | 1xSensor              | 1xSensor            | 10-bit |
| 320   | 240    | 999               | 999                  | 999                  | 999                 | N/A            | N/A             | Off | 1xSensor/<br>1xISP | 1xSensor/<br>1xISP | 1xSensor              | 1xSensor            | 10-bit |



| Width | Height | Bayer RG8 (8-bit) | BayerRG 10p (10-bit) | BayerRG 12p (12-bit) | BayerRG 16 (16-bit) | BGR8 (24-bit) | BGRa8 (32-bit) | ISP | Binning Horizontal | Binning Vertical   | Decimation Horizontal | Decimation Vertical | ADC    |
|-------|--------|-------------------|----------------------|----------------------|---------------------|---------------|----------------|-----|--------------------|--------------------|-----------------------|---------------------|--------|
|       |        |                   |                      |                      |                     |               |                |     |                    |                    |                       |                     | bit    |
| 240   | 320    | 829               | 829                  | 829                  | 829                 | N/A           | N/A            | Off | 1xSensor/<br>1xISP | 1xSensor/<br>1xISP | 1xSensor              | 1xSensor            | 10-bit |
| 2048  | 1536   | 118               | 118                  | 118                  | 118                 | N/A           | N/A            | Off | 1xSensor/<br>1xISP | 1xSensor/<br>1xISP | 1xSensor              | 1xSensor            | 12-bit |
| 1920  | 1200   | 150               | 150                  | 150                  | 150                 | N/A           | N/A            | Off | 1xSensor/<br>1xISP | 1xSensor/<br>1xISP | 1xSensor              | 1xSensor            | 12-bit |
| 800   | 600    | 291               | 291                  | 291                  | 291                 | N/A           | N/A            | Off | 1xSensor/<br>1xISP | 1xSensor/<br>1xISP | 1xSensor              | 1xSensor            | 12-bit |
| 600   | 800    | 222               | 222                  | 222                  | 222                 | N/A           | N/A            | Off | 1xSensor/<br>1xISP | 1xSensor/<br>1xISP | 1xSensor              | 1xSensor            | 12-bit |
| 640   | 480    | 357               | 357                  | 357                  | 357                 | N/A           | N/A            | Off | 1xSensor/<br>1xISP | 1xSensor/<br>1xISP | 1xSensor              | 1xSensor            | 12-bit |
| 480   | 640    | 274               | 274                  | 274                  | 274                 | N/A           | N/A            | Off | 1xSensor/<br>1xISP | 1xSensor/<br>1xISP | 1xSensor              | 1xSensor            | 12-bit |
| 320   | 240    | 660               | 660                  | 660                  | 660                 | N/A           | N/A            | Off | 1xSensor/<br>1xISP | 1xSensor/<br>1xISP | 1xSensor              | 1xSensor            | 12-bit |
| 240   | 320    | 515               | 515                  | 515                  | 515                 | N/A           | N/A            | Off | 1xSensor/<br>1xISP | 1xSensor/<br>1xISP | 1xSensor              | 1xSensor            | 12-bit |
| 2048  | 1536   | 150               | 150                  | 150                  | 150                 | 92            | 63             | On  | 1xSensor/<br>1xISP | 1xSensor/<br>1xISP | 1xSensor              | 1xSensor            | 8-bit  |
| 1920  | 1200   | 190               | 190                  | 190                  | 190                 | 130           | 87             | On  | 1xSensor/<br>1xISP | 1xSensor/<br>1xISP | 1xSensor              | 1xSensor            | 8-bit  |
| 800   | 600    | 367               | 367                  | 367                  | 367                 | 367           | 367            | On  | 1xSensor/<br>1xISP | 1xSensor/<br>1xISP | 1xSensor              | 1xSensor            | 8-bit  |
| 600   | 800    | 280               | 280                  | 280                  | 280                 | 280           | 280            | On  | 1xSensor/<br>1xISP | 1xSensor/<br>1xISP | 1xSensor              | 1xSensor            | 8-bit  |

| Width | Height | Bayer RG8 (8-bit) | BayerRG 10p (10-bit) | BayerRG 12p (12-bit) | BayerRG 16 (16-bit) | BGR8 (24-bit) | BGRa8 (32-bit) | ISP | Binning Horizontal | Binning Vertical   | Decimation Horizontal | Decimation Vertical | ADC    |
|-------|--------|-------------------|----------------------|----------------------|---------------------|---------------|----------------|-----|--------------------|--------------------|-----------------------|---------------------|--------|
| 640   | 480    | 451               | 451                  | 451                  | 451                 | 451           | 451            | On  | 1xSensor/<br>1xISP | 1xSensor/<br>1xISP | 1xSensor              | 1xSensor            | 8-bit  |
| 480   | 640    | 345               | 345                  | 345                  | 345                 | 345           | 345            | On  | 1xSensor/<br>1xISP | 1xSensor/<br>1xISP | 1xSensor              | 1xSensor            | 8-bit  |
| 320   | 240    | 832               | 832                  | 832                  | 832                 | 832           | 832            | On  | 1xSensor/<br>1xISP | 1xSensor/<br>1xISP | 1xSensor              | 1xSensor            | 8-bit  |
| 240   | 320    | 649               | 649                  | 649                  | 649                 | 649           | 649            | On  | 1xSensor/<br>1xISP | 1xSensor/<br>1xISP | 1xSensor              | 1xSensor            | 8-bit  |
| 208   | 156    | 150               | 150                  | 150                  | 150                 | 92            | 63             | On  | 1xSensor/<br>1xISP | 1xSensor/<br>1xISP | 1xSensor              | 1xSensor            | 10-bit |
| 192   | 120    | 190               | 190                  | 190                  | 190                 | 130           | 87             | On  | 1xSensor/<br>1xISP | 1xSensor/<br>1xISP | 1xSensor              | 1xSensor            | 10-bit |
| 800   | 600    | 367               | 367                  | 367                  | 367                 | 367           | 367            | On  | 1xSensor/<br>1xISP | 1xSensor/<br>1xISP | 1xSensor              | 1xSensor            | 10-bit |
| 600   | 800    | 280               | 280                  | 280                  | 280                 | 280           | 280            | On  | 1xSensor/<br>1xISP | 1xSensor/<br>1xISP | 1xSensor              | 1xSensor            | 10-bit |
| 640   | 480    | 451               | 451                  | 451                  | 451                 | 451           | 451            | On  | 1xSensor/<br>1xISP | 1xSensor/<br>1xISP | 1xSensor              | 1xSensor            | 10-bit |
| 480   | 640    | 345               | 345                  | 345                  | 345                 | 345           | 345            | On  | 1xSensor/<br>1xISP | 1xSensor/<br>1xISP | 1xSensor              | 1xSensor            | 10-bit |
| 320   | 240    | 832               | 832                  | 832                  | 832                 | 832           | 832            | On  | 1xSensor/<br>1xISP | 1xSensor/<br>1xISP | 1xSensor              | 1xSensor            | 10-bit |
| 240   | 320    | 649               | 649                  | 649                  | 649                 | 649           | 649            | On  | 1xSensor/<br>1xISP | 1xSensor/<br>1xISP | 1xSensor              | 1xSensor            | 10-bit |
| 208   | 156    | 118               | 118                  | 118                  | 118                 | 103           | 68             | On  | 1xSensor/<br>1xISP | 1xSensor/<br>1xISP | 1xSensor              | 1xSensor            | 12-bit |
| 192   | 120    | 150               | 150                  | 150                  | 150                 | 147           | 95             | On  | 1xSensor/<br>1xISP | 1xSensor/<br>1xISP | 1xSensor              | 1xSensor            | 1      |

| Width | Height | Bayer RG8 (8-bit) | BayerRG 10p (10-bit) | BayerRG 12p (12-bit) | BayerRG16 (16-bit) | BGR8 (24-bit) | BGRa8 (32-bit) | ISP | Binning Horizontal | Binning Vertical   | Decimation Horizontal | Decimation Vertical | ADC    |
|-------|--------|-------------------|----------------------|----------------------|--------------------|---------------|----------------|-----|--------------------|--------------------|-----------------------|---------------------|--------|
| 0     | 0      |                   |                      |                      |                    |               |                | on  | 1xISP              | 1xISP              | r                     | r                   | 2-bit  |
| 800   | 600    | 291               | 291                  | 291                  | 291                | 291           | 291            | on  | 1xSensor/<br>1xISP | 1xSensor/<br>1xISP | 1xSensor              | 1xSensor            | 12-bit |
| 600   | 800    | 222               | 222                  | 222                  | 222                | 222           | 222            | on  | 1xSensor/<br>1xISP | 1xSensor/<br>1xISP | 1xSensor              | 1xSensor            | 12-bit |
| 640   | 480    | 357               | 357                  | 357                  | 357                | 357           | 357            | on  | 1xSensor/<br>1xISP | 1xSensor/<br>1xISP | 1xSensor              | 1xSensor            | 12-bit |
| 480   | 640    | 274               | 274                  | 274                  | 274                | 274           | 274            | on  | 1xSensor/<br>1xISP | 1xSensor/<br>1xISP | 1xSensor              | 1xSensor            | 12-bit |
| 320   | 240    | 660               | 660                  | 660                  | 660                | 660           | 660            | on  | 1xSensor/<br>1xISP | 1xSensor/<br>1xISP | 1xSensor              | 1xSensor            | 12-bit |
| 240   | 320    | 515               | 515                  | 515                  | 515                | 515           | 515            | on  | 1xSensor/<br>1xISP | 1xSensor/<br>1xISP | 1xSensor              | 1xSensor            | 12-bit |
| 1024  | 768    | 421               | 421                  | 421                  | 421                | N/A           | N/A            | Off | 1xSensor/<br>1xISP | 1xSensor/<br>1xISP | 2xSensor              | 2xSensor            | 8-bit  |
| 1024  | 768    | 373               | 373                  | 373                  | 373                | N/A           | N/A            | Off | 1xSensor/<br>1xISP | 1xSensor/<br>1xISP | 2xSensor              | 2xSensor            | 10-bit |
| 1024  | 768    | 232               | 232                  | 232                  | 232                | N/A           | N/A            | Off | 1xSensor/<br>1xISP | 1xSensor/<br>1xISP | 2xSensor              | 2xSensor            | 12-bit |
| 1024  | 768    | 421               | 421                  | 421                  | 421                | 421           | 283            | on  | 1xSensor/<br>1xISP | 1xSensor/<br>1xISP | 2xSensor              | 2xSensor            | 8-bit  |
| 1024  | 768    | 373               | 373                  | 373                  | 373                | 373           | 299            | on  | 1xSensor/<br>1xISP | 1xSensor/<br>1xISP | 2xSensor              | 2xSensor            | 10-bit |
| 1024  | 768    | 232               | 232                  | 232                  | 232                | 232           | 232            | on  | 1xSensor/<br>1xISP | 1xSensor/<br>1xISP | 2xSensor              | 2xSensor            | 12-bit |

| Width | Height | Bayer RG8 (8-bit) | BayerRG 10p (10-bit) | BayerRG 12p (12-bit) | BayerRG 16 (16-bit) | BGR8 (24-bit) | BGRa8 (32-bit) | ISP | Binning Horizontal | Binning Vertical   | Decimation Horizontal | Decimation Vertical | ADC    |
|-------|--------|-------------------|----------------------|----------------------|---------------------|---------------|----------------|-----|--------------------|--------------------|-----------------------|---------------------|--------|
| 1024  | 768    | 150               | 150                  | 150                  | 150                 | 150           | 150            | On  | 1xSensor/<br>2xISP | 1xSensor/<br>2xISP | 1xSensor              | 1xSensor            | 8-bit  |
| 1024  | 768    | 150               | 150                  | 150                  | 150                 | 150           | 150            | On  | 1xSensor/<br>2xISP | 1xSensor/<br>2xISP | 1xSensor              | 1xSensor            | 10-bit |
| 1024  | 768    | 118               | 118                  | 118                  | 118                 | 118           | 118            | On  | 1xSensor/<br>2xISP | 1xSensor/<br>2xISP | 1xSensor              | 1xSensor            | 12-bit |
| 512   | 384    | 150               | 150                  | 150                  | 150                 | 150           | 150            | On  | 1xSensor/<br>4xISP | 1xSensor/<br>4xISP | 1xSensor              | 1xSensor            | 8-bit  |
| 512   | 384    | 150               | 150                  | 150                  | 150                 | 150           | 150            | On  | 1xSensor/<br>4xISP | 1xSensor/<br>4xISP | 1xSensor              | 1xSensor            | 10-bit |
| 512   | 384    | 118               | 118                  | 118                  | 118                 | 118           | 118            | On  | 1xSensor/<br>4xISP | 1xSensor/<br>4xISP | 1xSensor              | 1xSensor            | 12-bit |

## 3 Acquisition Control

### 3.1 Acquisition and Frame Rate

There are three acquisition modes:

**Continuous** - acquires images continuously. This is the default mode.

**Multi Frame** - acquires a specified number of images before stopping acquisition.

**Single Frame** - acquires 1 image before stopping acquisition.

Use [AcquisitionMode](#) to select your mode. If you select MultiFrame, use [AcquisitionFrameCount](#) to specify the number of images to acquire.

Use [AcquisitionStart](#) and [AcquisitionStop](#) to start and stop acquiring images with the selected mode.

The Acquisition Frame Rate can be manually or automatically controlled. Use [AcquisitionFrameRateEnable](#) to set this On (manual control) or Off (automatic control). By default, this is Off. If you select manual control, use [AcquisitionFrameRate](#) to specify a frame rate.

The [ResultingFrameRate](#) reports the actual frame rate at which the camera is streaming. If this does not equal the Acquisition Frame Rate it is because the Exposure Time is greater than the frame time.

### 3.2 Exposure Time Modes

There are two exposure time modes:

**Timed** - exposure time is a specified value. This is the default mode.

**TriggerWidth** - exposure time is controlled by the trigger signal.

Use [ExposureMode](#) to make a selection.

When ExposureMode is set to Timed, exposure time can be manually or automatically controlled.

For manual control, set [ExposureAuto](#) to Off. Use the [ExposureTime](#) control to set the exposure time in microseconds.

For automatic control, set ExposureAuto to Once or Continuous. The camera automatically adjusts the exposure to maximize the dynamic range. Once briefly enables automatic exposure to adapt the device and then sets exposure to manual control (Off). Continuous constantly adapts the device. Continuous is the default setting.

**Note:** For the [Auto Exposure feature](#), gain and/or exposure time must be set to Continuous.

#### 3.2.1 Trigger Features

Triggering allows you to acquire images at specific times when an event occurs. Triggering works with the acquisition modes and settings. By default, triggering is set to Off. To enable triggering, set [TriggerMode](#) to On.

**Trigger Type** - three options to control the start of triggering. Use [TriggerSelector](#) to select an option.

**Acquisition Start** - A trigger starts acquisition in the selected AcquisitionMode.

In Single Frame mode, the trigger acquires one image.

In Multi Frame mode, the trigger acquires the specified number of images.

In Continuous mode, the trigger acquires images until you stop acquisition.

**Frame Start** - A trigger is required for each individual image that is acquired.

In Single Frame mode, the trigger acquires one image. For each subsequent trigger you first must use AcquisitionStart to receive more images.

In Multi Frame mode, the trigger acquires the specified number of images. For each subsequent trigger you first must use AcquisitionStart to receive more images.

In Continuous mode, the trigger acquires one image. You do not have to start acquisition again for subsequent triggers.

**Frame Burst Start** - A trigger acquires a specified number of images. You do not have to start acquisition again for subsequent triggers. This mode is primarily used in Continuous mode, as Single Frame and Multi Frame settings overwrite the burst count. Use [AcquisitionBurstFrameCount](#) to specify the number of images to be acquired.

In Single Frame mode, the trigger acquires one image.

In Multi Frame mode, the trigger acquires the number of images specified in AcquisitionFrameCount.

In Continuous mode, the trigger acquires the number of images specified in AcquisitionBurstFrameCount.

**Trigger Source** - Use [TriggerSource](#) to specify the source that can signal the acquisition to acquire images. A trigger source can be one of the physical Line Inputs, User Outputs, Counters, Logic Blocks, and Software.

**Trigger Activation** - Use [TriggerActivation](#) to specify what voltage level or transition that activates a trigger. Trigger activation can be Level Low, Level High, Falling Edge, Rising Edge, or Any Edge.

**Trigger Overlap** - Use [TriggerOverlap](#) to specify whether a trigger responds while the readout of a previously acquired image is still occurring. There are two options: When set to Off, a trigger is disregarded during readout. When set to ReadOut, a trigger acquires another image during readout.

**Trigger Delay** - Use [TriggerDelay](#) to specify the time in microseconds between when the camera receives a trigger and when exposure begins for the image.

**Trigger Software** - If your trigger source is set to Software, use [TriggerSoftware](#) to perform a software trigger.

## 3.3 Summary Table

| Name                              | Interface    | Access | Visibility | Description  |
|-----------------------------------|--------------|--------|------------|--|
| <a href="#">Acquisition Mode</a>  | IEnumeration |        | Beginner   | Sets the acquisition mode of the device. Continuous: acquires images continuously. Multi Frame: acquires a specified number of images before stopping acquisition. Single Frame: acquires 1 image before stopping acquisition. |
| <a href="#">Acquisition Start</a> | ICommand     |        | Beginner   | This command starts the acquisition of images.   |
| <a href="#">Acquisition</a>       | ICommand     |        | Beginner   | This command stops the acquisition of images.  |

| Name  | Interface    | Access | Visibility | Description  |
|---|--------------|--------|------------|--|
| <a href="#">Stop</a>                                |              |        |            |  |
| <a href="#">Acquisition Frame Count</a>             | Integer      |        | Beginner   | Number of images to acquire during a multi frame acquisition.  |
| <a href="#">Acquisition Burst Frame Count</a>       | Integer      |        | Beginner   | This feature is used only if the FrameBurstStart trigger is enabled and the FrameBurstEnd trigger is disabled. Note that the total number of frames captured is also conditioned by AcquisitionFrameCount if AcquisitionMode is MultiFrame and ignored if AcquisitionMode is Single. |
| <a href="#">Exposure Mode</a>                       | IEnumeration | RW     | Beginner   | Sets the operation mode of the Exposure.   |
| <a href="#">Exposure Time</a>                       | IFloat       |        | Beginner   | Exposure time in microseconds when Exposure Mode is Timed.   |
| <a href="#">Exposure Auto</a>                       | IEnumeration |        | Beginner   | Sets the automatic exposure mode   |
| <a href="#">Acquisition Frame Rate</a>              | IFloat       |        | Beginner   | User controlled acquisition frame rate in Hertz  |
| <a href="#">Resulting Frame Rate</a>                | IFloat       | RO     | Beginner   | Resulting frame rate in Hertz. If this does not equal the Acquisition Frame Rate it is because the Exposure Time is greater than the frame time.   |
| <a href="#">Acquisition Frame Rate Enable</a>       | IBoolean     | RW     | Beginner   | If enabled, AcquisitionFrameRate can be used to manually control the frame rate.   |
| <a href="#">Acquisition Line Rate</a>               | IFloat       |        | Beginner   | Controls the rate (in Hertz) at which the Lines in a Frame are captured.   |
| <a href="#">Trigger Selector</a>                    | IEnumeration | RW     | Beginner   | Selects the type of trigger to configure.  |
| <a href="#">Trigger Mode [Trigger Selector]</a>     | IEnumeration | RW     | Beginner   | Controls whether or not trigger is active.   |
| <a href="#">Trigger Software [Trigger Selector]</a> | ICommand     | WO     | Beginner   | Generates an internal trigger if Trigger Source is set to Software.  |

| Name  | Interface    | Access | Visibility | Description   |
|---|--------------|--------|------------|---|
| <a href="#">Trigger Source [Trigger Selector]</a>     | IEnumeration | RW     | Beginner   | Specifies the internal signal or physical input line to use as the trigger source.                        |
| <a href="#">Trigger Activation [Trigger Selector]</a> | IEnumeration | RW     | Beginner   | Specifies the activation mode of the trigger.   |
| <a href="#">Trigger Overlap [Trigger Selector]</a>    | IEnumeration | RW     | Beginner   | Specifies the overlap mode of the trigger.  |
| <a href="#">Trigger Delay [Trigger Selector]</a>      | IFloat       |        | Expert     | Specifies the delay in microseconds ( $\mu$ s) to apply after the trigger reception before activating it. |
| <a href="#">Sensor Shutter Mode</a>                   | IEnumeration | RW     | Guru       | Sets the shutter mode of the device.  |

## 3.4 Acquisition Control Features

### 3.4.1 Acquisition Mode

Sets the acquisition mode of the device. Continuous: acquires images continuously. Multi Frame: acquires a specified number of images before stopping acquisition. Single Frame: acquires 1 image before stopping acquisition.

| Property          | Value           |
|-------------------|-----------------|
| <b>Name</b>       | AcquisitionMode |
| <b>Interface</b>  | IEnumeration    |
| <b>Access</b>     |                 |
| <b>Visibility</b> | Beginner        |

#### Enumeration Values

Continuous



**Enumeration Values**

|             |
|-------------|
| SingleFrame |
| MultiFrame  |

### 3.4.2 Acquisition Start

This command starts the acquisition of images.

| Property          | Value            |
|-------------------|------------------|
| <b>Name</b>       | AcquisitionStart |
| <b>Interface</b>  | ICommand         |
| <b>Access</b>     |                  |
| <b>Visibility</b> | Beginner         |

### 3.4.3 Acquisition Stop

This command stops the acquisition of images.

| Property          | Value           |
|-------------------|-----------------|
| <b>Name</b>       | AcquisitionStop |
| <b>Interface</b>  | ICommand        |
| <b>Access</b>     |                 |
| <b>Visibility</b> | Beginner        |

### 3.4.4 Acquisition Frame Count

Number of images to acquire during a multi frame acquisition.

| Property          | Value                 |
|-------------------|-----------------------|
| <b>Name</b>       | AcquisitionFrameCount |
| <b>Interface</b>  | Integer               |
| <b>Access</b>     |                       |
| <b>Unit</b>       |                       |
| <b>Visibility</b> | Beginner              |

### 3.4.5 Acquisition Burst Frame Count

This feature is used only if the FrameBurstStart trigger is enabled and the FrameBurstEnd trigger is disabled. Note that the total number of frames captured is also conditioned by AcquisitionFrameCount if AcquisitionMode is MultiFrame and ignored if AcquisitionMode is Single.

| Property          | Value                      |
|-------------------|----------------------------|
| <b>Name</b>       | AcquisitionBurstFrameCount |
| <b>Interface</b>  | Integer                    |
| <b>Access</b>     |                            |
| <b>Unit</b>       |                            |
| <b>Visibility</b> | Beginner                   |

### 3.4.6 Exposure Mode

Sets the operation mode of the Exposure.

| Property          | Value        |
|-------------------|--------------|
| <b>Name</b>       | ExposureMode |
| <b>Interface</b>  | IEnumeration |
| <b>Access</b>     | RW           |
| <b>Visibility</b> | Beginner     |

#### Enumeration Values

|                     |
|---------------------|
| <b>Timed</b>        |
| <b>TriggerWidth</b> |

### 3.4.7 Exposure Time

Exposure time in microseconds when Exposure Mode is Timed.

| Property         | Value        |
|------------------|--------------|
| <b>Name</b>      | ExposureTime |
| <b>Interface</b> | IFloat       |

| Property   | Value    |
|------------|----------|
| Access     |          |
| Unit       | us       |
| Visibility | Beginner |

### 3.4.8 Exposure Auto

Sets the automatic exposure mode

| Property   | Value        |
|------------|--------------|
| Name       | ExposureAuto |
| Interface  | IEnumeration |
| Access     |              |
| Visibility | Beginner     |

#### Enumeration Values

|            |
|------------|
| Off        |
| Once       |
| Continuous |

### 3.4.9 Acquisition Frame Rate

User controlled acquisition frame rate in Hertz

| Property   | Value                |
|------------|----------------------|
| Name       | AcquisitionFrameRate |
| Interface  | IFloat               |
| Access     |                      |
| Unit       | Hz                   |
| Visibility | Beginner             |

### 3.4.10 Resulting Frame Rate

Resulting frame rate in Hertz. If this does not equal the Acquisition Frame Rate it is because the Exposure Time is greater than the frame time.

| Property          | Value                         |
|-------------------|-------------------------------|
| <b>Name</b>       | AcquisitionResultingFrameRate |
| <b>Interface</b>  | IFloat                        |
| <b>Access</b>     | RO                            |
| <b>Unit</b>       | Hz                            |
| <b>Visibility</b> | Beginner                      |

### 3.4.11 Acquisition Frame Rate Enable

If enabled, AcquisitionFrameRate can be used to manually control the frame rate.

| Property          | Value                      |
|-------------------|----------------------------|
| <b>Name</b>       | AcquisitionFrameRateEnable |
| <b>Interface</b>  | IBoolean                   |
| <b>Access</b>     | RW                         |
| <b>Visibility</b> | Beginner                   |

### 3.4.12 Acquisition Line Rate

Controls the rate (in Hertz) at which the Lines in a Frame are captured.

| Property          | Value               |
|-------------------|---------------------|
| <b>Name</b>       | AcquisitionLineRate |
| <b>Interface</b>  | IFloat              |
| <b>Access</b>     |                     |
| <b>Unit</b>       | Hz                  |
| <b>Visibility</b> | Beginner            |

### 3.4.13 Trigger Selector

Selects the type of trigger to configure.

| Property          | Value           |
|-------------------|-----------------|
| <b>Name</b>       | TriggerSelector |
| <b>Interface</b>  | IEnumeration    |
| <b>Access</b>     | RW              |
| <b>Visibility</b> | Beginner        |

#### Enumeration Values

|                  |
|------------------|
| AcquisitionStart |
| FrameStart       |
| FrameBurstStart  |

### 3.4.14 Trigger Mode

Controls whether or not trigger is active.

| Property          | Value  |
|-------------------|--|
| <b>Name</b>       | TriggerMode <a href="#">[Trigger Selector]</a> |
| <b>Interface</b>  | IEnumeration                                   |
| <b>Access</b>     | RW   |
| <b>Visibility</b> | Beginner                                       |

#### Enumeration Values

|     |
|-----|
| Off |
| On  |

### 3.4.15 Trigger Software

Generates an internal trigger if Trigger Source is set to Software.

| Property         | Value  |
|------------------|--|
| <b>Name</b>      | TriggerSoftware <a href="#">[Trigger Selector]</a> |
| <b>Interface</b> | ICommand   |

| Property          | Value    |
|-------------------|----------|
| <b>Access</b>     | WO       |
| <b>Visibility</b> | Beginner |

### 3.4.16 Trigger Source

Specifies the internal signal or physical input line to use as the trigger source.

| Property          | Value  |
|-------------------|--|
| <b>Name</b>       | TriggerSource <a href="#">[Trigger Selector]</a> |
| <b>Interface</b>  | IEnumeration                                     |
| <b>Access</b>     | RW   |
| <b>Visibility</b> | Beginner   |

#### Enumeration Values

|               |
|---------------|
| Software      |
| Line0         |
| Line1         |
| Line2         |
| Line3         |
| Line4         |
| Line5         |
| Line6         |
| UserOutput0   |
| UserOutput1   |
| UserOutput2   |
| UserOutput3   |
| Counter0Start |
| Counter1Start |

**Enumeration Values**

|             |
|-------------|
| Counter0End |
| Counter1End |
| LogicBlock0 |
| LogicBlock1 |

### 3.4.17 Trigger Activation

Specifies the activation mode of the trigger.

| Property          | Value  |
|-------------------|--|
| <b>Name</b>       | TriggerActivation <a href="#">[Trigger Selector]</a> |
| <b>Interface</b>  | IEnumeration   |
| <b>Access</b>     | RW   |
| <b>Visibility</b> | Beginner   |

**Enumeration Values**

|             |
|-------------|
| LevelLow    |
| LevelHigh   |
| FallingEdge |
| RisingEdge  |
| AnyEdge     |

### 3.4.18 Trigger Overlap

Specifies the overlap mode of the trigger.

| Property          | Value   |
|-------------------|---|
| <b>Name</b>       | TriggerOverlap <a href="#">[Trigger Selector]</a> |
| <b>Interface</b>  | IEnumeration                                      |
| <b>Access</b>     | RW  |
| <b>Visibility</b> | Beginner  |

#### Enumeration Values

|               |
|---------------|
| Off           |
| ReadOut       |
| PreviousFrame |

### 3.4.19 Trigger Delay

Specifies the delay in microseconds ( $\mu\text{s}$ ) to apply after the trigger reception before activating it.

| Property          | Value   |
|-------------------|---|
| <b>Name</b>       | TriggerDelay <a href="#">[Trigger Selector]</a> |
| <b>Interface</b>  | IFloat  |
| <b>Access</b>     |   |
| <b>Unit</b>       | us  |
| <b>Visibility</b> | Expert  |

### 3.4.20 Sensor Shutter Mode

Sets the shutter mode of the device.

| Property          | Value             |
|-------------------|-------------------|
| <b>Name</b>       | SensorShutterMode |
| <b>Interface</b>  | IEnumeration      |
| <b>Access</b>     | RW                |
| <b>Visibility</b> | Guru              |

#### Enumeration Values

|        |
|--------|
| Global |
|--------|



## 4 Analog Control

### 4.1 Gain

Gain is the amount of amplification that is applied to a pixel by the A/D converter. An increase in gain can result in a brighter image but also an increase in noise.

Gain can be manually or automatically controlled.

Use the [Gain Selector](#) to choose which gain to control. The All selection is a total amplification across all channels (or taps).

For manual control, set [GainAuto](#) to Off. Use the [Gain](#) control to set the amplification in dB.

For automatic control, set [GainAuto](#) to Once or Continuous. The camera automatically adjusts the gain to maximize the dynamic range. Once briefly enables automatic gain to adapt the device and then sets gain back to manual control (Off). Continuous constantly adapts the device.

**Note:** For the [Auto Exposure feature](#), gain and/or exposure time must be set to Once or Continuous.

### 4.2 Black Level

The Black Level feature controls the offset applied to the video signal. It determines the image average when there is no light reaching the sensor.

There are two methods of applying black level: **Analog** and **Digital**. The analog black level controls the offset applied during analog-to-digital (A/D) conversion. The digital black level is an offset applied after the image has been digitized.

The sum of the analog and digital black levels can be set and read by setting [Black Level Selector](#) to **All** and then using the [Black Level](#) feature to enter or view the percentage offset.

Only the total black level (All) can be set by the user. Based on the value of black level All, the analog and digital black levels are automatically set to achieve the requested total black level.

### 4.3 White Balance - Color Models

White balance compensates for color shifts caused by different lighting conditions. White balance is specified as the gains of the **Red** and **Blue** channels relative to **Green**. For example, if the blue balance ratio is set to 1.5 then 50% more gain is applied to the blue channel than the green channel. White balance can be manually or automatically controlled.

For manual control, set [White Balance Auto](#) to Off. Use the [Balance Ratio Selector](#) to select either the Red or Blue channel. Use the [Balance Ratio](#) to specify a value for that channel. To disable white balance, set both red and blue balance ratios to 1.0.

For automatic control, set [White Balance Auto](#) to Once or Continuous. The camera automatically adjusts the red and blue balance ratios to achieve good color balance. Once runs for a number of iterations and then sets White Balance Auto to Off. Continuous adjusts the values continually if the algorithm determines that the colors are imbalanced. A number of parameters that affect automatic white balance are available in the [AutoAlgorithmControl](#) category.

The white balance can also be modified by selecting a light source with [RGB Transform Light Source](#). Selecting a light source modifies both the red and blue balance ratio values as well as the active RGBtoRGB [Color Transformation](#), to achieve good color for the specified lighting condition.

## 4.4 Gamma

The [Gamma](#) feature controls the gamma correction applied to pixel intensity. The equation used is:

$$P' = P^{\text{Gamma}}$$

where  $P$  is the input pixel value and  $P'$  is the pixel value after gamma correction. Note that the value for Gamma is defined as the power applied to the pixel value, and not the gamma of the display. If a display with a gamma of 2.0 is used, the image gamma can be set to 0.5 to compensate. For sRGB output, Gamma should be set to 0.4545 (1/2.2).

If linear output data is required, disable gamma by setting [GammaEnable](#) to 0.

Gamma and the Pixel [Lookup Table](#) (LUT) can both be used at once. Gamma is applied before the Pixel LUT.

## 4.5 Sharpening - Color Models

The sharpening features control how sharp the image looks.

Sharpening can be enabled (On) or disabled (Off). By default sharpening is disabled. Use [Sharpening Enable](#) to switch on or off.

When sharpening is enabled, the remaining sharpening features take effect. When it is disabled, the image is not sharpened.

Sharpening is applied only to an intensity gradient change that is above a specified threshold. This prevents sharpening from amplifying subtle intensity variances in what are otherwise smooth patches, but allows significant edges to be more pronounced.

The threshold is specified as a fraction of the total intensity range, and ranges from 0 to 0.25. A threshold higher than 25% produces little to no difference than 25%. High thresholds sharpen only areas with significant intensity changes. Low thresholds sharpen more areas.

The sharpening threshold can be controlled manually or automatically.

For manual control, set [Sharpening Auto](#) to Off. Then set a [Sharpening Threshold](#) value to indicate the minimum intensity gradient change to invoke sharpening.

For automatic control, set Sharpening Auto to On. With automatic control, the value of the Sharpening Threshold is set based on the noise level of the camera.

Adjust the sharpening amount with the [Sharpening](#) control. This value controls how much to amplify the edges above the Sharpening threshold. A value of 0 does not apply any sharpening. A negative value smooths the image. A positive value amplifies the edges of the image. You can boost by a maximum of 8x, but smoothing is limited to 1x. The default value is 2.0.

## 4.6 Summary Table

| Name   | Interface    | Access | Visibility | Description  |
|--|--------------|--------|------------|--|
| <a href="#">Gain Selector</a>                          | IEnumeration |        | Beginner   | Selects which gain to control. The All selection is a total amplification across all channels (or taps).   |
| <a href="#">Gain [Gain Selector]</a>                   | IFloat       |        | Beginner   | Controls the amplification of the video signal in dB.  |
| <a href="#">Gain Auto</a>                              | IEnumeration |        | Beginner   | Sets the automatic gain mode. Set to Off for manual control. Set to Once for a single automatic adjustment then return to Off. Set to Continuous for constant adjustment. In automatic modes, the camera adjusts the gain to maximize the dynamic range. |
| <a href="#">Black Level Selector</a>                   | IEnumeration |        | Beginner   | Selects which black level to control. Only All can be set by the user. Analog and Digital are read-only.   |
| <a href="#">Black Level Raw [Black Level Selector]</a> | Integer      |        | Expert     | Controls the offset of the video signal in camera specific units.  |
| <a href="#">Black Level [Black Level Selector]</a>     | IFloat       |        | Beginner   | Controls the offset of the video signal in percent.  |
| <a href="#">Black Level Clamping Enable</a>            | IBoolean     | RW     | Guru       | Enable the black level auto clamping feature which performs dark current compensation. This feature is not supported by rolling shutter sensors.   |
| <a href="#">Balance Ratio Selector</a>                 | IEnumeration |        | Expert     | Selects a balance ratio to configure once a balance ratio control has been selected.   |
| <a href="#">Balance Ratio [Balance Ratio Selector]</a> | IFloat       |        | Expert     | Controls the balance ratio of the selected color relative to green. Used for white balancing.  |
| <a href="#">Balance White Auto</a>                     | IEnumeration | RW     | Expert     | White Balance compensates for color shifts caused by different lighting conditions. It can be automatically or manually controlled. For manual control, set to Off. For automatic control, set to Once or Continuous.                                    |
| <a href="#">Gamma</a>                                  | IFloat       |        | Beginner   | Controls the gamma correction of pixel intensity.  |
| <a href="#">Gamma Enable</a>                           | IBoolean     |        | Beginner   | Enables/disables gamma correction.   |

| Name                                 | Interface | Access | Visibility | Description  |
|--------------------------------------|-----------|--------|------------|--|
| <a href="#">Sharpening Enable</a>    | IBoolean  | RW     | Beginner   | Enables/disables the sharpening feature. Sharpening is disabled by default.  |
| <a href="#">Sharpening Auto</a>      | IBoolean  | RW     | Beginner   | Enables/disables the auto sharpening feature. When enabled, the camera automatically determines the sharpening threshold based on the noise level of the camera.   |
| <a href="#">Sharpening</a>           | IFloat    | RW     | Beginner   | Controls the amount to sharpen a signal. The sharpened amount is proportional to the difference between a pixel and its neighbors. A negative value smooths out the difference, while a positive value amplifies the difference. You can boost by a maximum of 8x, but smoothing is limited to 1x (in float). Default value: 2.0   |
| <a href="#">Sharpening Threshold</a> | IFloat    | RW     | Guru       | Controls the minimum intensity gradient change to invoke sharpening. When "Sharpening Auto" is enabled, this is determined automatically by the device. The threshold is specified as a fraction of the total intensity range, and ranges from 0 to 0.25. A threshold higher than 25% produces little to no difference than 25%. High thresholds sharpen only areas with significant intensity changes. Low thresholds sharpen more areas. |

## 4.7 Analog Control Features

### 4.7.1 Gain Selector

Selects which gain to control. The All selection is a total amplification across all channels (or taps).

| Property          | Value        |
|-------------------|--------------|
| <b>Name</b>       | GainSelector |
| <b>Interface</b>  | IEnumeration |
| <b>Access</b>     |              |
| <b>Visibility</b> | Beginner     |

#### Enumeration Values

All

### 4.7.2 Gain

Controls the amplification of the video signal in dB.

| Property          | Value                                |
|-------------------|--------------------------------------|
| <b>Name</b>       | Gain <a href="#">[Gain Selector]</a> |
| <b>Interface</b>  | IFloat                               |
| <b>Access</b>     |                                      |
| <b>Unit</b>       | dB                                   |
| <b>Visibility</b> | Beginner                             |

### 4.7.3 Gain Auto

Sets the automatic gain mode. Set to Off for manual control. Set to Once for a single automatic adjustment then return to Off. Set to Continuous for constant adjustment. In automatic modes, the camera adjusts the gain to maximize the dynamic range.

| Property          | Value        |
|-------------------|--------------|
| <b>Name</b>       | GainAuto     |
| <b>Interface</b>  | IEnumeration |
| <b>Access</b>     |              |
| <b>Visibility</b> | Beginner     |

#### Enumeration Values

|                   |
|-------------------|
| <b>Off</b>        |
| <b>Once</b>       |
| <b>Continuous</b> |

### 4.7.4 Black Level Selector

Selects which black level to control. Only All can be set by the user. Analog and Digital are read-only.

| Property          | Value              |
|-------------------|--------------------|
| <b>Name</b>       | BlackLevelSelector |
| <b>Interface</b>  | IEnumeration       |
| <b>Access</b>     |                    |
| <b>Visibility</b> | Beginner           |

### Enumeration Values

|         |
|---------|
| All     |
| Analog  |
| Digital |

## 4.7.5 Black Level Raw

Controls the offset of the video signal in camera specific units.

| Property          | Value  |
|-------------------|--|
| <b>Name</b>       | BlackLevelRaw <a href="#">[Black Level Selector]</a> |
| <b>Interface</b>  | Integer  |
| <b>Access</b>     |  |
| <b>Unit</b>       |  |
| <b>Visibility</b> | Expert   |

## 4.7.6 Black Level

Controls the offset of the video signal in percent.

| Property          | Value   |
|-------------------|---|
| <b>Name</b>       | BlackLevel <a href="#">[Black Level Selector]</a> |
| <b>Interface</b>  | IFloat  |
| <b>Access</b>     |   |
| <b>Unit</b>       | %   |
| <b>Visibility</b> | Beginner  |

## 4.7.7 Black Level Clamping Enable

Enable the black level auto clamping feature which performs dark current compensation. This feature is not supported by rolling shutter sensors.

| Property    | Value                    |
|-------------|--------------------------|
| <b>Name</b> | BlackLevelClampingEnable |

| Property          | Value    |
|-------------------|----------|
| <b>Interface</b>  | IBoolean |
| <b>Access</b>     | RW       |
| <b>Visibility</b> | Guru     |

## 4.7.8 Balance Ratio Selector

Selects a balance ratio to configure once a balance ratio control has been selected.

| Property          | Value                |
|-------------------|----------------------|
| <b>Name</b>       | BalanceRatioSelector |
| <b>Interface</b>  | IEnumeration         |
| <b>Access</b>     |                      |
| <b>Visibility</b> | Expert               |

### Enumeration Values

|      |
|------|
| Red  |
| Blue |

## 4.7.9 Balance Ratio

Controls the balance ratio of the selected color relative to green. Used for white balancing.

| Property          | Value   |
|-------------------|---|
| <b>Name</b>       | BalanceRatio <a href="#">[Balance Ratio Selector]</a> |
| <b>Interface</b>  | IFloat  |
| <b>Access</b>     |   |
| <b>Unit</b>       |   |
| <b>Visibility</b> | Expert  |

## 4.7.10 Balance White Auto

White Balance compensates for color shifts caused by different lighting conditions. It can be automatically or manually controlled. For manual control, set to Off. For automatic control, set to Once or Continuous.

| Property          | Value            |
|-------------------|------------------|
| <b>Name</b>       | BalanceWhiteAuto |
| <b>Interface</b>  | IEnumeration     |
| <b>Access</b>     | RW               |
| <b>Visibility</b> | Expert           |

**Enumeration Values**

|            |
|------------|
| Off        |
| Once       |
| Continuous |

### 4.7.11 Gamma

Controls the gamma correction of pixel intensity.

| Property          | Value    |
|-------------------|----------|
| <b>Name</b>       | Gamma    |
| <b>Interface</b>  | IFloat   |
| <b>Access</b>     |          |
| <b>Unit</b>       |          |
| <b>Visibility</b> | Beginner |

### 4.7.12 Gamma Enable

Enables/disables gamma correction.

| Property          | Value       |
|-------------------|-------------|
| <b>Name</b>       | GammaEnable |
| <b>Interface</b>  | IBoolean    |
| <b>Access</b>     |             |
| <b>Visibility</b> | Beginner    |



### 4.7.13 Sharpening Enable

Enables/disables the sharpening feature. Sharpening is disabled by default.

| Property          | Value            |
|-------------------|------------------|
| <b>Name</b>       | SharpeningEnable |
| <b>Interface</b>  | IBoolean         |
| <b>Access</b>     | RW               |
| <b>Visibility</b> | Beginner         |

### 4.7.14 Sharpening Auto

Enables/disables the auto sharpening feature. When enabled, the camera automatically determines the sharpening threshold based on the noise level of the camera.

| Property          | Value          |
|-------------------|----------------|
| <b>Name</b>       | SharpeningAuto |
| <b>Interface</b>  | IBoolean       |
| <b>Access</b>     | RW             |
| <b>Visibility</b> | Beginner       |

### 4.7.15 Sharpening

Controls the amount to sharpen a signal. The sharpened amount is proportional to the difference between a pixel and its neighbors. A negative value smooths out the difference, while a positive value amplifies the difference. You can boost by a maximum of 8x, but smoothing is limited to 1x (in float). Default value: 2.0

| Property          | Value      |
|-------------------|------------|
| <b>Name</b>       | Sharpening |
| <b>Interface</b>  | IFloat     |
| <b>Access</b>     | RW         |
| <b>Unit</b>       |            |
| <b>Visibility</b> | Beginner   |

## 4.7.16 Sharpening Threshold

Controls the minimum intensity gradient change to invoke sharpening. When "Sharpening Auto" is enabled, this is determined automatically by the device. The threshold is specified as a fraction of the total intensity range, and ranges from 0 to 0.25. A threshold higher than 25% produces little to no difference than 25%. High thresholds sharpen only areas with significant intensity changes. Low thresholds sharpen more areas.

| Property          | Value               |
|-------------------|---------------------|
| <b>Name</b>       | SharpeningThreshold |
| <b>Interface</b>  | IFloat              |
| <b>Access</b>     | RW                  |
| <b>Unit</b>       |                     |
| <b>Visibility</b> | Guru                |

# 5 Image Format Control

## 5.1 Region Of Interest

An image region of interest (ROI) lets you specify a portion of the image so that after each image is acquired only the pixel information from the specified portion is processed.

Use the following features to specify the location and size of the ROI. All values are in pixels.

[OffsetX](#) - Horizontal offset from the origin to the ROI.

[Width](#) - Width of the image provided by the device. This reflects the current ROI. The maximum value of this feature takes into account horizontal binning, decimation, or any other function changing the maximum horizontal dimensions of the image and is typically equal to [WidthMax](#) minus OffsetX.

[OffsetY](#) - Vertical offset from the origin to the ROI.

[Height](#) - Height of the image provided by the device. This reflects the current ROI. The maximum value of this feature takes into account vertical binning, decimation, or any other function changing the maximum vertical dimensions of the image and is typically equal to [HeightMax](#) minus OffsetY.

## 5.2 Binning/Decimation

Binning refers to the act of combining the signal from groups of photo-sensitive cells into a larger logical pixel. This is achieved by either adding (additive), averaging (average), or discarding (discard). Binning may be implemented in analog by the sensor or digitally by the Image Signal Processing engine (ISP).

**Note:** Binning and Decimation cannot operate simultaneously. For one to be active, the other must be inactive. Changes to binning features can only be made while the camera is not streaming.

Use the [BinningSelector](#) to choose the binning engine. This affects both horizontal and vertical binning. The choices are:

**All** - the total amount of binning. In this mode, the camera adjusts the sensor/ISP binning to achieve the best image quality with the fastest frame rate.

**Sensor** - the portion of binning implemented in analog by the sensor. Binning done by the sensor usually results in a higher frame rate. Unless otherwise specified, or unsupported, binning is done by the sensor by default.

**ISP** - the portion of binning implemented digitally by the ISP. Unless otherwise specified, binning is done by the ISP if sensor binning is unsupported or compromises image quality.

Use [BinningHorizontalMode](#) and [BinningVerticalMode](#) to choose the algorithm to perform the combination. The choices are:

**Additive** - The response from the combined cells are added, resulting in increased sensitivity (a brighter image).

**Average** - The response from the combined cells are averaged, resulting in increased signal to noise ratio. Some sensors do not support average binning.

Use [BinningHorizontal](#) and [BinningVertical](#) to set the number of cells to combine. Binning values reduce the resolution of the image by a corresponding factor. A value of 1 indicates no binning. This must be set to 1 for decimation to be active.

Use [DecimationSelector](#) to choose the decimation engine. The choices are **All** or **Sensor**. Decimation cannot be done by the ISP.

[DecimationHorizontalMode](#) and [DecimationVerticalMode](#) indicate the algorithm to perform the reduction. There is only one decimation mode supported: **Discard**.

Use [DecimationHorizontal](#) and [DecimationVertical](#) to set the number of cells to discard. This value reduces the resolution of the image by only retaining a single pixel within a window whose size is the specified decimation factor. A value of 1 indicates no decimation. This must be set to 1 for binning to be active.

## 5.2.1 Binning/Decimation Feature Dependency

There are many feature dependencies which can affect binning. You can disable the ISP engine which would force all binning to be sensor controlled. However, some pixel formats (such as YUV and RGB) do not allow the ISP to be disabled, as it is required for color interpolation. In addition, not all sensors support average binning.

A simple hierarchical organization of the features means that features higher up have the greatest flexibility. Choices made at the top of the hierarchy adjust features downstream. The camera always attempts to achieve the best possible image quality.

## 5.3 Pixel Format

Format of the pixel provided by the camera. Use [PixelFormat](#) feature to select from a list of supported formats. (Not all formats are supported on all cameras.) Once a format is selected, the following values are derived:

[PixelFormatSize](#) provides the total size in bits of the image's pixel.

[PixelFormatColorFilter](#) is the type of color filter that is applied to the image. This only applies to bayer formats. The value is None for other formats.

[PixelFormatDynamicRangeMin](#) is the minimum value that can be returned during the digitization process. This corresponds to the darkest value of the camera. For color cameras, this returns the smallest value that each color component can take.

[PixelFormatDynamicRangeMax](#) is the maximum value that can be returned during the digitization process. This corresponds to the brightest value of the camera. For color cameras, this returns the largest value that each color component can take.

**Note:** For color cameras, the bayer pixel format is updated if [Reverse X](#) and [Reverse Y](#) are changed. For example, if the original pixel format is BayerRG8 and [Reverse X](#) is switched from Disabled to Enabled, then the pixel format is updated to BayerGR8.

### 5.3.1 Single Channel 8-bit and 16-bit Formats

|                      |          |                                     |
|----------------------|----------|-------------------------------------|
| <b>8-bit Formats</b> | Mono8    | 8-bit monochrome packed format      |
|                      | BayerGR8 | 8-bit bayer green red packed format |

|                       |           |                                       |
|-----------------------|-----------|---------------------------------------|
|                       | BayerRG8  | 8-bit bayer red green packed format   |
|                       | BayerGB8  | 8-bit bayer green blue packed format  |
|                       | BayerBG8  | 8-bit bayer blue green packed format  |
| <b>16-bit Formats</b> | Mono16    | 16-bit monochrome packed format       |
|                       | BayerGR16 | 16-bit bayer green red packed format  |
|                       | BayerRG16 | 16-bit bayer red green packed format  |
|                       | BayerGB16 | 16-bit bayer green blue packed format |
|                       | BayerBG16 | 16-bit bayer blue green packed format |

### 5.3.2 Single Channel 10-bit Formats

10-bit pixel formats have two different packing formats as defined by USB3 Vision and GigE Vision. **Note:** the packing format is not related to the interface of the camera. Both may be available on USB3 or GigE devices.

The USB3 Vision method is designated with a p. It is a 10-bit format with its bit-stream following the bit packing method illustrated in Figure 1. The first byte of the packed stream contains the eight least significant bits (lsb) of the first pixel. The two lsb of the second byte contain two msb of the first pixel, and the rest of the second byte is packed with the six lsb of the second pixel. The four msb of the second pixels fill into the four lsb of the third byte. The lsb of the third pixel fill in the rest of the third byte, and the remaining bits of the third pixel fill in the lsb of the fourth byte. The bytes are packed following this pattern. In general, pixels are packed into bytes in sequence from lsb, and four pixels pack into five bytes.

This packing format is applied to: Mono10p, BayerGR10p, BayerRG10p, BayerGB10p and BayerBG10p.

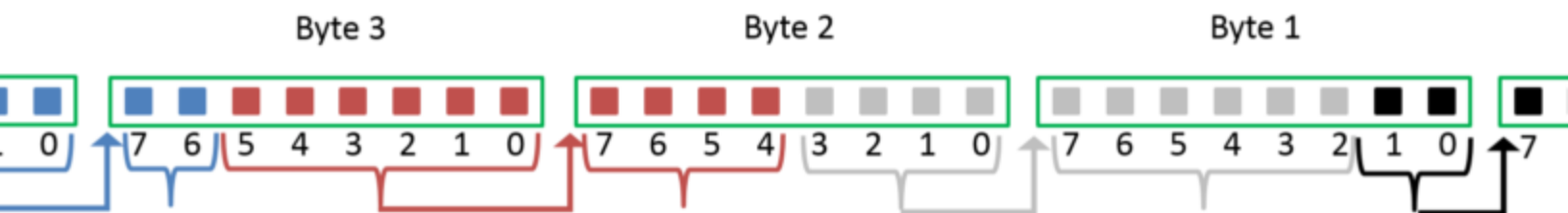

**Figure 1.** Packing two 10-bit pixels into three bytes.

The GigE Vision method is designated with Packed. It is a 10-bit format with its bit-stream following the bit packing method illustrated in Figure 2. The first byte of the packed stream contains the eight msb of the first pixel. The third byte contains the eight msb of the second pixel. The two lsb of the second byte contains two lsb of the first pixel, and the fifth and the sixth bits of the second byte are packed with the two lsb of the second pixel. The remaining bits in the second bytes are set to null.

This packing format is applied to: Mono10Packed, BayerGR10Packed, BayerRG10Packed, BayerGB10Packed and BayerBG10Packed.

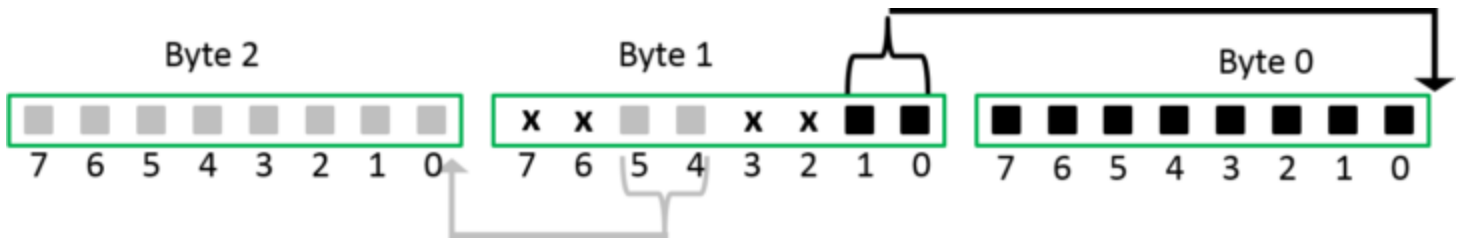

Figure 2. Packing two 10-bit pixels into three bytes.

### 5.3.3 Single Channel 12-bit Formats

12-bit pixel formats have two different packing formats as defined by USB3 Vision and GigE Vision. **Note:** the packing format is not related to the interface of the camera. Both may be available on USB3 or GigE devices.

The USB3 Vision method is designated with a p. It is a 12-bit format with its bit-stream following the bit packing method illustrated in Figure 3. The first byte of the packed stream contains the eight least significant bits (lsb) of the first pixel. The third byte contains the eight most significant bits (msb) of the second pixel. The four lsb of the second byte contains four msb of the first pixel, and the rest of the second byte is packed with the four lsb of the second pixel.

This packing format is applied to: Mono12p, BayerGR12p, BayerRG12p, BayerGB12p and BayerBG12p.

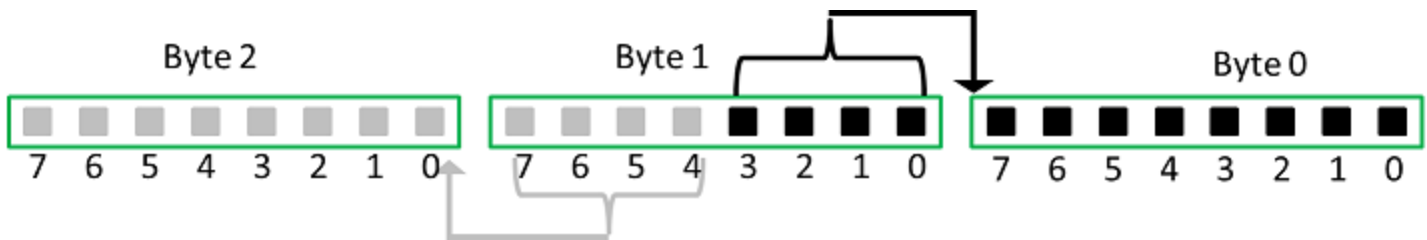

Figure 3. Packing two 12-bit pixels into three bytes.

The GigE Vision method is designated with Packed. It is a 12-bit format with its bit-stream following the bit packing method illustrated in Figure 4. The first byte of the packed stream contains the eight msb of the first pixel. The third byte contains the eight msb of the second pixel. The four lsb of the second byte contains four lsb of the first pixel, and the rest of the second byte is packed with the four lsb of the second pixel.

This packing format is applied to: Mono12Packed, BayerGR12Packed, BayerRG12Packed, BayerGB12Packed and BayerBG12Packed.

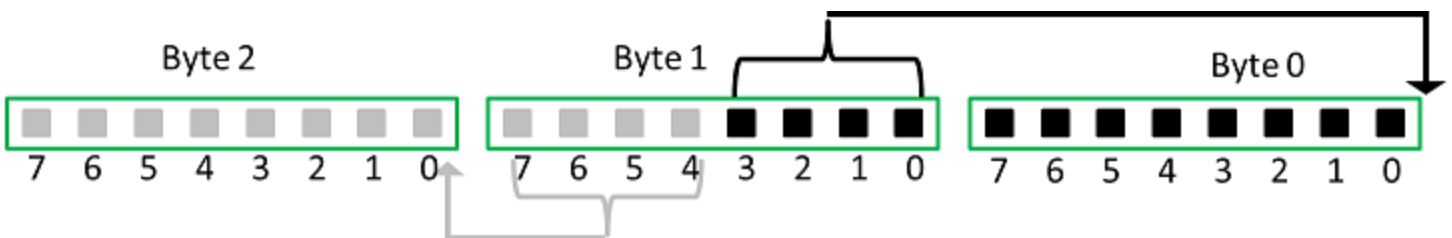

Figure 4. Packing two 12-bit pixels into three bytes.

### 5.3.4 Multi-Channel Formats - Color Models

For the following pixel formats, the color channels are packed in the order indicated:

- RGB8Packed 8-bit red-green-blue packed format
- BGR8 8-bit blue-green-red packed format
- BGRa8 8-bit blue-green-red-alpha packed format

For YCbCr and YUV pixel formats, the RGB to YCbCr transformation follows Equation 1 below:

$$\begin{aligned}
 Y' &= 0.299 R' + 0.587 G' + 0.114 B' \\
 Cb &= -0.16874 R' - 0.33126 G' + 0.5000 B' + 128 \\
 Cr &= 0.5000 R' - 0.41869 G' - 0.08131 B' + 128
 \end{aligned}$$

### 5.3.4.1 YCbCr8 / YUV444Packed

8-bit Y-Cb-Cr 4:4:4 format (Figure 5). No sub-sampling on Y, Cb or Cr. The values of Y, Cb and Cr cover the full range from 0 to 255 if the input R, G and B values are in the range of [0, 255].

|                 |                 |                 |                 |                 |                 |                 |                 |                 |                 |                 |                 |                 |                 |                 |                 |                 |                 |                 |                 |                 |                 |                 |                 |
|-----------------|-----------------|-----------------|-----------------|-----------------|-----------------|-----------------|-----------------|-----------------|-----------------|-----------------|-----------------|-----------------|-----------------|-----------------|-----------------|-----------------|-----------------|-----------------|-----------------|-----------------|-----------------|-----------------|-----------------|
| Y <sub>00</sub> | Y <sub>01</sub> | Y <sub>02</sub> | Y <sub>03</sub> | Y <sub>04</sub> | Y <sub>05</sub> | Y <sub>06</sub> | Y <sub>07</sub> | U <sub>00</sub> | U <sub>01</sub> | U <sub>02</sub> | U <sub>03</sub> | U <sub>04</sub> | U <sub>05</sub> | U <sub>06</sub> | U <sub>07</sub> | V <sub>00</sub> | V <sub>01</sub> | V <sub>02</sub> | V <sub>03</sub> | V <sub>04</sub> | V <sub>05</sub> | V <sub>06</sub> | V <sub>07</sub> |
| Y <sub>10</sub> | Y <sub>11</sub> | Y <sub>12</sub> | Y <sub>13</sub> | Y <sub>14</sub> | Y <sub>15</sub> | Y <sub>16</sub> | Y <sub>17</sub> | U <sub>10</sub> | U <sub>11</sub> | U <sub>12</sub> | U <sub>13</sub> | U <sub>14</sub> | U <sub>15</sub> | U <sub>16</sub> | U <sub>17</sub> | V <sub>10</sub> | V <sub>11</sub> | V <sub>12</sub> | V <sub>13</sub> | V <sub>14</sub> | V <sub>15</sub> | V <sub>16</sub> | V <sub>17</sub> |
| Y <sub>20</sub> | Y <sub>21</sub> | Y <sub>22</sub> | Y <sub>23</sub> | Y <sub>24</sub> | Y <sub>25</sub> | Y <sub>26</sub> | Y <sub>27</sub> | U <sub>20</sub> | U <sub>21</sub> | U <sub>22</sub> | U <sub>23</sub> | U <sub>24</sub> | U <sub>25</sub> | U <sub>26</sub> | U <sub>27</sub> | V <sub>20</sub> | V <sub>21</sub> | V <sub>22</sub> | V <sub>23</sub> | V <sub>24</sub> | V <sub>25</sub> | V <sub>26</sub> | V <sub>27</sub> |
| Y <sub>30</sub> | Y <sub>31</sub> | Y <sub>32</sub> | Y <sub>33</sub> | Y <sub>34</sub> | Y <sub>35</sub> | Y <sub>36</sub> | Y <sub>37</sub> | U <sub>30</sub> | U <sub>31</sub> | U <sub>32</sub> | U <sub>33</sub> | U <sub>34</sub> | U <sub>35</sub> | U <sub>36</sub> | U <sub>37</sub> | V <sub>30</sub> | V <sub>31</sub> | V <sub>32</sub> | V <sub>33</sub> | V <sub>34</sub> | V <sub>35</sub> | V <sub>36</sub> | V <sub>37</sub> |
| Y <sub>40</sub> | Y <sub>41</sub> | Y <sub>42</sub> | Y <sub>43</sub> | Y <sub>44</sub> | Y <sub>45</sub> | Y <sub>46</sub> | Y <sub>47</sub> | U <sub>40</sub> | U <sub>41</sub> | U <sub>42</sub> | U <sub>43</sub> | U <sub>44</sub> | U <sub>45</sub> | U <sub>46</sub> | U <sub>47</sub> | V <sub>40</sub> | V <sub>41</sub> | V <sub>42</sub> | V <sub>43</sub> | V <sub>44</sub> | V <sub>45</sub> | V <sub>46</sub> | V <sub>47</sub> |

Figure 5. Y-Cb-Cr 4:4:4 format.

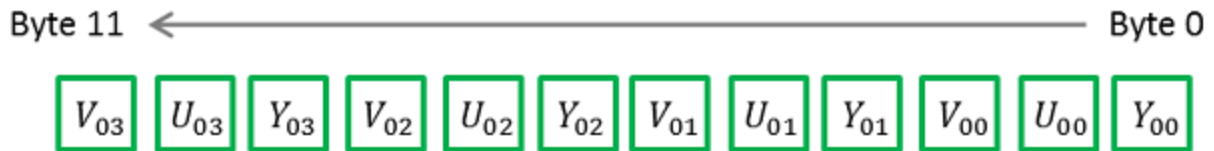

Figure 6. Packing format for YCbCr8.

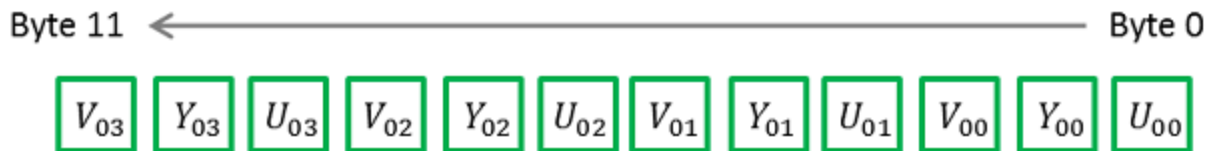

Figure 7. Packing format for YUV444Packed.

### 5.3.4.2 YCbCr422\_8 / YUV422Packed

8-bit Y-Cb-Cr 4:2:2 format (Figure 8). No sub-sampling on Y. Cb and Cr are sub-sampled by a factor of 2 in the horizontal direction, but no sub-sampling in the vertical direction. The values of Y, Cb and Cr cover the full range from 0 to 255 if the input R, G and B values are in the range of [0, 255].

|                 |                 |                 |                 |                 |                 |                 |                 |                 |                 |                 |                 |                 |                 |                 |                 |                 |                 |                 |                 |                 |                 |                 |                 |
|-----------------|-----------------|-----------------|-----------------|-----------------|-----------------|-----------------|-----------------|-----------------|-----------------|-----------------|-----------------|-----------------|-----------------|-----------------|-----------------|-----------------|-----------------|-----------------|-----------------|-----------------|-----------------|-----------------|-----------------|
| Y <sub>00</sub> | Y <sub>01</sub> | Y <sub>02</sub> | Y <sub>03</sub> | Y <sub>04</sub> | Y <sub>05</sub> | Y <sub>06</sub> | Y <sub>07</sub> | U <sub>00</sub> | U <sub>01</sub> | U <sub>02</sub> | U <sub>03</sub> | U <sub>04</sub> | U <sub>05</sub> | U <sub>06</sub> | U <sub>07</sub> | V <sub>00</sub> | V <sub>01</sub> | V <sub>02</sub> | V <sub>03</sub> | V <sub>04</sub> | V <sub>05</sub> | V <sub>06</sub> | V <sub>07</sub> |
| Y <sub>10</sub> | Y <sub>11</sub> | Y <sub>12</sub> | Y <sub>13</sub> | Y <sub>14</sub> | Y <sub>15</sub> | Y <sub>16</sub> | Y <sub>17</sub> | U <sub>10</sub> | U <sub>11</sub> | U <sub>12</sub> | U <sub>13</sub> | U <sub>14</sub> | U <sub>15</sub> | U <sub>16</sub> | U <sub>17</sub> | V <sub>10</sub> | V <sub>11</sub> | V <sub>12</sub> | V <sub>13</sub> | V <sub>14</sub> | V <sub>15</sub> | V <sub>16</sub> | V <sub>17</sub> |
| Y <sub>20</sub> | Y <sub>21</sub> | Y <sub>22</sub> | Y <sub>23</sub> | Y <sub>24</sub> | Y <sub>25</sub> | Y <sub>26</sub> | Y <sub>27</sub> | U <sub>20</sub> | U <sub>21</sub> | U <sub>22</sub> | U <sub>23</sub> | U <sub>24</sub> | U <sub>25</sub> | U <sub>26</sub> | U <sub>27</sub> | V <sub>20</sub> | V <sub>21</sub> | V <sub>22</sub> | V <sub>23</sub> | V <sub>24</sub> | V <sub>25</sub> | V <sub>26</sub> | V <sub>27</sub> |
| Y <sub>30</sub> | Y <sub>31</sub> | Y <sub>32</sub> | Y <sub>33</sub> | Y <sub>34</sub> | Y <sub>35</sub> | Y <sub>36</sub> | Y <sub>37</sub> | U <sub>30</sub> | U <sub>31</sub> | U <sub>32</sub> | U <sub>33</sub> | U <sub>34</sub> | U <sub>35</sub> | U <sub>36</sub> | U <sub>37</sub> | V <sub>30</sub> | V <sub>31</sub> | V <sub>32</sub> | V <sub>33</sub> | V <sub>34</sub> | V <sub>35</sub> | V <sub>36</sub> | V <sub>37</sub> |
| Y <sub>40</sub> | Y <sub>41</sub> | Y <sub>42</sub> | Y <sub>43</sub> | Y <sub>44</sub> | Y <sub>45</sub> | Y <sub>46</sub> | Y <sub>47</sub> | U <sub>40</sub> | U <sub>41</sub> | U <sub>42</sub> | U <sub>43</sub> | U <sub>44</sub> | U <sub>45</sub> | U <sub>46</sub> | U <sub>47</sub> | V <sub>40</sub> | V <sub>41</sub> | V <sub>42</sub> | V <sub>43</sub> | V <sub>44</sub> | V <sub>45</sub> | V <sub>46</sub> | V <sub>47</sub> |

Figure 8. Y-Cb-Cr 4:2:2 format.

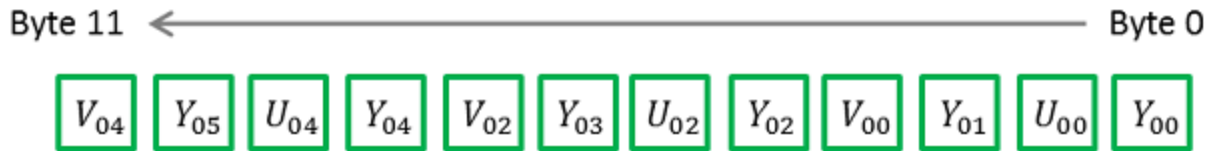

Figure 9. Packing format for YCbCr422\_8.

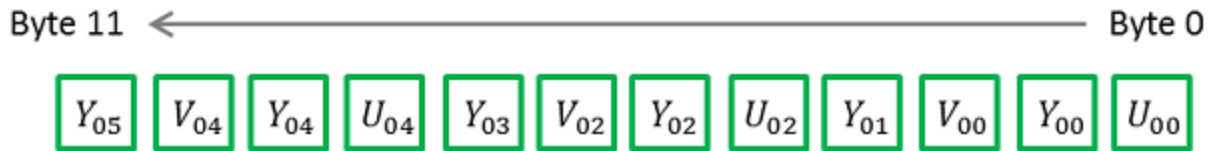

Figure 10. Packing format for YUV422Packed.

### 5.3.4.3 YCbCr411\_8 / YUV411Packed

8-bit Y-Cb-Cr 4:1:1 format (Figure 11). No sub-sampling on Y. Cb and Cr are sub-sampled by a factor of 4 in the horizontal direction, but no sub-sampling in the vertical direction. The values of Y, Cb and Cr cover the full range from 0 to 255 if the input R, G and B values are in the range of [0, 255].

|                 |                 |                 |                 |                 |                 |                 |                 |                 |                 |                 |                 |                 |                 |                 |                 |                 |                 |                 |                 |                 |                 |                 |                 |
|-----------------|-----------------|-----------------|-----------------|-----------------|-----------------|-----------------|-----------------|-----------------|-----------------|-----------------|-----------------|-----------------|-----------------|-----------------|-----------------|-----------------|-----------------|-----------------|-----------------|-----------------|-----------------|-----------------|-----------------|
| Y <sub>00</sub> | Y <sub>01</sub> | Y <sub>02</sub> | Y <sub>03</sub> | Y <sub>04</sub> | Y <sub>05</sub> | Y <sub>06</sub> | Y <sub>07</sub> | U <sub>00</sub> | U <sub>01</sub> | U <sub>02</sub> | U <sub>03</sub> | U <sub>04</sub> | U <sub>05</sub> | U <sub>06</sub> | U <sub>07</sub> | V <sub>00</sub> | V <sub>01</sub> | V <sub>02</sub> | V <sub>03</sub> | V <sub>04</sub> | V <sub>05</sub> | V <sub>06</sub> | V <sub>07</sub> |
| Y <sub>10</sub> | Y <sub>11</sub> | Y <sub>12</sub> | Y <sub>13</sub> | Y <sub>14</sub> | Y <sub>15</sub> | Y <sub>16</sub> | Y <sub>17</sub> | U <sub>10</sub> | U <sub>11</sub> | U <sub>12</sub> | U <sub>13</sub> | U <sub>14</sub> | U <sub>15</sub> | U <sub>16</sub> | U <sub>17</sub> | V <sub>10</sub> | V <sub>11</sub> | V <sub>12</sub> | V <sub>13</sub> | V <sub>14</sub> | V <sub>15</sub> | V <sub>16</sub> | V <sub>17</sub> |
| Y <sub>20</sub> | Y <sub>21</sub> | Y <sub>22</sub> | Y <sub>23</sub> | Y <sub>24</sub> | Y <sub>25</sub> | Y <sub>26</sub> | Y <sub>27</sub> | U <sub>20</sub> | U <sub>21</sub> | U <sub>22</sub> | U <sub>23</sub> | U <sub>24</sub> | U <sub>25</sub> | U <sub>26</sub> | U <sub>27</sub> | V <sub>20</sub> | V <sub>21</sub> | V <sub>22</sub> | V <sub>23</sub> | V <sub>24</sub> | V <sub>25</sub> | V <sub>26</sub> | V <sub>27</sub> |
| Y <sub>30</sub> | Y <sub>31</sub> | Y <sub>32</sub> | Y <sub>33</sub> | Y <sub>34</sub> | Y <sub>35</sub> | Y <sub>36</sub> | Y <sub>37</sub> | U <sub>30</sub> | U <sub>31</sub> | U <sub>32</sub> | U <sub>33</sub> | U <sub>34</sub> | U <sub>35</sub> | U <sub>36</sub> | U <sub>37</sub> | V <sub>30</sub> | V <sub>31</sub> | V <sub>32</sub> | V <sub>33</sub> | V <sub>34</sub> | V <sub>35</sub> | V <sub>36</sub> | V <sub>37</sub> |
| Y <sub>40</sub> | Y <sub>41</sub> | Y <sub>42</sub> | Y <sub>43</sub> | Y <sub>44</sub> | Y <sub>45</sub> | Y <sub>46</sub> | Y <sub>47</sub> | U <sub>40</sub> | U <sub>41</sub> | U <sub>42</sub> | U <sub>43</sub> | U <sub>44</sub> | U <sub>45</sub> | U <sub>46</sub> | U <sub>47</sub> | V <sub>40</sub> | V <sub>41</sub> | V <sub>42</sub> | V <sub>43</sub> | V <sub>44</sub> | V <sub>45</sub> | V <sub>46</sub> | V <sub>47</sub> |

Figure 11. Y-Cb-Cr 4:1:1 format.

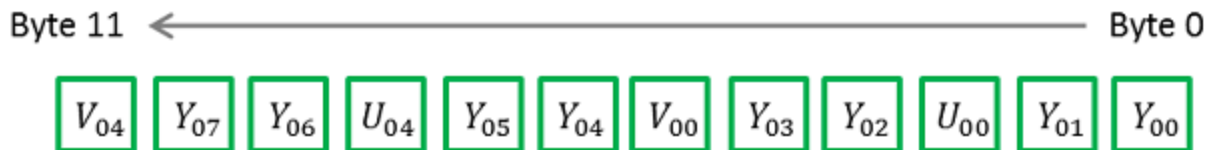

Figure 12. Packing format for YCbCr411\_8.



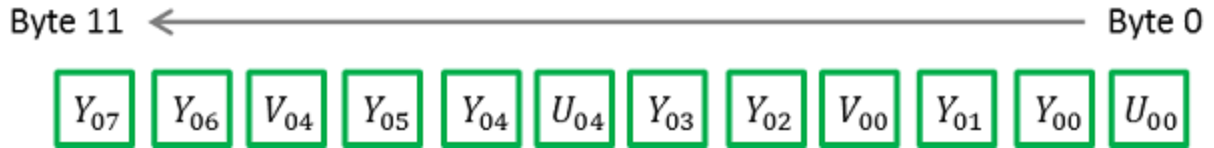

Figure 13. Packing format for YUV411Packed.

## 5.4 ADC Bit Depth

All camera sensors incorporate an analog to digital converter (ADC) to digitize the images.

The camera's ADC is configured to a fixed bit output. This is not the same as pixel size. If the pixel format selected has fewer bits per pixel than the ADC output, the least significant bits are dropped. If the pixel format selected has greater bits per pixel than the ADC output, the least significant bits are padded and can be discarded by the user. Image data is left-aligned across a 2-byte format.

For example, for a 12-bit output, the least significant 4 bits are padded in order to fill 2 bytes (0xFF0).

A 10-bit conversion produces 1,024 possible values between 0 and 65,472.

A 12-bit conversion produces 4,096 possible values between 0 and 65,520.

A 14-bit conversion produces 16,384 possible values between 0 and 65,532.

Some image sensors support multiple ADC bit depths. A higher ADC bit depth results in better image quality but slower maximum frame rate. Stop acquisition then use the [ADC Bit Depth](#) control to make a selection.

## 5.5 Test Pattern

The camera is capable of outputting continuous static images for testing and development purposes.

Use the [TestPatternGeneratorSelector](#) feature to choose which test pattern to control.

**Sensor** produces a test pattern that varies based on the image sensor.

**Pipeline Start** inserts a test pattern at the start of the camera's image processing pipeline.

Set the [TestPattern](#) feature to Off to disable the selected test pattern generator.

When Sensor is selected, create a test pattern by setting the [TestPattern](#) feature to Sensor Test Pattern.

When Pipeline Start is selected, create a test pattern by setting the [TestPattern](#) feature to Increment or Variable Frame Sequence. The Increment test pattern increases the pixel value by one 8-bit greyscale value at each pixel location, wrapping around to zero after it reaches 255.

The Variable Frame Sequence option generates a sequence of frames containing varying test pattern. The sequence resets at the start of acquisition.

Both test pattern generators can be enabled at the same time, however, the Pipeline Start test pattern overwrites the Sensor test pattern.

Most image processing features (such as [Gamma](#), [Balance Ratio](#), and others) are still available when the test pattern is on and can alter the test pattern image. Some features for controlling the sensor do not affect the test pattern image, such

as [Exposure Time](#), [Gain](#), and analog [Black Level](#). It is recommended to turn [Exposure Auto](#) and [Gain Auto](#) Off when using a test pattern, as those features do not function properly when the test pattern is on.

Note that the test pattern generators must be set to Off to get the actual image data from the sensor.

## 5.6 Reverse X

When Reverse X is enabled, it horizontally flips the image sent by the camera. The region of interest is applied after flipping.

For color cameras, the bayer pixel format may be changed after flipping. For example, BayerRG16 is changed to BayerGR16.

## 5.7 Reverse Y

When Reverse Y is enabled, it vertically flips the image sent by the camera. The region of interest is applied after flipping.

For color cameras, the bayer pixel format may be changed after flipping. For example, BayerRG16 is changed to BayerGB16.

## 5.8 Summary Table

| Name                          | Interface   | Access | Visibility | Description  |
|-------------------------------|-------------|--------|------------|--|
| <a href="#">Sensor Width</a>  | Integer     | RO     | Expert     | Effective width of the sensor in pixels.   |
| <a href="#">Sensor Height</a> | Integer     | RO     | Expert     | Effective height of the sensor in pixels.  |
| <a href="#">Width Max</a>     | Integer     |        | Expert     | Maximum width of the image (in pixels). The dimension is calculated after horizontal binning. WidthMax does not take into account the current Region of interest (Width or OffsetX).   |
| <a href="#">Height Max</a>    | Integer     |        | Expert     | Maximum height of the image (in pixels). This dimension is calculated after vertical binning. HeightMax does not take into account the current Region of interest (Height or OffsetY). |
| <a href="#">Width</a>         | Integer     |        | Beginner   | Width of the image provided by the device (in pixels).   |
| <a href="#">Height</a>        | Integer     |        | Beginner   | Height of the image provided by the device (in pixels).  |
| <a href="#">Offset X</a>      | Integer     |        | Beginner   | Horizontal offset from the origin to the ROI (in pixels).  |
| <a href="#">Offset Y</a>      | Integer     |        | Beginner   | Vertical offset from the origin to the ROI (in pixels).  |
| <a href="#">Pixel Format</a>  | Enumeration |        | Beginner   | Format of the pixel provided by the camera.  |
| <a href="#">Pixel Size</a>    | Enumeration | RO     | Expert     | Total size in bits of a pixel of the image.  |

| Name   | Interface    | Access | Visibility | Description  |
|--|--------------|--------|------------|--|
| <a href="#">Pixel Color Filter</a>                               | IEnumeration | RO     | Expert     | Type of color filter that is applied to the image. Only applies to Bayer pixel formats. All others have no color filter.   |
| <a href="#">Pixel Dynamic Range Min</a>                          | Integer      | RO     | Expert     | Minimum value that can be returned during the digitization process. This corresponds to the darkest value of the camera. For color cameras, this returns the smallest value that each color component can take.  |
| <a href="#">Pixel Dynamic Range Max</a>                          | Integer      | RO     | Expert     | Maximum value that can be returned during the digitization process. This corresponds to the brightest value of the camera. For color cameras, this returns the biggest value that each color component can take.   |
| <a href="#">ISP Enable</a>                                       | Boolean      | RW     | Expert     | Controls whether the image processing core is used for optional pixel format mode (i.e. mono).   |
| <a href="#">Binning Selector</a>                                 | IEnumeration |        | Beginner   | Selects which binning engine is controlled by the BinningHorizontal and BinningVertical features.  |
| <a href="#">Binning Horizontal Mode [Binning Selector]</a>       | IEnumeration |        | Expert     |  |
| <a href="#">Binning Vertical Mode [Binning Selector]</a>         | IEnumeration |        | Expert     |  |
| <a href="#">Binning Horizontal [Binning Selector]</a>            | Integer      |        | Beginner   | Number of horizontal photo-sensitive cells to combine together. This reduces the horizontal resolution (width) of the image. A value of 1 indicates that no horizontal binning is performed by the camera. This value must be 1 for decimation to be active. |
| <a href="#">Binning Vertical [Binning Selector]</a>              | Integer      |        | Beginner   | Number of vertical photo-sensitive cells to combine together. This reduces the vertical resolution (height) of the image. A value of 1 indicates that no vertical binning is performed by the camera. This value must be 1 for decimation to be active.      |
| <a href="#">Decimation Selector</a>                              | IEnumeration |        | Beginner   | Selects which decimation layer is controlled by the DecimationHorizontal and DecimationVertical features.  |
| <a href="#">Decimation Horizontal Mode [Decimation Selector]</a> | IEnumeration |        | Expert     | The mode used to reduce the horizontal resolution when DecimationHorizontal is used. The current implementation only supports a single decimation mode: Discard. Average should be achieved via Binning.   |

| Name   | Interface    | Access | Visibility | Description  |
|--|--------------|--------|------------|--|
| <a href="#">Decimation Vertical Mode [Decimation Selector]</a> | IEnumeration |        | Expert     | The mode used to reduce the vertical resolution when DecimationVertical is used. The current implementation only supports a single decimation mode: Discard. Average should be achieved via Binning.   |
| <a href="#">Decimation Horizontal [Decimation Selector]</a>    | IInteger     |        | Beginner   | Horizontal decimation of the image. This reduces the horizontal resolution (width) of the image by only retaining a single pixel within a window whose size is the decimation factor specified here. A value of 1 indicates that no horizontal decimation is performed by the camera. This value must be 1 for binning to be active. |
| <a href="#">Decimation Vertical [Decimation Selector]</a>      | IInteger     |        | Beginner   | Vertical decimation of the image. This reduces the vertical resolution (height) of the image by only retaining a single pixel within a window whose size is the decimation factor specified here. A value of 1 indicates that no vertical decimation is performed by the camera. This value must be 1 for binning to be active.      |
| <a href="#">Reverse X</a>                                      | IBoolean     | RW     | Expert     | Horizontally flips the image sent by the device. The region of interest is applied after flipping. For color cameras the bayer pixel format is affected. For example, BayerRG16 changes to BayerGR16.  |
| <a href="#">Reverse Y</a>                                      | IBoolean     | RW     | Expert     | Vertically flips the image sent by the device. The region of interest is applied after flipping. For color cameras the bayer pixel format is affected. For example, BayerRG16 changes to BayerGB16.  |
| <a href="#">Test Pattern Generator Selector</a>                | IEnumeration |        |            | Selects which test pattern generator is controlled by the TestPattern feature.   |
| <a href="#">Test Pattern [Test Pattern Generator Selector]</a> | IEnumeration |        |            | Selects the type of test pattern that is generated by the device as image source.  |
| <a href="#">ADC Bit Depth</a>                                  | IEnumeration |        | Beginner   | Selects which ADC bit depth to use. A higher ADC bit depth results in better image quality but slower maximum frame rate.  |

## 5.9 Image Format Control Features

## 5.9.1 Sensor Width

Effective width of the sensor in pixels.

| Property          | Value       |
|-------------------|-------------|
| <b>Name</b>       | SensorWidth |
| <b>Interface</b>  | Integer     |
| <b>Access</b>     | RO          |
| <b>Unit</b>       |             |
| <b>Visibility</b> | Expert      |
| <b>Value</b>      | 2064        |

## 5.9.2 Sensor Height

Effective height of the sensor in pixels.

| Property          | Value        |
|-------------------|--------------|
| <b>Name</b>       | SensorHeight |
| <b>Interface</b>  | Integer      |
| <b>Access</b>     | RO           |
| <b>Unit</b>       |              |
| <b>Visibility</b> | Expert       |
| <b>Value</b>      | 1544         |

## 5.9.3 Width Max

Maximum width of the image (in pixels). The dimension is calculated after horizontal binning. WidthMax does not take into account the current Region of interest (Width or OffsetX).

| Property         | Value    |
|------------------|----------|
| <b>Name</b>      | WidthMax |
| <b>Interface</b> | Integer  |
| <b>Access</b>    |          |
| <b>Unit</b>      |          |

| Property   | Value  |
|------------|--------|
| Visibility | Expert |

## 5.9.4 Height Max

Maximum height of the image (in pixels). This dimension is calculated after vertical binning. HeightMax does not take into account the current Region of interest (Height or OffsetY).

| Property   | Value     |
|------------|-----------|
| Name       | HeightMax |
| Interface  | Integer   |
| Access     |           |
| Unit       |           |
| Visibility | Expert    |

## 5.9.5 Width

Width of the image provided by the device (in pixels).

| Property   | Value    |
|------------|----------|
| Name       | Width    |
| Interface  | Integer  |
| Access     |          |
| Unit       |          |
| Visibility | Beginner |

## 5.9.6 Height

Height of the image provided by the device (in pixels).

| Property  | Value   |
|-----------|---------|
| Name      | Height  |
| Interface | Integer |
| Access    |         |

| Property   | Value    |
|------------|----------|
| Unit       |          |
| Visibility | Beginner |

## 5.9.7 Offset X

Horizontal offset from the origin to the ROI (in pixels).

| Property   | Value    |
|------------|----------|
| Name       | OffsetX  |
| Interface  | Integer  |
| Access     |          |
| Unit       |          |
| Visibility | Beginner |

## 5.9.8 Offset Y

Vertical offset from the origin to the ROI (in pixels).

| Property   | Value    |
|------------|----------|
| Name       | OffsetY  |
| Interface  | Integer  |
| Access     |          |
| Unit       |          |
| Visibility | Beginner |

## 5.9.9 Pixel Format

Format of the pixel provided by the camera.

| Property  | Value       |
|-----------|-------------|
| Name      | PixelFormat |
| Interface | Enumeration |

| Property | Value |
|----------|-------|
|----------|-------|

|                   |          |
|-------------------|----------|
| <b>Access</b>     |          |
| <b>Visibility</b> | Beginner |

### Enumeration Values

|                        |
|------------------------|
| <b>Mono8</b>           |
| <b>Mono16</b>          |
| <b>RGB8Packed</b>      |
| <b>BayerGR8</b>        |
| <b>BayerRG8</b>        |
| <b>BayerGB8</b>        |
| <b>BayerBG8</b>        |
| <b>BayerGR16</b>       |
| <b>BayerRG16</b>       |
| <b>BayerGB16</b>       |
| <b>BayerBG16</b>       |
| <b>Mono10Packed</b>    |
| <b>BayerGR10Packed</b> |
| <b>BayerRG10Packed</b> |
| <b>BayerGB10Packed</b> |
| <b>BayerBG10Packed</b> |
| <b>Mono12Packed</b>    |
| <b>BayerGR12Packed</b> |
| <b>BayerRG12Packed</b> |
| <b>BayerGB12Packed</b> |
| <b>BayerBG12Packed</b> |
| <b>YUV411Packed</b>    |



### Enumeration Values

|              |
|--------------|
| YUV422Packed |
| YUV444Packed |
| Mono10p      |
| BayerGR10p   |
| BayerRG10p   |
| BayerGB10p   |
| BayerBG10p   |
| Mono12p      |
| BayerGR12p   |
| BayerRG12p   |
| BayerGB12p   |
| BayerBG12p   |
| YCbCr8       |
| YCbCr422_8   |
| YCbCr411_8   |
| BGR8         |
| BGRa8        |

## 5.9.10 Pixel Size

Total size in bits of a pixel of the image.

| Property | Value |
|----------|-------|
|----------|-------|

|                   |              |
|-------------------|--------------|
| <b>Name</b>       | PixelSize    |
| <b>Interface</b>  | IEnumeration |
| <b>Access</b>     | RO           |
| <b>Visibility</b> | Expert       |

### Enumeration Values

|       |
|-------|
| Bpp1  |
| Bpp2  |
| Bpp4  |
| Bpp8  |
| Bpp10 |
| Bpp12 |
| Bpp14 |
| Bpp16 |
| Bpp20 |
| Bpp24 |
| Bpp30 |
| Bpp32 |
| Bpp36 |
| Bpp48 |
| Bpp64 |
| Bpp96 |

## 5.9.11 Pixel Color Filter

Type of color filter that is applied to the image. Only applies to Bayer pixel formats. All others have no color filter.

| Property | Value |
|----------|-------|
|----------|-------|

|                   |                  |
|-------------------|------------------|
| <b>Name</b>       | PixelColorFilter |
| <b>Interface</b>  | IEnumeration     |
| <b>Access</b>     | RO               |
| <b>Visibility</b> | Expert           |

### Enumeration Values

|         |
|---------|
| None    |
| BayerRG |
| BayerGB |
| BayerGR |
| BayerBG |

## 5.9.12 Pixel Dynamic Range Min

Minimum value that can be returned during the digitization process. This corresponds to the darkest value of the camera. For color cameras, this returns the smallest value that each color component can take.

| Property          | Value                |
|-------------------|----------------------|
| <b>Name</b>       | PixelDynamicRangeMin |
| <b>Interface</b>  | Integer              |
| <b>Access</b>     | RO                   |
| <b>Unit</b>       |                      |
| <b>Visibility</b> | Expert               |
| <b>Value</b>      | 0                    |

## 5.9.13 Pixel Dynamic Range Max

Maximum value that can be returned during the digitization process. This corresponds to the brightest value of the camera. For color cameras, this returns the biggest value that each color component can take.

| Property          | Value                |
|-------------------|----------------------|
| <b>Name</b>       | PixelDynamicRangeMax |
| <b>Interface</b>  | Integer              |
| <b>Access</b>     | RO                   |
| <b>Unit</b>       |                      |
| <b>Visibility</b> | Expert               |

### 5.9.14 ISP Enable

Controls whether the image processing core is used for optional pixel format mode (i.e. mono).

| Property          | Value     |
|-------------------|-----------|
| <b>Name</b>       | IspEnable |
| <b>Interface</b>  | IBoolean  |
| <b>Access</b>     | RW        |
| <b>Visibility</b> | Expert    |

### 5.9.15 Binning Selector

Selects which binning engine is controlled by the BinningHorizontal and BinningVertical features.

| Property          | Value           |
|-------------------|-----------------|
| <b>Name</b>       | BinningSelector |
| <b>Interface</b>  | IEnumeration    |
| <b>Access</b>     |                 |
| <b>Visibility</b> | Beginner        |

#### Enumeration Values

|        |
|--------|
| All    |
| Sensor |
| ISP    |

### 5.9.16 Binning Horizontal Mode

| Property          | Value  |
|-------------------|--|
| <b>Name</b>       | BinningHorizontalMode <a href="#">[Binning Selector]</a> |
| <b>Interface</b>  | IEnumeration   |
| <b>Access</b>     |  |
| <b>Visibility</b> | Expert   |

#### Enumeration Values

Sum

Average

### 5.9.17 Binning Vertical Mode

| Property          | Value  |
|-------------------|--|
| <b>Name</b>       | BinningVerticalMode <a href="#">[Binning Selector]</a> |
| <b>Interface</b>  | IEnumeration   |
| <b>Access</b>     |  |
| <b>Visibility</b> | Expert   |

#### Enumeration Values

Sum

Average

### 5.9.18 Binning Horizontal

Number of horizontal photo-sensitive cells to combine together. This reduces the horizontal resolution (width) of the image. A value of 1 indicates that no horizontal binning is performed by the camera. This value must be 1 for decimation to be active.

| Property          | Value  |
|-------------------|--|
| <b>Name</b>       | BinningHorizontal <a href="#">[Binning Selector]</a> |
| <b>Interface</b>  | IInteger   |
| <b>Access</b>     |  |
| <b>Unit</b>       |  |
| <b>Visibility</b> | Beginner   |

### 5.9.19 Binning Vertical

Number of vertical photo-sensitive cells to combine together. This reduces the vertical resolution (height) of the image. A value of 1 indicates that no vertical binning is performed by the camera. This value must be 1 for decimation to be active.

| Property          | Value  |
|-------------------|--|
| <b>Name</b>       | BinningVertical <a href="#">[Binning Selector]</a> |
| <b>Interface</b>  | Integer  |
| <b>Access</b>     |  |
| <b>Unit</b>       |  |
| <b>Visibility</b> | Beginner   |

## 5.9.20 Decimation Selector

Selects which decimation layer is controlled by the DecimationHorizontal and DecimationVertical features.

| Property          | Value              |
|-------------------|--------------------|
| <b>Name</b>       | DecimationSelector |
| <b>Interface</b>  | IEnumeration       |
| <b>Access</b>     |                    |
| <b>Visibility</b> | Beginner           |

### Enumeration Values

|        |
|--------|
| All    |
| Sensor |

## 5.9.21 Decimation Horizontal Mode

The mode used to reduce the horizontal resolution when DecimationHorizontal is used. The current implementation only supports a single decimation mode: Discard. Average should be achieved via Binning.

| Property          | Value  |
|-------------------|--|
| <b>Name</b>       | DecimationHorizontalMode <a href="#">[Decimation Selector]</a> |
| <b>Interface</b>  | IEnumeration   |
| <b>Access</b>     |  |
| <b>Visibility</b> | Expert   |

### Enumeration Values

Discard

## 5.9.22 Decimation Vertical Mode

The mode used to reduce the vertical resolution when DecimationVertical is used. The current implementation only supports a single decimation mode: Discard. Average should be achieved via Binning.

| Property          | Value  |
|-------------------|--|
| <b>Name</b>       | DecimationVerticalMode <a href="#">[Decimation Selector]</a> |
| <b>Interface</b>  | IEnumeration   |
| <b>Access</b>     |  |
| <b>Visibility</b> | Expert   |

### Enumeration Values

Discard

## 5.9.23 Decimation Horizontal

Horizontal decimation of the image. This reduces the horizontal resolution (width) of the image by only retaining a single pixel within a window whose size is the decimation factor specified here. A value of 1 indicates that no horizontal decimation is performed by the camera. This value must be 1 for binning to be active.

| Property          | Value  |
|-------------------|--|
| <b>Name</b>       | DecimationHorizontal <a href="#">[Decimation Selector]</a> |
| <b>Interface</b>  | IInteger   |
| <b>Access</b>     |  |
| <b>Unit</b>       |  |
| <b>Visibility</b> | Beginner   |

## 5.9.24 Decimation Vertical

Vertical decimation of the image. This reduces the vertical resolution (height) of the image by only retaining a single pixel within a window whose size is the decimation factor specified here. A value of 1 indicates that no vertical decimation is performed by the camera. This value must be 1 for binning to be active.

| Property          | Value  |
|-------------------|--|
| <b>Name</b>       | DecimationVertical <a href="#">[Decimation Selector]</a> |
| <b>Interface</b>  | IInteger   |
| <b>Access</b>     |  |
| <b>Unit</b>       |  |
| <b>Visibility</b> | Beginner   |

### 5.9.25 Reverse X

Horizontally flips the image sent by the device. The region of interest is applied after flipping. For color cameras the bayer pixel format is affected. For example, BayerRG16 changes to BayerGR16.

| Property          | Value    |
|-------------------|----------|
| <b>Name</b>       | ReverseX |
| <b>Interface</b>  | IBoolean |
| <b>Access</b>     | RW       |
| <b>Visibility</b> | Expert   |

### 5.9.26 Reverse Y

Vertically flips the image sent by the device. The region of interest is applied after flipping. For color cameras the bayer pixel format is affected. For example, BayerRG16 changes to BayerGB16.

| Property          | Value    |
|-------------------|----------|
| <b>Name</b>       | ReverseY |
| <b>Interface</b>  | IBoolean |
| <b>Access</b>     | RW       |
| <b>Visibility</b> | Expert   |

### 5.9.27 Test Pattern Generator Selector

Selects which test pattern generator is controlled by the TestPattern feature.



| Property          | Value                        |
|-------------------|------------------------------|
| <b>Name</b>       | TestPatternGeneratorSelector |
| <b>Interface</b>  | IEnumeration                 |
| <b>Access</b>     |                              |
| <b>Visibility</b> |                              |

#### Enumeration Values

|               |
|---------------|
| Sensor        |
| PipelineStart |

## 5.9.28 Test Pattern

Selects the type of test pattern that is generated by the device as image source.

| Property          | Value   |
|-------------------|---|
| <b>Name</b>       | TestPattern <a href="#">[Test Pattern Generator Selector]</a> |
| <b>Interface</b>  | IEnumeration  |
| <b>Access</b>     |   |
| <b>Visibility</b> |   |

#### Enumeration Values

|                   |
|-------------------|
| Off               |
| Increment         |
| SensorTestPattern |

## 5.9.29 ADC Bit Depth

Selects which ADC bit depth to use. A higher ADC bit depth results in better image quality but slower maximum frame rate.

| Property    | Value       |
|-------------|-------------|
| <b>Name</b> | AdcBitDepth |

| Property          | Value        |
|-------------------|--------------|
| <b>Interface</b>  | IEnumeration |
| <b>Access</b>     |              |
| <b>Visibility</b> | Beginner     |

#### Enumeration Values

|              |
|--------------|
| <b>Bit8</b>  |
| <b>Bit10</b> |
| <b>Bit12</b> |

## 6 Device Control

Device Control provides you with device information and allows you to control some device parameters.

### 6.1 General Information

Use [Device User ID](#) to enter a unique device name. This information is retained over power cycles.

Use [Device Indicator Mode](#) to control the status LED. The LED can be active, inactive, or in error mode.

### 6.2 Bandwidth

Information about the bandwidth usage and link speed is provided.

Use [Device Link Throughput Limit](#) to specify what bandwidth is used for the streaming of data. This affects the maximum frame rate. This must be less than the Device Max Throughput.

### 6.3 Timestamp

Use [Timestamp Latch](#) to capture the current timestamp of the device.

### 6.4 Power Supply

Use the [Device Power Supply Selector](#) to choose a power supply, either External or Sensor (Internal). External power is either through the device interface or through GPIO.

### 6.5 Device Reset

Use [Device Reset](#) to soft reboot the camera. Use [Factory Reset](#) to clear any user tables loaded and perform a soft reboot of the camera.

### 6.6 Summary Table

| Name                               | Interface    | Access | Visibility | Description                             |
|------------------------------------|--------------|--------|------------|---|
| <a href="#">Device Scan Type</a>   | IEnumeration | RO     | Expert     | Scan type of the sensor of the device.  |
| <a href="#">Device Vendor Name</a> | IStringReg   |        | Beginner   | Name of the manufacturer of the device. |
| <a href="#">Device Model Name</a>  | IStringReg   |        | Beginner   | Model of the device.                    |
| <a href="#">Sensor</a>             | IStringReg   |        | Guru       | Returns Sensor Description              |

| Name   | Interface    | Access | Visibility | Description  |
|--|--------------|--------|------------|--|
| <a href="#">Description</a>                        |              |        |            |  |
| <a href="#">Device Manufacturer Info</a>           | IStringReg   |        | Beginner   | Manufacturer information about the device.   |
| <a href="#">Firmware Version</a>                   | IStringReg   |        | Beginner   | Version of the firmware on the device.   |
| <a href="#">Serial Number</a>                      | IStringReg   |        | Expert     | Device's serial number. This string is a unique identifier of the device.  |
| <a href="#">User ID</a>                            | IStringReg   |        | Beginner   | User-programmable device identifier.   |
| <a href="#">Device TL Type</a>                     | IEnumeration | RO     | Beginner   | Transport Layer type of the device.  |
| <a href="#">TL Version Major</a>                   | Integer      | RO     | Beginner   | Major version of the Transport Layer of the device.  |
| <a href="#">TL Version Minor</a>                   | Integer      | RO     | Beginner   | Minor version of the Transport Layer of the device.  |
| <a href="#">Device Max Throughput</a>              | Integer      | RO     | Expert     | Maximum bandwidth of the data that can be streamed out of the device. This can be used to estimate if the physical connection(s) can sustain transfer of free-running images from the camera at its maximum speed.             |
| <a href="#">Link Speed</a>                         | Integer      | RO     | Expert     | Indicates the speed of transmission negotiated on the specified Link. (Bps)  |
| <a href="#">Device Link Throughput Limit</a>       | Integer      | RW     | Expert     | Limits the maximum bandwidth of the data that will be streamed out by the device on the selected Link. If necessary, delays will be uniformly inserted between transport layer packets in order to control the peak bandwidth. |
| <a href="#">Device Link Bandwidth Reserve</a>      | IFloat       | RW     | Expert     | Percentage of streamed data bandwidth reserved for packet resend.  |
| <a href="#">Device Link Current Throughput</a>     | Integer      | RO     | Expert     | Current bandwidth of streamed data.  |
| <a href="#">Control Packets Reserved Bandwidth</a> | Integer      | RW     | Expert     | Reserved device link bandwidth for control data.   |
| <a href="#">Stream Channel Count</a>               | Integer      | RO     | Expert     | Indicates the number of streaming channels supported by the device.  |
| <a href="#">Event Channel Count</a>                | Integer      | RO     | Expert     | Indicates the number of event channels supported by the device.  |

| Name  | Interface    | Access | Visibility | Description  |
|---|--------------|--------|------------|--|
| <a href="#">Character Set</a>                                       | IEnumeration | RO     | Guru       | Character set used by the strings of the device`s bootstrap registers.   |
| <a href="#">Device Reset</a>  | ICommand     | WO     | Guru       | This is a command that immediately resets and reboots the device.  |
| <a href="#">Device Indicator Mode</a>                               | IEnumeration |        | Expert     | Controls the LED behaviour: Inactive (off), Active (current status), or Error Status (off unless an error occurs). |
| <a href="#">Registers Endianness</a>                                | IEnumeration | RO     | Guru       | Endianess of the registers of the device.  |
| <a href="#">Device Temperature Selector</a>                         | IEnumeration |        | Expert     | Selects the location within the device, where the temperature will be measured.                                    |
| <a href="#">Device Temperature [Device Temperature Selector]</a>    | IFloat       | RO     | Expert     | Device temperature in degrees Celsius (C).   |
| <a href="#">Timestamp Reset</a>                                     | ICommand     | WO     | Expert     | Resets the current value of the device timestamp counter.  |
| <a href="#">Timestamp Latch</a>                                     | ICommand     | WO     | Expert     | Latches the current timestamp counter into TimestampLatchValue.  |
| <a href="#">Timestamp Latch Value</a>                               | Integer      | RO     | Expert     | Returns the latched value of the timestamp counter.  |
| <a href="#">Device Power Supply Selector</a>                        | IEnumeration |        | Expert     | Selects the power supply source to control or read.  |
| <a href="#">Power Supply Voltage [Device Power Supply Selector]</a> | IFloat       | RO     | Expert     | Indicates the current voltage of the selected power supply (V).  |
| <a href="#">Power Supply Current [Device Power Supply Selector]</a> | IFloat       | RO     | Expert     | Indicates the output current of the selected power supply (A).   |
| <a href="#">Device Uptime</a>                                       | Integer      | RO     | Expert     | Total time since the device was powered up in seconds.   |
| <a href="#">Link Uptime</a>   | Integer      | RO     | Expert     | Time since the last phy negotiation (enumeration).   |
| <a href="#">Enumeration Count</a>                                   | Integer      | RO     | Expert     | Number of enumerations since uptime.   |
| <a href="#">Factory Reset</a>                                       | ICommand     | WO     | Guru       | Returns all user tables to factory default   |

| Name                                  | Interface | Access | Visibility | Description                                    |
|---------------------------------------|-----------|--------|------------|--|
| <a href="#">Max Device Reset Time</a> | Integer   | RO     | Expert     | Time to wait until device reset complete (ms). |

## 6.7 Device Control Features

### 6.7.1 Device Scan Type

Scan type of the sensor of the device.

| Property          | Value          |
|-------------------|----------------|
| <b>Name</b>       | DeviceScanType |
| <b>Interface</b>  | IEnumeration   |
| <b>Access</b>     | RO             |
| <b>Visibility</b> | Expert         |

#### Enumeration Values

Areascan

### 6.7.2 Device Vendor Name

Name of the manufacturer of the device.

| Property          | Value            |
|-------------------|------------------|
| <b>Name</b>       | DeviceVendorName |
| <b>Interface</b>  | IStringReg       |
| <b>Access</b>     |                  |
| <b>Visibility</b> | Beginner         |

### 6.7.3 Device Model Name

Model of the device.

| Property          | Value           |
|-------------------|-----------------|
| <b>Name</b>       | DeviceModelName |
| <b>Interface</b>  | IStringReg      |
| <b>Access</b>     |                 |
| <b>Visibility</b> | Beginner        |

## 6.7.4 Sensor Description

Returns Sensor Description

| Property          | Value             |
|-------------------|-------------------|
| <b>Name</b>       | SensorDescription |
| <b>Interface</b>  | IStringReg        |
| <b>Access</b>     |                   |
| <b>Visibility</b> | Guru              |

## 6.7.5 Device Manufacturer Info

Manufacturer information about the device.

| Property          | Value                  |
|-------------------|------------------------|
| <b>Name</b>       | DeviceManufacturerInfo |
| <b>Interface</b>  | IStringReg             |
| <b>Access</b>     |                        |
| <b>Visibility</b> | Beginner               |

## 6.7.6 Firmware Version

Version of the firmware on the device.

| Property         | Value                 |
|------------------|-----------------------|
| <b>Name</b>      | DeviceFirmwareVersion |
| <b>Interface</b> | IStringReg            |
| <b>Access</b>    |                       |

| Property   | Value    |
|------------|----------|
| Visibility | Beginner |

## 6.7.7 Serial Number

Device's serial number. This string is a unique identifier of the device.

| Property   | Value              |
|------------|--------------------|
| Name       | DeviceSerialNumber |
| Interface  | IStringReg         |
| Access     |                    |
| Visibility | Expert             |

## 6.7.8 User ID

User-programmable device identifier.

| Property   | Value        |
|------------|--------------|
| Name       | DeviceUserID |
| Interface  | IStringReg   |
| Access     |              |
| Visibility | Beginner     |

## 6.7.9 Device TL Type

Transport Layer type of the device.

| Property   | Value        |
|------------|--------------|
| Name       | DeviceTLType |
| Interface  | IEnumeration |
| Access     | RO           |
| Visibility | Beginner     |



### Enumeration Values

|              |
|--------------|
| GigEVision   |
| CameraLink   |
| CameraLinkHS |
| CoaXPress    |
| USB3Vision   |
| Custom       |

## 6.7.10 TL Version Major

Major version of the Transport Layer of the device.

| Property          | Value                |
|-------------------|----------------------|
| <b>Name</b>       | DeviceTLVersionMajor |
| <b>Interface</b>  | Integer              |
| <b>Access</b>     | RO                   |
| <b>Unit</b>       |                      |
| <b>Visibility</b> | Beginner             |

## 6.7.11 TL Version Minor

Minor version of the Transport Layer of the device.

| Property          | Value                |
|-------------------|----------------------|
| <b>Name</b>       | DeviceTLVersionMinor |
| <b>Interface</b>  | Integer              |
| <b>Access</b>     | RO                   |
| <b>Unit</b>       |                      |
| <b>Visibility</b> | Beginner             |

## 6.7.12 Device Max Throughput

Maximum bandwidth of the data that can be streamed out of the device. This can be used to estimate if the physical connection(s) can sustain transfer of free-running images from the camera at its maximum speed.

| Property          | Value               |
|-------------------|---------------------|
| <b>Name</b>       | DeviceMaxThroughput |
| <b>Interface</b>  | Integer             |
| <b>Access</b>     | RO                  |
| <b>Unit</b>       | Bps                 |
| <b>Visibility</b> | Expert              |

### 6.7.13 Link Speed

Indicates the speed of transmission negotiated on the specified Link. (Bps)

| Property          | Value           |
|-------------------|-----------------|
| <b>Name</b>       | DeviceLinkSpeed |
| <b>Interface</b>  | Integer         |
| <b>Access</b>     | RO              |
| <b>Unit</b>       |                 |
| <b>Visibility</b> | Expert          |

### 6.7.14 Device Link Throughput Limit

Limits the maximum bandwidth of the data that will be streamed out by the device on the selected Link. If necessary, delays will be uniformly inserted between transport layer packets in order to control the peak bandwidth.

| Property          | Value                     |
|-------------------|---------------------------|
| <b>Name</b>       | DeviceLinkThroughputLimit |
| <b>Interface</b>  | Integer                   |
| <b>Access</b>     | RW                        |
| <b>Unit</b>       | Bps                       |
| <b>Visibility</b> | Expert                    |

### 6.7.15 Device Link Bandwidth Reserve

Percentage of streamed data bandwidth reserved for packet resend.

| Property          | Value                      |
|-------------------|----------------------------|
| <b>Name</b>       | DeviceLinkBandwidthReserve |
| <b>Interface</b>  | IFloat                     |
| <b>Access</b>     | RW                         |
| <b>Unit</b>       | %                          |
| <b>Visibility</b> | Expert                     |

### 6.7.16 Device Link Current Throughput

Current bandwidth of streamed data.

| Property          | Value                       |
|-------------------|-----------------------------|
| <b>Name</b>       | DeviceLinkCurrentThroughput |
| <b>Interface</b>  | Integer                     |
| <b>Access</b>     | RO                          |
| <b>Unit</b>       | Bps                         |
| <b>Visibility</b> | Expert                      |

### 6.7.17 Control Packets Reserved Bandwidth

Reserved device link bandwidth for control data.

| Property          | Value                           |
|-------------------|---------------------------------|
| <b>Name</b>       | ControlPacketsReservedBandwidth |
| <b>Interface</b>  | Integer                         |
| <b>Access</b>     | RW                              |
| <b>Unit</b>       | Bps                             |
| <b>Visibility</b> | Expert                          |

### 6.7.18 Stream Channel Count

Indicates the number of streaming channels supported by the device.

| Property          | Value                    |
|-------------------|--------------------------|
| <b>Name</b>       | DeviceStreamChannelCount |
| <b>Interface</b>  | Integer                  |
| <b>Access</b>     | RO                       |
| <b>Unit</b>       |                          |
| <b>Visibility</b> | Expert                   |

## 6.7.19 Event Channel Count

Indicates the number of event channels supported by the device.

| Property          | Value                   |
|-------------------|-------------------------|
| <b>Name</b>       | DeviceEventChannelCount |
| <b>Interface</b>  | Integer                 |
| <b>Access</b>     | RO                      |
| <b>Unit</b>       |                         |
| <b>Visibility</b> | Expert                  |

## 6.7.20 Character Set

Character set used by the strings of the device's bootstrap registers.

| Property          | Value              |
|-------------------|--------------------|
| <b>Name</b>       | DeviceCharacterSet |
| <b>Interface</b>  | IEnumeration       |
| <b>Access</b>     | RO                 |
| <b>Visibility</b> | Guru               |

### Enumeration Values

|       |
|-------|
| UTF8  |
| ASCII |

## 6.7.21 Device Reset

This is a command that immediately resets and reboots the device.

| Property          | Value       |
|-------------------|-------------|
| <b>Name</b>       | DeviceReset |
| <b>Interface</b>  | ICommand    |
| <b>Access</b>     | WO          |
| <b>Visibility</b> | Guru        |

## 6.7.22 Device Indicator Mode

Controls the LED behaviour: Inactive (off), Active (current status), or Error Status (off unless an error occurs).

| Property          | Value               |
|-------------------|---------------------|
| <b>Name</b>       | DeviceIndicatorMode |
| <b>Interface</b>  | IEnumeration        |
| <b>Access</b>     |                     |
| <b>Visibility</b> | Expert              |

### Enumeration Values

Inactive

Active

ErrorStatus

## 6.7.23 Registers Endianness

Endianness of the registers of the device.

| Property          | Value                     |
|-------------------|---------------------------|
| <b>Name</b>       | DeviceRegistersEndianness |
| <b>Interface</b>  | IEnumeration              |
| <b>Access</b>     | RO                        |
| <b>Visibility</b> | Guru                      |

#### Enumeration Values

|        |
|--------|
| Little |
| Big    |

### 6.7.24 Device Temperature Selector

Selects the location within the device, where the temperature will be measured.

| Property          | Value                     |
|-------------------|---------------------------|
| <b>Name</b>       | DeviceTemperatureSelector |
| <b>Interface</b>  | IEnumeration              |
| <b>Access</b>     |                           |
| <b>Visibility</b> | Expert                    |

#### Enumeration Values

|        |
|--------|
| Sensor |
|--------|

### 6.7.25 Device Temperature

Device temperature in degrees Celsius (C).

| Property          | Value   |
|-------------------|---|
| <b>Name</b>       | DeviceTemperature <a href="#">[Device Temperature Selector]</a> |
| <b>Interface</b>  | IFloat  |
| <b>Access</b>     | RO  |
| <b>Unit</b>       | C   |
| <b>Visibility</b> | Expert  |

### 6.7.26 Timestamp Reset

Resets the current value of the device timestamp counter.

| Property    | Value          |
|-------------|----------------|
| <b>Name</b> | TimestampReset |

| Property          | Value    |
|-------------------|----------|
| <b>Interface</b>  | ICommand |
| <b>Access</b>     | WO       |
| <b>Visibility</b> | Expert   |

## 6.7.27 Timestamp Latch

Latches the current timestamp counter into TimestampLatchValue.

| Property          | Value          |
|-------------------|----------------|
| <b>Name</b>       | TimestampLatch |
| <b>Interface</b>  | ICommand       |
| <b>Access</b>     | WO             |
| <b>Visibility</b> | Expert         |

## 6.7.28 Timestamp Latch Value

Returns the latched value of the timestamp counter.

| Property          | Value               |
|-------------------|---------------------|
| <b>Name</b>       | TimestampLatchValue |
| <b>Interface</b>  | IInteger            |
| <b>Access</b>     | RO                  |
| <b>Unit</b>       | ns                  |
| <b>Visibility</b> | Expert              |

## 6.7.29 Device Power Supply Selector

Selects the power supply source to control or read.

| Property         | Value                     |
|------------------|---------------------------|
| <b>Name</b>      | DevicePowerSupplySelector |
| <b>Interface</b> | IEnumeration              |

| Property   | Value  |
|------------|--------|
| Access     |        |
| Visibility | Expert |

#### Enumeration Values

|          |
|----------|
| External |
|----------|

### 6.7.30 Power Supply Voltage

Indicates the current voltage of the selected power supply (V).

| Property   | Value   |
|------------|---|
| Name       | PowerSupplyVoltage <a href="#">[Device Power Supply Selector]</a> |
| Interface  | IFloat  |
| Access     | RO  |
| Unit       | V   |
| Visibility | Expert  |

### 6.7.31 Power Supply Current

Indicates the output current of the selected power supply (A).

| Property   | Value   |
|------------|---|
| Name       | PowerSupplyCurrent <a href="#">[Device Power Supply Selector]</a> |
| Interface  | IFloat  |
| Access     | RO  |
| Unit       | A   |
| Visibility | Expert  |

### 6.7.32 Device Uptime

Total time since the device was powered up in seconds.



| Property          | Value        |
|-------------------|--------------|
| <b>Name</b>       | DeviceUptime |
| <b>Interface</b>  | Integer      |
| <b>Access</b>     | RO           |
| <b>Unit</b>       | s            |
| <b>Visibility</b> | Expert       |

### 6.7.33 Link Uptime

Time since the last phy negotiation (enumeration).

| Property          | Value      |
|-------------------|------------|
| <b>Name</b>       | LinkUptime |
| <b>Interface</b>  | Integer    |
| <b>Access</b>     | RO         |
| <b>Unit</b>       | s          |
| <b>Visibility</b> | Expert     |

### 6.7.34 Enumeration Count

Number of enumerations since uptime.

| Property          | Value            |
|-------------------|------------------|
| <b>Name</b>       | EnumerationCount |
| <b>Interface</b>  | Integer          |
| <b>Access</b>     | RO               |
| <b>Unit</b>       |                  |
| <b>Visibility</b> | Expert           |

### 6.7.35 Factory Reset

Returns all user tables to factory default

| Property          | Value        |
|-------------------|--------------|
| <b>Name</b>       | FactoryReset |
| <b>Interface</b>  | ICommand     |
| <b>Access</b>     | WO           |
| <b>Visibility</b> | Guru         |

## 6.7.36 Max Device Reset Time

Time to wait until device reset complete (ms).

| Property          | Value              |
|-------------------|--------------------|
| <b>Name</b>       | MaxDeviceResetTime |
| <b>Interface</b>  | IInteger           |
| <b>Access</b>     | RO                 |
| <b>Unit</b>       | ms                 |
| <b>Visibility</b> | Expert             |

# 7 Transport Layer Control

The Transport Layer control provides the following information:

**Gev IEEE 1588** - Enables IEEE 1588 Precision Time Protocol (PTP) to control the timestamp register.

**Gev IEEE 1588 Clock Accuracy** - The expected accuracy of the device clock when it is the grandmaster or when it becomes the grandmaster.

**Gev IEEE 1588 Status** - The status of the IEEE 1588 clock.

**Gev IEEE 1588 Mode** - The mode of the IEEE 1588 clock.

## 7.1 Summary Table

| Name   | Interface | Access | Visibility | Description  |
|--|-----------|--------|------------|--|
| <a href="#">Payload Size</a>                         | Integer   |        | Expert     | Provides the number of bytes transferred for each image or chunk on the stream channel.          |
| <a href="#">GigE Vision</a>                          | ICategory | RO     | Beginner   | Category that contains the features pertaining to the GigE Vision transport layer of the device. |
| <a href="#">Link Error Count</a>                     | Integer   | RO     | Expert     | Counts the number of error on the link.  |
| <a href="#">Packet Resend Request Count</a>          | Integer   | RO     | Expert     | Counts the number of resend requests received from the host.                                     |
| <a href="#">Packet Resend Requests Dropped Count</a> | Integer   | RO     | Expert     | Counts the number of resend requests that were not processed due to an error condition.          |

## 7.2 Transport Layer Control Features

### 7.2.1 Payload Size

Provides the number of bytes transferred for each image or chunk on the stream channel.

| Property         | Value       |
|------------------|-------------|
| <b>Name</b>      | PayloadSize |
| <b>Interface</b> | Integer     |
| <b>Access</b>    |             |

| Property   | Value  |
|------------|--------|
| Unit       |        |
| Visibility | Expert |

## 7.2.2 GigE Vision

Category that contains the features pertaining to the GigE Vision transport layer of the device.

| Property   | Value      |
|------------|------------|
| Name       | GigEVision |
| Interface  | ICategory  |
| Access     | RO         |
| Visibility | Beginner   |

## 7.2.3 Link Error Count

Counts the number of error on the link.

| Property   | Value          |
|------------|----------------|
| Name       | LinkErrorCount |
| Interface  | Integer        |
| Access     | RO             |
| Unit       |                |
| Visibility | Expert         |

## 7.2.4 Packet Resend Request Count

Counts the number of resend requests received from the host.

| Property  | Value                    |
|-----------|--------------------------|
| Name      | PacketResendRequestCount |
| Interface | Integer                  |
| Access    | RO                       |

| Property   | Value  |
|------------|--------|
| Unit       |        |
| Visibility | Expert |

## 7.2.5 Packet Resend Requests Dropped Count

Counts the number of resend requests that were not processed due to an error condition.

| Property   | Value                            |
|------------|----------------------------------|
| Name       | PacketResendRequestsDroppedCount |
| Interface  | Integer                          |
| Access     | RO                               |
| Unit       |                                  |
| Visibility | Expert                           |

## 7.3 GigE Vision

Category that contains the features pertaining to the GigE Vision transport layer of the device.

### 7.3.1 Summary Table

| Name  | Interface    | Access | Visibility | Description   |
|---|--------------|--------|------------|---|
| <a href="#">Supported Option Selector</a>                         | IEnumeration | RW     | Expert     | Selects the GEV option to interrogate for existing support.   |
| <a href="#">Supported Option [Supported Option Selector]</a>      | IBoolean     | RO     | Expert     | Returns if the selected GEV option is supported.  |
| <a href="#">Interface Selector</a>                                | Integer      | RW     | Beginner   | Selects which logical link to control.  |
| <a href="#">MAC Address [Interface Selector]</a>                  | Integer      |        | Beginner   | MAC address of the logical link.  |
| <a href="#">Current IP Configuration LLA [Interface Selector]</a> | IBoolean     | RW     | Beginner   | Controls whether the Link Local Address IP configuration scheme is activated on the given logical link. |

| Name  | Interface  | Access | Visibility | Description   |
|---|------------|--------|------------|---|
| <a href="#">Selector</a> ]  |            |        |            |   |
| <a href="#">Current IP Configuration DHCP [Interface Selector]</a>          | IBoolean   | RW     | Beginner   | Controls whether the DHCP IP configuration scheme is activated on the given logical link.           |
| <a href="#">Current IP Configuration Persistent IP [Interface Selector]</a> | IBoolean   | RW     | Beginner   | Controls whether the PersistentIP configuration scheme is activated on the given logical link.      |
| <a href="#">Current IP Address [Interface Selector]</a>                     | Integer    | RO     | Beginner   | Reports the IP address for the given logical link.  |
| <a href="#">Current Subnet Mask [Interface Selector]</a>                    | Integer    | RO     | Beginner   | Reports the subnet mask of the given logical link.  |
| <a href="#">Current Default Gateway [Interface Selector]</a>                | Integer    | RO     | Beginner   | Reports the default gateway IP address to be used on the given logical link.                        |
| <a href="#">First URL</a>   | IStringReg |        | Guru       | The first choice of URL for the XML device description file.  |
| <a href="#">Second URL</a>  | IStringReg |        | Guru       | The second choice of URL to the XML device description file.  |
| <a href="#">Number Of Interfaces</a>  | Integer    | RO     | Expert     | Indicates the number of physical network interfaces supported by this device.                       |
| <a href="#">Persistent IP Address [Interface Selector]</a>                  | Integer    |        | Beginner   | Controls the Persistent IP address for this logical link.   |
| <a href="#">Persistent Subnet Mask [Interface Selector]</a>                 | Integer    |        | Beginner   | Controls the Persistent subnet mask associated with the Persistent IP address on this logical link. |
| <a href="#">Persistent Default Gateway [Interface Selector]</a>             | Integer    |        | Beginner   | Controls the persistent default gateway for this logical link.                                      |

| Name  | Interface   | Access | Visibility | Description   |
|---|-------------|--------|------------|---|
| <a href="#">Heartbeat Timeout</a>                                       | Integer     |        | Guru       | Indicates the current heartbeat timeout in milliseconds.  |
| <a href="#">Timestamp Tick Frequency</a>                                | Integer     | RO     | Expert     | Indicates the number of timestamp ticks in 1 second (frequency in Hz).  |
| <a href="#">Pending Acknowledge Enable</a>                              | Boolean     | RW     | Guru       | Enables the generation of PENDING_ACK.  |
| <a href="#">Heartbeat Disable</a>                                       | Boolean     | RW     | Expert     | Disables the GVCP heartbeat.  |
| <a href="#">Pending Timeout</a>   | Integer     | RO     | Guru       | Indicates the longest GVCP command execution time before the device returns a PENDING_ACK in milliseconds.  |
| <a href="#">IEEE 1588</a>   | Boolean     | RW     | Expert     | Enables the IEEE 1588 Precision Time Protocol to control the timestamp register.  |
| <a href="#">IEEE 1588 Status</a>  | Enumeration | RO     | Expert     | Provides the status of the IEEE 1588 clock.   |
| <a href="#">CCP</a>   | Enumeration | RW     | Guru       | Controls the device access privilege of an application.   |
| <a href="#">MCP Host Port</a>   | Integer     | RW     | Guru       | The port to which the device must send messages   |
| <a href="#">Message Channel Destination Address</a>                     | Integer     | RW     | Guru       | Controls the destination IP address of the message channel  |
| <a href="#">Message Channel Transmission Timeout</a>                    | Integer     | RO     | Guru       | Indicates the transmission timeout of the message channel.  |
| <a href="#">Message Channel Retry Count</a>                             | Integer     | RO     | Guru       | Indicates the number of retries of the message channel.   |
| <a href="#">Message Channel Source Port</a>                             | Integer     | RO     | Guru       | Indicates the source port of the message channel.   |
| <a href="#">Stream Channel Selector</a>                                 | Integer     |        | Expert     | Selects the stream channel to control.  |
| <a href="#">SCCFG Unconditional Streaming [Stream Channel Selector]</a> | Boolean     | RW     | Guru       | Enables the camera to continue to stream, for this stream channel, if its control channel is closed or regardless of the reception of any ICMP messages (such as destination unreachable messages). |
| <a href="#">Gev SCCFG Extended Chunk Data [Stream</a>                   | Boolean     | RW     | Guru       | Enables cameras to use the extended chunk data payload type for this stream channel.  |

| Name   | Interface | Access | Visibility | Description   |
|--|-----------|--------|------------|---|
| <a href="#">Channel Selector</a>   |           |        |            |   |
| <a href="#">SCP Direction [Stream Channel Selector]</a>                      | Integer   | RO     | Guru       | Transmit or Receive of the channel  |
| <a href="#">SCP Interface Index [Stream Channel Selector]</a>                | Integer   | RO     | Guru       | Index of the logical link to use.   |
| <a href="#">SCP Host Port [Stream Channel Selector]</a>                      | Integer   | RW     | Guru       | Controls the port of the selected channel to which a GVSP transmitter must send data stream or the port from which a GVSP receiver may receive data stream.   |
| <a href="#">SCPS Fire Test Packet [Stream Channel Selector]</a>              | Boolean   | RW     | Guru       | Sends a test packet.  |
| <a href="#">SCPS Do Not Fragment [Stream Channel Selector]</a>               | Boolean   | RW     | Guru       | The state of this feature is copied into the "do not fragment" bit of the IP header of each stream packet.  |
| <a href="#">SCPS Big Endian [Stream Channel Selector]</a>                    | Boolean   | RW     | Guru       | Endianess of multi-byte pixel data for this stream.   |
| <a href="#">SCPS Packet Size [Stream Channel Selector]</a>                   | Integer   | RW     | Expert     | Specifies the stream packet size (in bytes) to send on this channel.  |
| <a href="#">Stream Channel Packet Delay [Stream Channel Selector]</a>        | Integer   | RW     | Expert     | Controls the delay (in GEV timestamp counter unit) to insert between each packet for this stream channel. This can be used as a crude flow-control mechanism if the application or the network infrastructure cannot keep up with the packets coming from the device. |
| <a href="#">Stream Channel Destination Address [Stream Channel Selector]</a> | Integer   | RW     | Guru       | Controls the destination IP address of the selected stream channel to which a GVSP transmitter must send data stream or the destination IP address from which a GVSP receiver may receive data stream.  |
| <a href="#">Stream Channel Source Port [Stream Channel Selector]</a>         | Integer   | RO     | Guru       | Indicates the source port of the stream channel.  |



| Name                           | Interface    | Access | Visibility | Description                               |
|--------------------------------|--------------|--------|------------|---|
| <a href="#">Selector</a>       |              |        |            |   |
| <a href="#">IEEE 1588 Mode</a> | IEnumeration | RW     | Expert     | Provides the mode of the IEEE 1588 clock. |

## 7.3.2 GigE Vision Features

### 7.3.2.1 Supported Option Selector

Selects the GEV option to interrogate for existing support.

| Property          | Value                      |
|-------------------|----------------------------|
| <b>Name</b>       | GevSupportedOptionSelector |
| <b>Interface</b>  | IEnumeration               |
| <b>Access</b>     | RW                         |
| <b>Visibility</b> | Expert                     |

#### Enumeration Values

|                           |
|---------------------------|
| UserDefinedName           |
| SerialNumber              |
| HeartbeatDisable          |
| LinkSpeed                 |
| CCPApplicationSocket      |
| ManifestTable             |
| TestData                  |
| DiscoveryAckDelay         |
| DiscoveryAckDelayWritable |
| ExtendedStatusCodes       |
| Action                    |
| PendingAck                |
| EventData                 |

### Enumeration Values

|                             |
|-----------------------------|
| Event                       |
| PacketResend                |
| WriteMem                    |
| CommandsConcatenation       |
| IPConfigurationLLA          |
| IPConfigurationDHCP         |
| IPConfigurationPersistentIP |
| StreamChannelSourceSocket   |
| MessageChannelSourceSocket  |

### 7.3.2.2 Supported Option

Returns if the selected GEV option is supported.

| Property          | Value  |
|-------------------|--|
| <b>Name</b>       | GevSupportedOption <a href="#">[Supported Option Selector]</a> |
| <b>Interface</b>  | IBoolean   |
| <b>Access</b>     | RO   |
| <b>Visibility</b> | Expert   |

### 7.3.2.3 Interface Selector

Selects which logical link to control.

| Property          | Value                |
|-------------------|----------------------|
| <b>Name</b>       | GevInterfaceSelector |
| <b>Interface</b>  | IInteger             |
| <b>Access</b>     | RW                   |
| <b>Unit</b>       |                      |
| <b>Visibility</b> | Beginner             |
| <b>Value</b>      | 0                    |

### 7.3.2.4 MAC Address

MAC address of the logical link.

| Property          | Value  |
|-------------------|--|
| <b>Name</b>       | GevMACAddress <a href="#">[Interface Selector]</a> |
| <b>Interface</b>  | Integer  |
| <b>Access</b>     |  |
| <b>Unit</b>       |  |
| <b>Visibility</b> | Beginner   |

### 7.3.2.5 Current IP Configuration LLA

Controls whether the Link Local Address IP configuration scheme is activated on the given logical link.

| Property          | Value   |
|-------------------|---|
| <b>Name</b>       | GevCurrentIPConfigurationLLA <a href="#">[Interface Selector]</a> |
| <b>Interface</b>  | IBoolean  |
| <b>Access</b>     | RW  |
| <b>Visibility</b> | Beginner  |

### 7.3.2.6 Current IP Configuration DHCP

Controls whether the DHCP IP configuration scheme is activated on the given logical link.

| Property          | Value  |
|-------------------|--|
| <b>Name</b>       | GevCurrentIPConfigurationDHCP <a href="#">[Interface Selector]</a> |
| <b>Interface</b>  | IBoolean   |
| <b>Access</b>     | RW   |
| <b>Visibility</b> | Beginner   |

### 7.3.2.7 Current IP Configuration Persistent IP

Controls whether the PersistentIP configuration scheme is activated on the given logical link.

| Property    | Value  |
|-------------|--|
| <b>Name</b> | GevCurrentIPConfigurationPersistentIP <a href="#">[Interface Selector]</a> |

| Property          | Value    |
|-------------------|----------|
| <b>Interface</b>  | IBoolean |
| <b>Access</b>     | RW       |
| <b>Visibility</b> | Beginner |

### 7.3.2.8 Current IP Address

Reports the IP address for the given logical link.

| Property          | Value  |
|-------------------|--|
| <b>Name</b>       | GevCurrentIPAddress <a href="#">[Interface Selector]</a> |
| <b>Interface</b>  | Integer  |
| <b>Access</b>     | RO   |
| <b>Unit</b>       |  |
| <b>Visibility</b> | Beginner   |

### 7.3.2.9 Current Subnet Mask

Reports the subnet mask of the given logical link.

| Property          | Value   |
|-------------------|---|
| <b>Name</b>       | GevCurrentSubnetMask <a href="#">[Interface Selector]</a> |
| <b>Interface</b>  | Integer   |
| <b>Access</b>     | RO  |
| <b>Unit</b>       |   |
| <b>Visibility</b> | Beginner  |

### 7.3.2.10 Current Default Gateway

Reports the default gateway IP address to be used on the given logical link.

| Property         | Value   |
|------------------|---|
| <b>Name</b>      | GevCurrentDefaultGateway <a href="#">[Interface Selector]</a> |
| <b>Interface</b> | Integer   |

| Property          | Value    |
|-------------------|----------|
| <b>Access</b>     | RO       |
| <b>Unit</b>       |          |
| <b>Visibility</b> | Beginner |

### 7.3.2.11 First URL

The first choice of URL for the XML device description file.

| Property          | Value       |
|-------------------|-------------|
| <b>Name</b>       | GevFirstURL |
| <b>Interface</b>  | IStringReg  |
| <b>Access</b>     |             |
| <b>Visibility</b> | Guru        |

### 7.3.2.12 Second URL

The second choice of URL to the XML device description file.

| Property          | Value        |
|-------------------|--------------|
| <b>Name</b>       | GevSecondURL |
| <b>Interface</b>  | IStringReg   |
| <b>Access</b>     |              |
| <b>Visibility</b> | Guru         |

### 7.3.2.13 Number Of Interfaces

Indicates the number of physical network interfaces supported by this device.

| Property          | Value                 |
|-------------------|-----------------------|
| <b>Name</b>       | GevNumberOfInterfaces |
| <b>Interface</b>  | Integer               |
| <b>Access</b>     | RO                    |
| <b>Unit</b>       |                       |
| <b>Visibility</b> | Expert                |

### 7.3.2.14 Persistent IP Address

Controls the Persistent IP address for this logical link.

| Property          | Value   |
|-------------------|---|
| <b>Name</b>       | GevPersistentIPAddress <a href="#">[Interface Selector]</a> |
| <b>Interface</b>  | Integer   |
| <b>Access</b>     |   |
| <b>Unit</b>       |   |
| <b>Visibility</b> | Beginner  |

### 7.3.2.15 Persistent Subnet Mask

Controls the Persistent subnet mask associated with the Persistent IP address on this logical link.

| Property          | Value  |
|-------------------|--|
| <b>Name</b>       | GevPersistentSubnetMask <a href="#">[Interface Selector]</a> |
| <b>Interface</b>  | Integer  |
| <b>Access</b>     |  |
| <b>Unit</b>       |  |
| <b>Visibility</b> | Beginner   |

### 7.3.2.16 Persistent Default Gateway

Controls the persistent default gateway for this logical link.

| Property          | Value  |
|-------------------|--|
| <b>Name</b>       | GevPersistentDefaultGateway <a href="#">[Interface Selector]</a> |
| <b>Interface</b>  | Integer  |
| <b>Access</b>     |  |
| <b>Unit</b>       |  |
| <b>Visibility</b> | Beginner   |

### 7.3.2.17 Heartbeat Timeout

Indicates the current heartbeat timeout in milliseconds.

| Property          | Value               |
|-------------------|---------------------|
| <b>Name</b>       | GevHeartbeatTimeout |
| <b>Interface</b>  | Integer             |
| <b>Access</b>     |                     |
| <b>Unit</b>       |                     |
| <b>Visibility</b> | Guru                |

### 7.3.2.18 Timestamp Tick Frequency

Indicates the number of timestamp ticks in 1 second (frequency in Hz).

| Property          | Value                     |
|-------------------|---------------------------|
| <b>Name</b>       | GevTimestampTickFrequency |
| <b>Interface</b>  | Integer                   |
| <b>Access</b>     | RO                        |
| <b>Unit</b>       |                           |
| <b>Visibility</b> | Expert                    |

### 7.3.2.19 Pending Acknowledge Enable

Enables the generation of PENDING\_ACK.

| Property          | Value             |
|-------------------|-------------------|
| <b>Name</b>       | GevGVCPPendingAck |
| <b>Interface</b>  | Boolean           |
| <b>Access</b>     | RW                |
| <b>Visibility</b> | Guru              |

### 7.3.2.20 Heartbeat Disable

Disables the GVCP heartbeat.

| Property    | Value                   |
|-------------|-------------------------|
| <b>Name</b> | GevGVCPHeartbeatDisable |

| Property          | Value    |
|-------------------|----------|
| <b>Interface</b>  | IBoolean |
| <b>Access</b>     | RW       |
| <b>Visibility</b> | Expert   |

### 7.3.2.21 Pending Timeout

Indicates the longest GVCP command execution time before the device returns a PENDING\_ACK in milliseconds.

| Property          | Value                |
|-------------------|----------------------|
| <b>Name</b>       | GevGVCPendingTimeout |
| <b>Interface</b>  | Integer              |
| <b>Access</b>     | RO                   |
| <b>Unit</b>       |                      |
| <b>Visibility</b> | Guru                 |

### 7.3.2.22 IEEE 1588

Enables the IEEE 1588 Precision Time Protocol to control the timestamp register.

| Property          | Value       |
|-------------------|-------------|
| <b>Name</b>       | GevIEEE1588 |
| <b>Interface</b>  | IBoolean    |
| <b>Access</b>     | RW          |
| <b>Visibility</b> | Expert      |

### 7.3.2.23 IEEE 1588 Status

Provides the status of the IEEE 1588 clock.

| Property          | Value             |
|-------------------|-------------------|
| <b>Name</b>       | GevIEEE1588Status |
| <b>Interface</b>  | IEnumeration      |
| <b>Access</b>     | RO                |
| <b>Visibility</b> | Expert            |



### Enumeration Values

|              |
|--------------|
| Initializing |
| Faulty       |
| Disabled     |
| Listening    |
| PreMaster    |
| Master       |
| Passive      |
| Uncalibrated |
| Slave        |

## 7.3.2.24 CCP

Controls the device access privilege of an application.

| Property | Value |
|----------|-------|
|----------|-------|

|                   |              |
|-------------------|--------------|
| <b>Name</b>       | GevCCP       |
| <b>Interface</b>  | IEnumeration |
| <b>Access</b>     | RW           |
| <b>Visibility</b> | Guru         |

### Enumeration Values

|                 |
|-----------------|
| OpenAccess      |
| ExclusiveAccess |
| ControlAccess   |

## 7.3.2.25 MCP Host Port

The port to which the device must send messages

| Property | Value |
|----------|-------|
|----------|-------|

|             |                |
|-------------|----------------|
| <b>Name</b> | GevMCPHostPort |
|-------------|----------------|

| Property          | Value   |
|-------------------|---------|
| <b>Interface</b>  | Integer |
| <b>Access</b>     | RW      |
| <b>Unit</b>       |         |
| <b>Visibility</b> | Guru    |

### 7.3.2.26 Message Channel Destination Address

Controls the destination IP address of the message channel

| Property          | Value   |
|-------------------|---------|
| <b>Name</b>       | GevMCDA |
| <b>Interface</b>  | Integer |
| <b>Access</b>     | RW      |
| <b>Unit</b>       |         |
| <b>Visibility</b> | Guru    |

### 7.3.2.27 Message Channel Transmission Timeout

Indicates the transmission timeout of the message channel.

| Property          | Value   |
|-------------------|---------|
| <b>Name</b>       | GevMCTT |
| <b>Interface</b>  | Integer |
| <b>Access</b>     | RO      |
| <b>Unit</b>       |         |
| <b>Visibility</b> | Guru    |

### 7.3.2.28 Message Channel Retry Count

Indicates the number of retries of the message channel.

| Property    | Value   |
|-------------|---------|
| <b>Name</b> | GevMCRC |

| Property          | Value   |
|-------------------|---------|
| <b>Interface</b>  | Integer |
| <b>Access</b>     | RO      |
| <b>Unit</b>       |         |
| <b>Visibility</b> | Guru    |

### 7.3.2.29 Message Channel Source Port

Indicates the source port of the message channel.

| Property          | Value   |
|-------------------|---------|
| <b>Name</b>       | GevMCSP |
| <b>Interface</b>  | Integer |
| <b>Access</b>     | RO      |
| <b>Unit</b>       |         |
| <b>Visibility</b> | Guru    |

### 7.3.2.30 Stream Channel Selector

Selects the stream channel to control.

| Property          | Value                    |
|-------------------|--------------------------|
| <b>Name</b>       | GevStreamChannelSelector |
| <b>Interface</b>  | Integer                  |
| <b>Access</b>     |                          |
| <b>Unit</b>       |                          |
| <b>Visibility</b> | Expert                   |
| <b>Value</b>      | 0                        |

### 7.3.2.31 SCCFG Unconditional Streaming

Enables the camera to continue to stream, for this stream channel, if its control channel is closed or regardless of the reception of any ICMP messages (such as destination unreachable messages).

| Property          | Value  |
|-------------------|--|
| <b>Name</b>       | GevSCCFGUnconditionalStreaming <a href="#">[Stream Channel Selector]</a> |
| <b>Interface</b>  | IBoolean   |
| <b>Access</b>     | RW   |
| <b>Visibility</b> | Guru   |

### 7.3.2.32 Gev SCCFG Extended Chunk Data

Enables cameras to use the extended chunk data payload type for this stream channel.

| Property          | Value   |
|-------------------|---|
| <b>Name</b>       | GevSCCFGExtendedChunkData <a href="#">[Stream Channel Selector]</a> |
| <b>Interface</b>  | IBoolean  |
| <b>Access</b>     | RW  |
| <b>Visibility</b> | Guru  |

### 7.3.2.33 SCP Direction

Transmit or Receive of the channel

| Property          | Value   |
|-------------------|---|
| <b>Name</b>       | GevSCPDirection <a href="#">[Stream Channel Selector]</a> |
| <b>Interface</b>  | IInteger  |
| <b>Access</b>     | RO  |
| <b>Unit</b>       |   |
| <b>Visibility</b> | Guru  |

### 7.3.2.34 SCP Interface Index

Index of the logical link to use.

| Property         | Value  |
|------------------|--|
| <b>Name</b>      | GevSCPInterfaceIndex <a href="#">[Stream Channel Selector]</a> |
| <b>Interface</b> | IInteger   |

| Property          | Value |
|-------------------|-------|
| <b>Access</b>     | RO    |
| <b>Unit</b>       |       |
| <b>Visibility</b> | Guru  |

### 7.3.2.35 SCP Host Port

Controls the port of the selected channel to which a GVSP transmitter must send data stream or the port from which a GVSP receiver may receive data stream.

| Property          | Value  |
|-------------------|--|
| <b>Name</b>       | GevSCPHostPort <a href="#">[Stream Channel Selector]</a> |
| <b>Interface</b>  | Integer  |
| <b>Access</b>     | RW   |
| <b>Unit</b>       |  |
| <b>Visibility</b> | Guru   |

### 7.3.2.36 SCPS Fire Test Packet

Sends a test packet.

| Property          | Value   |
|-------------------|---|
| <b>Name</b>       | GevSCPSFireTestPacket <a href="#">[Stream Channel Selector]</a> |
| <b>Interface</b>  | IBoolean  |
| <b>Access</b>     | RW  |
| <b>Visibility</b> | Guru  |

### 7.3.2.37 SCPS Do Not Fragment

The state of this feature is copied into the "do not fragment" bit of the IP header of each stream packet.

| Property         | Value  |
|------------------|--|
| <b>Name</b>      | GevSCPSDoNotFragment <a href="#">[Stream Channel Selector]</a> |
| <b>Interface</b> | IBoolean   |
| <b>Access</b>    | RW   |

| Property   | Value |
|------------|-------|
| Visibility | Guru  |

### 7.3.2.38 SCPS Big Endian

Endianness of multi-byte pixel data for this stream.

| Property   | Value  |
|------------|--|
| Name       | GevSCPSBigEndian <a href="#">[Stream Channel Selector]</a> |
| Interface  | IBoolean   |
| Access     | RW   |
| Visibility | Guru   |

### 7.3.2.39 SCPS Packet Size

Specifies the stream packet size (in bytes) to send on this channel.

| Property   | Value  |
|------------|--|
| Name       | GevSCSPacketSize <a href="#">[Stream Channel Selector]</a> |
| Interface  | Integer  |
| Access     | RW   |
| Unit       |  |
| Visibility | Expert   |

### 7.3.2.40 Stream Channel Packet Delay

Controls the delay (in GEV timestamp counter unit) to insert between each packet for this stream channel. This can be used as a crude flow-control mechanism if the application or the network infrastructure cannot keep up with the packets coming from the device.

| Property   | Value   |
|------------|---|
| Name       | GevSCPD <a href="#">[Stream Channel Selector]</a> |
| Interface  | Integer   |
| Access     | RW  |
| Unit       |   |
| Visibility | Expert  |

### 7.3.2.41 Stream Channel Destination Address

Controls the destination IP address of the selected stream channel to which a GVSP transmitter must send data stream or the destination IP address from which a GVSP receiver may receive data stream.

| Property          | Value   |
|-------------------|---|
| <b>Name</b>       | GevSCDA <a href="#">[Stream Channel Selector]</a> |
| <b>Interface</b>  | Integer   |
| <b>Access</b>     | RW  |
| <b>Unit</b>       |   |
| <b>Visibility</b> | Guru  |

### 7.3.2.42 Stream Channel Source Port

Indicates the source port of the stream channel.

| Property          | Value   |
|-------------------|---|
| <b>Name</b>       | GevSCSP <a href="#">[Stream Channel Selector]</a> |
| <b>Interface</b>  | Integer   |
| <b>Access</b>     | RO  |
| <b>Unit</b>       |   |
| <b>Visibility</b> | Guru  |

### 7.3.2.43 IEEE 1588 Mode

Provides the mode of the IEEE 1588 clock.

| Property          | Value           |
|-------------------|-----------------|
| <b>Name</b>       | GevIEEE1588Mode |
| <b>Interface</b>  | IEnumeration    |
| <b>Access</b>     | RW              |
| <b>Visibility</b> | Expert          |

#### Enumeration Values

Auto

### Enumeration Values

SlaveOnly



# 8 Sequencer Control

The purpose of a sequencer is to allow you to programmatically control the acquisition parameters of an image sequence. You can define not only how the images are captured (i.e. the camera feature settings) but also when the camera transitions from one acquisition setting to another. This is akin to a state machine diagram where the states correspond to the sequencer set feature settings, and the transition among states corresponds to a particular event that triggers the state machine to move from one state to another.

The features to configure and deploy the sequencer are grouped under the Sequencer Control category.

## 8.1 Sequenced Feature Settings

The feature settings used in a sequence set are a combination of the features specifically configured for the set and what was active when the set was saved. Because many of the camera features are dependently linked to each other, settings may be saved to a set that are outside of the sequencer configuration.

Sequencer features can be classified as follows:

**Direct** - direct features are those you define as being part of the set with specified values which may vary from one set to another and are independently recorded for each set. Examples include: exposure time, gain, resolution, and offset.

**Implied** - implied features are those that are dependent on the direct features. Their settings are recorded for each set. While you do not define their values as part of the set, they are included so that their values are valid. They can be modified during the configuration of a set, but are locked during sequencer operation.

**Fixed** - fixed features are those that are the preconditions to implied or direct features. These settings are recorded to guarantee the sequenced features are valid. Fixed features have a single value for the entire sequence. This is locked during sequencer configuration and operation.

**Forced** - forced features are those whose settings are predefined. These are automatic features that if enabled would control other features and invalidate the settings. They are forced into the Off (manual) mode during sequencer operation. During sequencer configuration, they are modifiable, to allow you to achieve the desired conditions which can then be recorded for later operation.

**Non-sequenced** - non-sequenced are features that are not controlled or affected by the sequencer.

The following diagram provides an example of a web of features and how they are classified based on the fact that a single feature B has been directly sequenced:

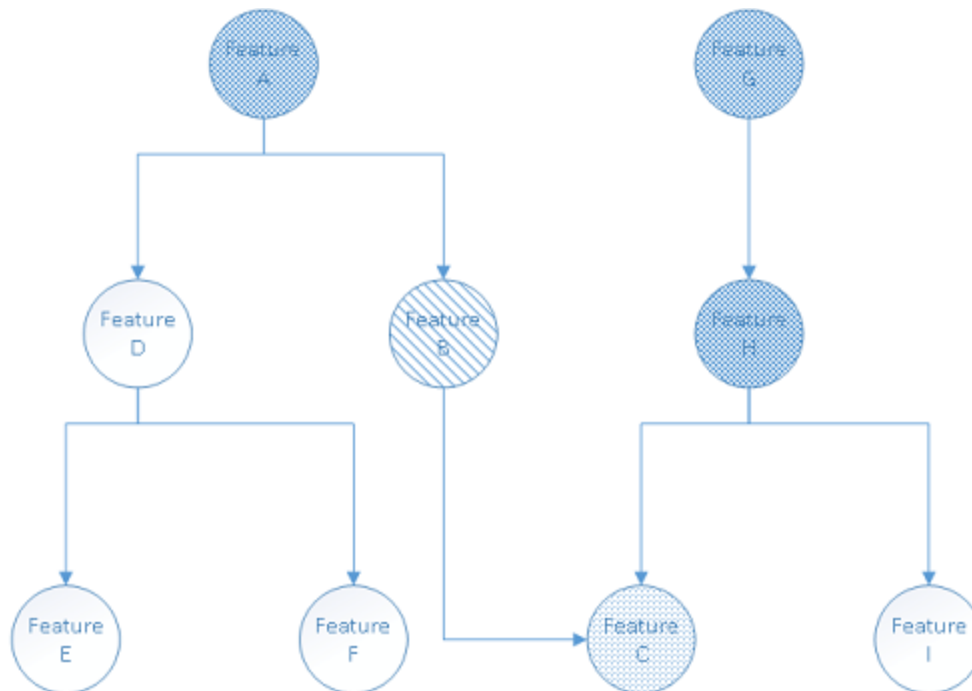

Here is an explanation of how the types of various features are resolved:

- **Direct** - Feature B is the only feature you have requested to be sequenced, making it the sole directly sequenced feature.
- **Implied** - The operational range of feature C is directly affected by feature B, hence it must be sequenced but it is implied only.
- **Fixed** - Feature A controls the operational range of feature B, so it must be fixed to guarantee that the recorded feature B value is legal. Feature C depends on feature H, so it must be fixed. Feature H in turn depends on feature G, so it too must be fixed.
- **Non-sequenced** - Features D, E, and I are not included in the sequence.

## 8.1.1 Sequencer Configuration

The configuration of a sequencer can be broken down into a number of distinct steps :

### 1. Enable the direct features.

Use the [SequencerFeatureSelector](#) to select which features to directly sequence and set [SequencerFeatureEnable](#) to enabled.

Enabling the direct features must be done prior to entering configuration mode as it determines those features that are defined, implied, fixed, and forced. The enabled features are active for all sequencer sets.

### 2. Enter configuration mode.

Set [SequencerConfigurationMode](#) to On.

When you enter configuration mode, the camera determines those features which are implied and fixed and locks the fixed features from being modified. If any fixed features need to be adjusted, exit configuration mode by setting [SequencerConfigurationMode](#) to Off. Make the necessary modifications and enter configuration mode again.

### 3. Configure the features for each sequencer set.

Use [SequencerSetSelector](#) to choose the set to configure. Adjust the features as needed to achieve the desired image. Use the [SequencerSetSave](#) command to save the settings to the selected sequencer set.

Once a set is saved, the camera checks that all the settings are valid. [SequencerSetValid](#) displays the results of this check. If the sequencer set is not valid, adjust the settings and save the set again.

**Note:** other previously saved and valid sets may become invalid when a set is saved with a new configuration.

Up to 8 sets can be configured and saved.

Once a sequencer set has been configured and is valid, it can be loaded to the active camera at anytime, just like a [User Set](#). The difference between a User Set and a Sequencer Set is the range of features affected. You can load a sequencer set via [SequencerSetLoad](#) at anytime, not just in configuration mode.

Loading is particularly useful when trying to configure multiple sets which may share a similar setup with only minor differences. In that case, you can load an already configured set, select a different set, modify features that are different, and save.

### 4. Configure the transition between sets.

You must define paths for the sequencer to transition from one set to another. Use [SequencerSetSelector](#) to select the set. Then use [SequencerPathSelector](#) to select the path. The current implementation only support a single path for each set.

This path defines the event that causes the transition and the next set to which that it transitions. Use [SequencerTriggerSource](#) to specify the internal signal or physical input line to use as the trigger source. Use [SequencerTriggerActivation](#) to specify the activation mode of the selected trigger source.

Use [SequencerSetNext](#) to specify which set follows the transition.

**Note:** The order of steps 3 and 4 is not important, as long as the correct set has been chosen via the [SequencerSetSelector](#).

### 5. Configure the starting set.

Use [SequencerSetStart](#) to define which set begins the sequencer operation when it is executed.

### 6. Exit configuration mode.

Set [SequencerConfigurationMode](#) to Off.

Once you have exited configuration mode, the camera checks that the sequencer configuration is valid. [SequencerConfigurationValid](#) displays the results of this check. If the configuration is not valid, enter configuration mode to adjust the settings.

## 8.1.2 Sequencer Execution

**Note:** Before you can execute a sequencer session, your sequencer configuration must be valid and your camera must not be streaming.

Set [SequencerMode](#) to On. This locks all sequenced features (direct, implied, fixed, and forced) and loads the starting set.

Start image acquisition. The sequencer transitions from set to set according to your path definitions. [SequencerSetActive](#) displays the current set.

During sequencer execution, all sequenced features (direct, implied, fixed, and forced) are locked as their values are driven by the sequencer. However, you can change any features that are not locked. They behave as per normal operation.

To end the sequencer session, set [SequencerMode](#) to Off. The camera is left in the same state as defined by the last sequencer set.

### 8.1.3 Sequencer Usage Example - Simple features change while acquiring images

In this example, Set 0 and Set 1 are the main sets for the camera to capture images. The directly sequenced features are **Exposure Time, Gain, Width**. Set 0 is defined to acquire full width images with a long exposure and no gain. Set 1 is defined to acquire half-width images with a shorter exposure and higher gain. The transition between the two sets is defined to be triggered by **RisingEdge** of **FrameStart**, meaning that the sequencer should toggle between the two sets grabbing an image based on the feature contents of the corresponding set configuration each time.

Set 0:

- ExposureTime = 4000
- Gain = 1.0
- Width = 1024
- SequencerSetTriggerSource[0] = FrameStart
- SequencerSetTriggerActivation[0] = RisingEdge
- SequencerSetTriggerSource[0] = FrameStart
- SequencerSetNext[0] = 1

Set 1:

- ExposureTime = 2000
- Gain = 2.0
- Width = 512
- SequencerSetTriggerSource[0] = FrameStart
- SequencerSetTriggerActivation[0] = RisingEdge
- SequencerSetTriggerSource[0] = FrameStart
- SequencerSetNext[0] = 0

Sequencer begins execution from Set 0.

The working diagram is shown in the following figure:

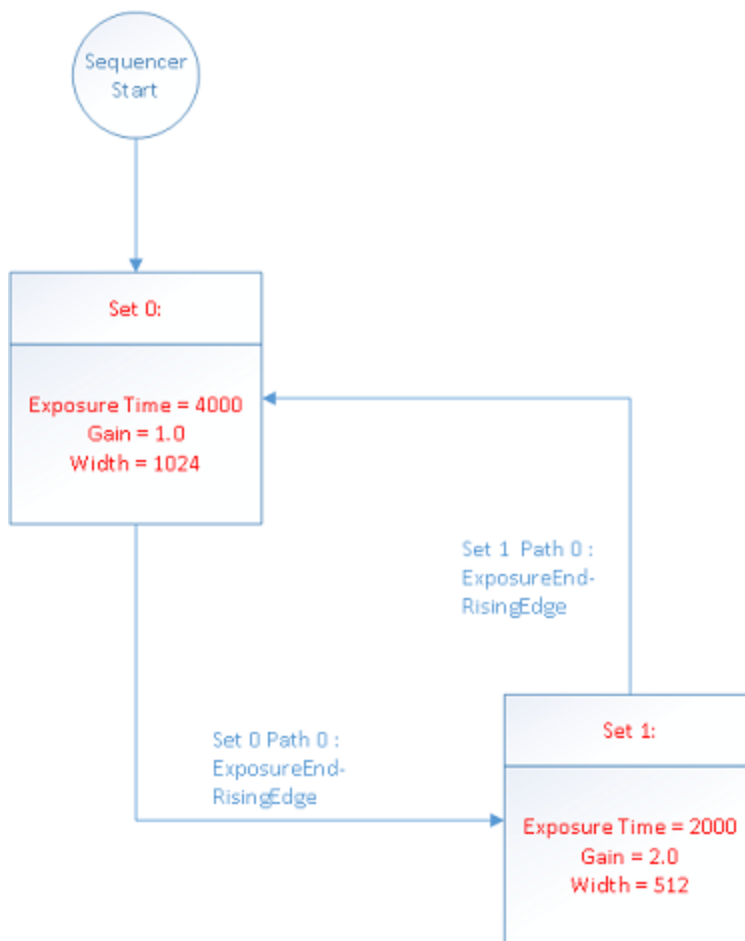

## 8.2 Summary Table

| Name  | Interface    | Access | Visibility | Description   |
|---|--------------|--------|------------|---|
| <a href="#">Sequencer Mode</a>  | IEnumeration | RW     | Expert     | Controls whether or not a sequencer is active.                          |
| <a href="#">Sequencer Configuration Mode</a>                          | IEnumeration | RW     | Expert     | Controls whether or not a sequencer is in configuration mode.           |
| <a href="#">Sequencer Configuration Valid</a>                         | IEnumeration | RO     | Expert     | Display whether the current sequencer configuration is valid to run.    |
| <a href="#">Sequencer Feature Selector</a>                            | IEnumeration | RW     | Expert     | Selects which sequencer features to control.                            |
| <a href="#">Sequencer Feature Enable [Sequencer Feature Selector]</a> | IBoolean     | RW     | Expert     | Enables the selected feature and makes it active in all sequencer sets. |
| <a href="#">Sequencer Set Start</a>                                   | Integer      | RW     | Expert     | Sets the first sequencer set to be used.                                |
| <a href="#">Sequencer Set Active</a>                                  | Integer      | RO     | Expert     | Displays the currently active sequencer                                 |

| Name  | Interface    | Access | Visibility | Description  |
|---|--------------|--------|------------|--|
|   |              |        |            | set.   |
| <a href="#">Sequencer Set Selector</a>  | Integer      | RW     | Expert     | Selects the sequencer set to which subsequent settings apply.                                |
| <a href="#">Sequencer Set Valid</a> [ <a href="#">Sequencer Set Selector</a> ]  | IEnumeration | RO     | Expert     | Displays whether the currently selected sequencer set's register contents are valid to use.  |
| <a href="#">Sequencer Set Save</a> [ <a href="#">Sequencer Set Selector</a> ]   | ICommand     | RW     | Expert     | Saves the current device configuration to the currently selected sequencer set.              |
| <a href="#">Sequencer Set Load</a> [ <a href="#">Sequencer Set Selector</a> ]   | ICommand     | RW     | Expert     | Loads currently selected sequencer to the current device configuration.                      |
| <a href="#">Sequencer Path Selector</a> [ <a href="#">Sequencer Set Selector</a> ]  | Integer      | RW     | Expert     | Selects branching path to be used for subsequent settings.                                   |
| <a href="#">Sequencer Trigger Source</a> [ <a href="#">Sequencer Set Selector</a> ] [ <a href="#">Sequencer Path Selector</a> ]     | IEnumeration | RW     | Expert     | Specifies the internal signal or physical input line to use as the sequencer trigger source. |
| <a href="#">Sequencer Trigger Activation</a> [ <a href="#">Sequencer Set Selector</a> ] [ <a href="#">Sequencer Path Selector</a> ] | IEnumeration | RW     | Expert     | Specifies the activation mode of the sequencer trigger.                                      |
| <a href="#">Sequencer Set Next</a> [ <a href="#">Sequencer Set Selector</a> ] [ <a href="#">Sequencer Path Selector</a> ]           | Integer      | RW     | Expert     | Specifies the next sequencer set.  |

## 8.3 Sequencer Control Features

### 8.3.1 Sequencer Mode

Controls whether or not a sequencer is active.

| Property          | Value         |
|-------------------|---------------|
| <b>Name</b>       | SequencerMode |
| <b>Interface</b>  | IEnumeration  |
| <b>Access</b>     | RW            |
| <b>Visibility</b> | Expert        |

#### Enumeration Values

Off

On

### 8.3.2 Sequencer Configuration Mode

Controls whether or not a sequencer is in configuration mode.

| Property          | Value                      |
|-------------------|----------------------------|
| <b>Name</b>       | SequencerConfigurationMode |
| <b>Interface</b>  | IEnumeration               |
| <b>Access</b>     | RW                         |
| <b>Visibility</b> | Expert                     |

#### Enumeration Values

Off

On

### 8.3.3 Sequencer Configuration Valid

Display whether the current sequencer configuration is valid to run.

| Property          | Value                       |
|-------------------|-----------------------------|
| <b>Name</b>       | SequencerConfigurationValid |
| <b>Interface</b>  | IEnumeration                |
| <b>Access</b>     | RO                          |
| <b>Visibility</b> | Expert                      |

#### Enumeration Values

No

Yes

### 8.3.4 Sequencer Feature Selector

Selects which sequencer features to control.

| Property          | Value                    |
|-------------------|--------------------------|
| <b>Name</b>       | SequencerFeatureSelector |
| <b>Interface</b>  | IEnumeration             |
| <b>Access</b>     | RW                       |
| <b>Visibility</b> | Expert                   |

#### Enumeration Values

|              |
|--------------|
| ExposureTime |
| Gain         |

### 8.3.5 Sequencer Feature Enable

Enables the selected feature and makes it active in all sequencer sets.

| Property          | Value   |
|-------------------|---|
| <b>Name</b>       | SequencerFeatureEnable <a href="#">[Sequencer Feature Selector]</a> |
| <b>Interface</b>  | IBoolean  |
| <b>Access</b>     | RW  |
| <b>Visibility</b> | Expert  |

### 8.3.6 Sequencer Set Start

Sets the first sequencer set to be used.

| Property          | Value             |
|-------------------|-------------------|
| <b>Name</b>       | SequencerSetStart |
| <b>Interface</b>  | IInteger          |
| <b>Access</b>     | RW                |
| <b>Unit</b>       |                   |
| <b>Visibility</b> | Expert            |



### 8.3.7 Sequencer Set Active

Displays the currently active sequencer set.

| Property          | Value              |
|-------------------|--------------------|
| <b>Name</b>       | SequencerSetActive |
| <b>Interface</b>  | Integer            |
| <b>Access</b>     | RO                 |
| <b>Unit</b>       |                    |
| <b>Visibility</b> | Expert             |

### 8.3.8 Sequencer Set Selector

Selects the sequencer set to which subsequent settings apply.

| Property          | Value                |
|-------------------|----------------------|
| <b>Name</b>       | SequencerSetSelector |
| <b>Interface</b>  | Integer              |
| <b>Access</b>     | RW                   |
| <b>Unit</b>       |                      |
| <b>Visibility</b> | Expert               |

### 8.3.9 Sequencer Set Valid

Displays whether the currently selected sequencer set's register contents are valid to use.

| Property          | Value  |
|-------------------|--|
| <b>Name</b>       | SequencerSetValid <a href="#">[Sequencer Set Selector]</a> |
| <b>Interface</b>  | IEnumeration   |
| <b>Access</b>     | RO   |
| <b>Visibility</b> | Expert   |

#### Enumeration Values

No

### Enumeration Values

Yes

## 8.3.10 Sequencer Set Save

Saves the current device configuration to the currently selected sequencer set.

| Property          | Value   |
|-------------------|---|
| <b>Name</b>       | SequencerSetSave <a href="#">[Sequencer Set Selector]</a> |
| <b>Interface</b>  | ICommand  |
| <b>Access</b>     | RW  |
| <b>Visibility</b> | Expert  |

## 8.3.11 Sequencer Set Load

Loads currently selected sequencer to the current device configuration.

| Property          | Value   |
|-------------------|---|
| <b>Name</b>       | SequencerSetLoad <a href="#">[Sequencer Set Selector]</a> |
| <b>Interface</b>  | ICommand  |
| <b>Access</b>     | RW  |
| <b>Visibility</b> | Expert  |

## 8.3.12 Sequencer Path Selector

Selects branching path to be used for subsequent settings.

| Property          | Value  |
|-------------------|--|
| <b>Name</b>       | SequencerPathSelector <a href="#">[Sequencer Set Selector]</a> |
| <b>Interface</b>  | Integer  |
| <b>Access</b>     | RW   |
| <b>Unit</b>       |  |
| <b>Visibility</b> | Expert   |

### 8.3.13 Sequencer Trigger Source

Specifies the internal signal or physical input line to use as the sequencer trigger source.

| Property          | Value   |
|-------------------|---|
| <b>Name</b>       | SequencerTriggerSource <a href="#">[Sequencer Set Selector]</a> <a href="#">[Sequencer Path Selector]</a> |
| <b>Interface</b>  | IEnumeration  |
| <b>Access</b>     | RW  |
| <b>Visibility</b> | Expert  |

#### Enumeration Values

|            |
|------------|
| Off        |
| FrameStart |

### 8.3.14 Sequencer Trigger Activation

Specifies the activation mode of the sequencer trigger.

| Property          | Value   |
|-------------------|---|
| <b>Name</b>       | SequencerTriggerActivation <a href="#">[Sequencer Set Selector]</a> <a href="#">[Sequencer Path Selector]</a> |
| <b>Interface</b>  | IEnumeration  |
| <b>Access</b>     | RW  |
| <b>Visibility</b> | Expert  |

#### Enumeration Values

|             |
|-------------|
| RisingEdge  |
| FallingEdge |
| AnyEdge     |
| LevelHigh   |
| LevelLow    |

### 8.3.15 Sequencer Set Next

Specifies the next sequencer set.

| Property          | Value   |
|-------------------|---|
| <b>Name</b>       | SequencerSetNext <a href="#">[Sequencer Set Selector]</a> <a href="#">[Sequencer Path Selector]</a> |
| <b>Interface</b>  | Integer   |
| <b>Access</b>     | RW  |
| <b>Unit</b>       |   |
| <b>Visibility</b> | Expert  |

# 9 Color Transformation Control

**NOTE:** To access color transformation controls, ISP must be enabled. The ISP enable feature is under the Image Format control (IspEnable). Color transformation is only available on standard color models. It is not available on polarized color models.

A color transformation is a linear operation applied to input red, green, and blue values for each pixel, which are multiplied by a 3x3 matrix and then added to an offset triplet.

The equation, taking input RGB values and producing three output channels (C0, C1 and C2) is given by:

$$\begin{bmatrix} C0_{out} \\ C1_{out} \\ C2_{out} \end{bmatrix} = \begin{bmatrix} Gain00 & Gain01 & Gain02 \\ Gain10 & Gain11 & Gain12 \\ Gain20 & Gain21 & Gain22 \end{bmatrix} \begin{bmatrix} R_{in} \\ G_{in} \\ B_{in} \end{bmatrix} + \begin{bmatrix} Offset0 \\ Offset1 \\ Offset2 \end{bmatrix}$$

There are two available color transformations, **RGB to RGB** and **RGB to YUV**.

The **RGB to RGB** transform takes input in the camera's native RGB color space, which varies based on the properties of the camera and sensor. The RGB to RGB transform is usually used to convert from the camera's native color space to sRGB (standard RGB) color space. This operation is often called a Color Correction Matrix (CCM).

The RGB to RGB transform can be enabled/disabled. Select RGB to RGB with [Color Transformation Selector](#) and then set [Color Transformation Enable](#) to 0 (disabled) or 1 (enabled).

Use the [RGB Transform Light Source](#) to select the active RGB to RGB matrix from a set of pre-calibrated matrices optimized for different lighting conditions.

To set your own RGB to RGB matrix, select Custom [RGB Transform Light Source](#), and then use the features [Color Transformation Value Selector](#) and [Color Transformation Value](#) to set the Gain/Offset coefficients.

The **RGB to YUV** transform happens after the RGBtoRGB transform and after applying [Gamma](#). It is only available for YUV or YCbCr pixel formats, and it cannot be enabled or disabled, except by changing [Pixel Format](#).

For both RGB to RGB and RGB to YUV, the gain/offset values used can be queried by selecting a value with Color Transformation Value Selector and then reading its Color Transformation Value.

In addition to the RGB to RGB transform, the color of the image can also be adjusted with the [Saturation](#) control, when [Saturation Enable](#) is set to 1. Increasing [Saturation](#) makes the colors in the image more vivid.

## 9.1 Summary Table

| Name  | Interface    | Access | Visibility | Description  |
|---|--------------|--------|------------|--|
| <a href="#">Color Transformation Selector</a> | IEnumeration |        | Beginner   | Selects which Color Transformation module is controlled by the various Color Transformation features |
| <a href="#">Color Transformation</a>          | IBoolean     |        | Beginner   | Enables/disables the color transform selected with   |

| Name   | Interface    | Access | Visibility | Description  |
|--|--------------|--------|------------|--|
| <a href="#">Enable [Color Transformation Selector]</a>   |              |        |            | ColorTransformationSelector. For RGB to YUV this is read-only. Enabling/disabling RGB to YUV can only be done by changing pixel format.  |
| <a href="#">Color Transformation Value Selector [Color Transformation Selector]</a>                              | IEnumeration |        |            | Selects the Gain factor or Offset of the Transformation matrix to access in the selected Color Transformation module   |
| <a href="#">Color Transformation Value [Color Transformation Selector] [Color Transformation Value Selector]</a> | IFloat       |        |            | Represents the value of the selected Gain factor or Offset inside the Transformation matrix in floating point precision.   |
| <a href="#">RGB Transform Light Source</a>   | IEnumeration |        | Expert     | Used to select from a set of RGBtoRGB transform matrices calibrated for different light sources. Selecting a value also sets the white balance ratios (BalanceRatioRed and BalanceRatioBlue), but those can be overwritten through manual or auto white balance. |
| <a href="#">Saturation Enable</a>  | IBoolean     |        | Beginner   | Enables/disables Saturation adjustment.  |
| <a href="#">Saturation</a>   | IFloat       |        | Beginner   | Controls the color saturation.   |

## 9.2 Color Transformation Control Features

### 9.2.1 Color Transformation Selector

Selects which Color Transformation module is controlled by the various Color Transformation features

| Property          | Value                       |
|-------------------|-----------------------------|
| <b>Name</b>       | ColorTransformationSelector |
| <b>Interface</b>  | IEnumeration                |
| <b>Access</b>     |                             |
| <b>Visibility</b> | Beginner                    |

**Enumeration Values**

RGBtoRGB

RGBtoYUV

## 9.2.2 Color Transformation Enable

Enables/disables the color transform selected with ColorTransformationSelector. For RGB to YUV this is read-only. Enabling/disabling RGB to YUV can only be done by changing pixel format.

| Property          | Value   |
|-------------------|---|
| <b>Name</b>       | ColorTransformationEnable <a href="#">[Color Transformation Selector]</a> |
| <b>Interface</b>  | IBoolean  |
| <b>Access</b>     |   |
| <b>Visibility</b> | Beginner  |

## 9.2.3 Color Transformation Value Selector

Selects the Gain factor or Offset of the Transformation matrix to access in the selected Color Transformation module

| Property          | Value  |
|-------------------|--|
| <b>Name</b>       | ColorTransformationValueSelector <a href="#">[Color Transformation Selector]</a> |
| <b>Interface</b>  | IEnumeration   |
| <b>Access</b>     |  |
| <b>Visibility</b> |  |

**Enumeration Values**

Gain00

Gain01

Gain02

Gain10

Gain11

Gain12

**Enumeration Values**

|         |
|---------|
| Gain20  |
| Gain21  |
| Gain22  |
| Offset0 |
| Offset1 |
| Offset2 |

## 9.2.4 Color Transformation Value

Represents the value of the selected Gain factor or Offset inside the Transformation matrix in floating point precision.

| Property          | Value  |
|-------------------|--|
| <b>Name</b>       | ColorTransformationValue <a href="#">[Color Transformation Selector]</a> <a href="#">[Color Transformation Value Selector]</a> |
| <b>Interface</b>  | IFloat   |
| <b>Access</b>     |  |
| <b>Unit</b>       |  |
| <b>Visibility</b> |  |

## 9.2.5 RGB Transform Light Source

Used to select from a set of RGBtoRGB transform matrices calibrated for different light sources. Selecting a value also sets the white balance ratios (BalanceRatioRed and BalanceRatioBlue), but those can be overwritten through manual or auto white balance.

| Property          | Value                   |
|-------------------|-------------------------|
| <b>Name</b>       | RgbTransformLightSource |
| <b>Interface</b>  | IEnumeration            |
| <b>Access</b>     |                         |
| <b>Visibility</b> | Expert                  |



### Enumeration Values

|                      |
|----------------------|
| General              |
| Tungsten2800K        |
| WarmFluorescent3000K |
| CoolFluorescent4000K |
| Daylight5000K        |
| Cloudy6500K          |
| Shade8000K           |
| Custom               |

## 9.2.6 Saturation Enable

Enables/disables Saturation adjustment.

| Property          | Value            |
|-------------------|------------------|
| <b>Name</b>       | SaturationEnable |
| <b>Interface</b>  | IBoolean         |
| <b>Access</b>     |                  |
| <b>Visibility</b> | Beginner         |

## 9.2.7 Saturation

Controls the color saturation.

| Property          | Value      |
|-------------------|------------|
| <b>Name</b>       | Saturation |
| <b>Interface</b>  | IFloat     |
| <b>Access</b>     |            |
| <b>Unit</b>       |            |
| <b>Visibility</b> | Beginner   |

# 10 Auto Algorithm Control

## 10.1 Auto Exposure (AE)

Auto exposure (AE) control is designed to automatically determine the exposure time and gain of the camera so that the resulting image looks as bright as expected. In general, the camera supports various auto exposure features, and these features produce different results in the final image. In addition, the camera allows users to control how fast the exposure and gain get settled.

Note that for AE to work, [Exposure Auto](#) and/or [Gain Auto](#) must be set to Once or Continuous.

### 10.1.1 Auto Exposure Features

To enable AE, [Exposure Auto](#) and/or [Gain Auto](#) must be set to Once or Continuous. AE automatically determines the exposure time and/or gain according to the target image average.

The target image average can be manually or automatically controlled.

For **manual** control, set [Target Grey Value Auto](#) to Continuous and then set the desired image average in [Target Grey Value](#). This value is a percentage of the maximum pixel value.

For **automatic** control, set [Target Grey Value Auto](#) to Off. The target image average is then automatically determined according to user-defined AE modes and other AE features.

By default, AE uses the full range of exposure time and/or gain and target grey value, but these can be limited.

[Exposure Time Lower Limit](#) / [Exposure Time Upper Limit](#) - the lower and upper values in microseconds ( $\mu$ s) that the exposure time may reach when exposure is set to Once or Continuous.

[Gain Lower Limit](#) / [Gain Upper Limit](#) - the lower and upper values in decibels (dB) that the gain may reach when gain is set to Once or Continuous.

[Target Grey Value Lower Limit](#) / [Target Grey Value Upper Limit](#) - the lower and upper values in percent (%) that the target image average may reach.

[Auto Exposure Damping](#) controls how fast the exposure and gain get settled. A small damping value may result in the system being unstable. The range is from 0.0 - 1.0. The default value is 0.5.

If both exposure time and gain are set to Once or Continuous AE determines which to adjust first by the [Auto Exposure Control Priority](#).

If **gain** priority is selected, the camera sets the gain to 0 dB, and the exposure is adjusted according to the target grey level. If the maximum exposure is reached before the target grey level is hit, the gain starts to change to meet the target. This mode is used to have the minimum noise.

If **exposure** priority is selected, the camera sets the exposure to a small value (default is 5 ms). The gain is adjusted according to the target grey level. If maximum gain is reached before the target grey level is hit, the exposure starts to change to meet the target. This mode is used to capture fast motion.

**AE Lighting Mode** can compensate for strong light sources in front or behind an object. The options are: Backlight, Frontlight, or Normal. The default lighting mode is Normal. Use the [Lighting Mode](#) feature to select depending on your conditions.

### 10.1.1.1 Backlight Compensation

The backlight compensation mode is used when a strong light is coming from the back of the object. For example, people standing in the shade with the bright sky at the back. A regular auto exposure algorithm makes the object underexposed in such lighting conditions. Backlight compensation is able to properly expose the object when a strong backlight occurs, regardless of the locations of the object relative to the frame.

### 10.1.1.2 Excessive Frontlight Compensation

The excessive frontlight compensation mode is used when a strong light is shining in the front of the object while the background is dark. For example, a parking spot that has lights on at night while its surrounding areas are very dark. A regular auto exposure algorithm makes the object overexposed in such lighting conditions. Frontlight compensation is able to properly expose the object when a strong front light and a dark background appear, regardless of the locations of the object relative to the frame.

### 10.1.1.3 Normal Lighting

If the object of interest in the frame is not under backlight or frontlight conditions, then normal lighting should be used. Select Normal lighting mode to make Metering Mode available.

**AE Metering Mode** is available only if [Lighting Mode](#) is set to Normal. The options are: Average, Spot, and Partial. The default AE metering mode is Average. Use the [Metering Mode](#) feature to select depending on your conditions.

### 10.1.1.4 Average Metering

This mode measures the light from the entire scene uniformly to determine the final exposure value. Every portion of the exposed area has the same contribution.

### 10.1.1.5 Spot Metering

This mode measures the light from a small area (about 3%) in the center of the scene while the rest of the scene is ignored. This mode is used when the scene has a high contrast and the object of interest is relatively small.

### 10.1.1.6 Partial Metering

This mode measures the light from a larger area (about 11%) in the center of the scene. This mode is used when very dark or bright regions appear at the edge of the frame.

A **region of interest** (ROI) can be applied to the auto exposure features. This AE ROI can be equal to or smaller than the area of the captured ROI. To use AE ROI:

1. Set the [ROI Selector](#) to Auto Exposure.
2. Turn on [ROI Enable](#).
3. Set the horizontal and vertical offsets (relative to the ROI being captured) with [ROI Offset X](#) and [ROI Offset Y](#).
4. Set the width and height with [ROI Width](#) and [ROI Height](#).

[EV Compensation](#) allows you to adjust the resultant image intensity with one control. Positive EV compensation makes the image brighter while negative EV compensation makes the image darker. The range is from -3 to 3 with a step of 1/3. The default value is 0.

## 10.2 Auto White Balance - Color Models

When [White Balance Auto](#) is set to Continuous or Once the camera automatically adjusts the values of [Balance Ratio](#) Red and Blue to achieve good color balance. It is used to compensate for color shifts in the image caused by different lighting conditions.

There are two profiles of auto white balance: Indoor and Outdoor. These are selected with [White Balance Auto Profile](#).

In the **Outdoor** profile, the values of the red and blue balance ratios are restricted to a set of expected values for normal outdoor lighting conditions (i.e., daylight).

In the **Indoor** profile, the values of the red and blue balance ratios can take any values within specified limits. This allows auto white balance to compensate for artificial lighting such as fluorescent lights that are more greenish than daylight. The Indoor profile can also be used for outdoor conditions, since it does not place restrictions on the white balance solution.

By default, auto white balance uses the full range of balance ratios, but these can be limited.

- [White Balance Auto Lower Limit](#) / [White Balance Auto Upper Limit](#) - the lower and upper values that auto white balance can set for the red and blue balance ratios.

[White Balance Auto Damping](#) controls the speed at which auto white balance adjusts the values of the red and blue balance ratios. The range is from 0 to 1. Higher values of damping result in the white balance changing more gradually.

By default auto white balance examines all of the pixels in the image, but it can also use a region of interest (ROI). A common use for an auto white balance ROI is placing a white object in the image and then specifying the ROI on that object. To use ROI:

1. Set the [ROI Selector](#) to Auto White Balance.
2. Turn on [ROI Enable](#).
3. Set the horizontal and vertical offsets (relative to the ROI being captured) with [ROI Offset X](#) and [ROI Offset Y](#).
4. Set the width and height with [ROI Width](#) and [ROI Height](#).

## 10.3 Summary Table

| Name   | Interface    | Access | Visibility | Description   |
|--|--------------|--------|------------|---|
| <a href="#">ROI Selector</a>                                 | IEnumeration |        | Beginner   | Selects which Auto Algorithm is controlled by the RoiEnable, OffsetX, OffsetY, Width, Height features.                            |
| <a href="#">ROI Enable</a><br><a href="#">[ROI Selector]</a> | IBoolean     |        | Guru       | Controls whether a user-specified ROI is used for auto algorithm that is currently selected by the AutoAlgorithmSelector feature. |
| <a href="#">ROI Offset X</a>                                 | IInteger     |        | Guru       | Controls the x-offset of the ROI used by the auto algorithm that  |

| Name   | Interface   | Access | Visibility | Description   |
|--|-------------|--------|------------|---|
| <a href="#">[ROI Selector]</a>                                 |             |        |            | is currently selected by the AutoAlgorithmSelector feature.   |
| <a href="#">ROI Offset Y</a><br><a href="#">[ROI Selector]</a> | Integer     |        | Guru       | Controls the y-offset of the ROI used by the auto algorithm that is currently selected by the AutoAlgorithmSelector feature.  |
| <a href="#">ROI Width</a><br><a href="#">[ROI Selector]</a>    | Integer     |        | Guru       | Controls the width of the ROI used by the auto algorithm that is currently selected by the AutoAlgorithmSelector feature.   |
| <a href="#">ROI Height</a><br><a href="#">[ROI Selector]</a>   | Integer     |        | Guru       | Controls the width of the ROI used by the auto algorithm that is currently selected by the AutoAlgorithmSelector feature.   |
| <a href="#">White Balance Auto Profile</a>                     | Enumeration | RW     | Expert     | Selects the profile used by BalanceWhiteAuto.   |
| <a href="#">White Balance Auto Lower Limit</a>                 | IFloat      |        | Expert     | Controls the minimum value Auto White Balance can set for the Red/Blue BalanceRatio.  |
| <a href="#">White Balance Auto Upper Limit</a>                 | IFloat      |        | Expert     | Controls the maximum value Auto White Balance can set the Red/Blue BalanceRatio.  |
| <a href="#">White Balance Auto Damping</a>                     | IFloat      |        | Expert     | Controls how quickly 'BalanceWhiteAuto' adjusts the values for Red and Blue BalanceRatio in response to changing conditions. Higher damping means the changes are more gradual.   |
| <a href="#">Target Grey Value Auto</a>                         | Enumeration |        | Beginner   | This indicates whether the target image grey level is automatically set by the camera or manually set by the user. Note that the target grey level is in the linear domain before gamma correction is applied.  |
| <a href="#">Target Grey Value</a>                              | IFloat      | RW     |            | This is the user-specified target grey level (image mean) to apply to the current image. Note that the target grey level is in the linear domain before gamma correction is applied.  |
| <a href="#">Lighting Mode</a>                                  | Enumeration | RW     | Beginner   | Selects a lighting mode: Backlight, Frontlight or Normal (default). a. Backlight compensation: used when a strong light is coming from the back of the object. b. Frontlight compensation: used when a strong light is shining in the front of the object while the background is dark. c. Normal lighting: used when the object is not under backlight or frontlight conditions. When normal lighting is selected, metering modes are available. |
| <a href="#">Metering Mode</a>                                  | Enumeration | RW     | Beginner   | Selects a metering mode: average, spot, or partial metering. a. Average: Measures the light from the entire scene uniformly to determine the final exposure value. Every portion of the exposed area has the same contribution. b. Spot: Measures a small area (about 3%) in the center of the scene while the rest   |

| Name   | Interface    | Access | Visibility | Description  |
|--|--------------|--------|------------|--|
|  |              |        |            | of the scene is ignored. This mode is used when the scene has a high contrast and the object of interest is relatively small. c. Partial: Measures the light from a larger area (about 11%) in the center of the scene. This mode is used when very dark or bright regions appear at the edge of the frame. Note: Metering mode is available only when Lighting Mode Selector is Normal.   |
| <a href="#">Exposure Time Lower Limit</a>      | IFloat       | RW     |            | The smallest exposure time that auto exposure can set.   |
| <a href="#">Exposure Time Upper Limit</a>      | IFloat       | RW     |            | The largest exposure time that auto exposure can set.  |
| <a href="#">Gain Lower Limit</a>               | IFloat       | RW     |            | The smallest gain that auto exposure can set.  |
| <a href="#">Gain Upper Limit</a>               | IFloat       | RW     |            | The largest gain that auto exposure can set.   |
| <a href="#">Target Grey Value Lower Limit</a>  | IFloat       | RW     |            | The lowest value in percentage that the target mean may reach.   |
| <a href="#">Target Grey Value Upper Limit</a>  | IFloat       | RW     |            | The highest value in percentage that the target mean may reach.  |
| <a href="#">EV Compensation</a>                | IFloat       | RW     | Beginner   | The EV compensation value used in the exposure compensation. This allows you to adjust the resultant image intensity with one control. A positive value makes the image brighter. A negative value makes the image darker. Range from -3 to 3 with a step of 1/3. Default = 0.   |
| <a href="#">Auto Exposure Damping</a>          | IFloat       | RW     | Beginner   | It controls how fast the exposure and gain get settled. If the value is too small, it may cause the system to be unstable. Range is from 0.0 to 1.0. Default = 0.2.  |
| <a href="#">Auto Exposure Control Priority</a> | IEnumeration | RW     | Beginner   | Selects whether to adjust gain or exposure first. When gain priority is selected, the camera fixes the gain to 0 dB, and the exposure is adjusted according to the target grey level. If the maximum exposure is reached before the target grey level is hit, the gain starts to change to meet the target. This mode is used to have the minimum noise. When exposure priority is selected, the camera sets the exposure to a small value (default is 5 ms). The gain is adjusted according to the target |

| Name | Interface | Access | Visibility | Description   |
|------|-----------|--------|------------|---|
|      |           |        |            | grey level. If maximum gain is reached before the target grey level is hit, the exposure starts to change to meet the target. This mode is used to capture fast motion. |

## 10.4 Auto Algorithm Control Features

### 10.4.1 ROI Selector

Selects which Auto Algorithm is controlled by the RoiEnable, OffsetX, OffsetY, Width, Height features.

| Property          | Value                 |
|-------------------|-----------------------|
| <b>Name</b>       | AutoAlgorithmSelector |
| <b>Interface</b>  | IEnumeration          |
| <b>Access</b>     |                       |
| <b>Visibility</b> | Beginner              |

#### Enumeration Values

|            |
|------------|
| <b>Awb</b> |
| <b>Ae</b>  |

### 10.4.2 ROI Enable

Controls whether a user-specified ROI is used for auto algorithm that is currently selected by the AutoAlgorithmSelector feature.

| Property          | Value                                       |
|-------------------|---|
| <b>Name</b>       | AasRoiEnable <a href="#">[ROI Selector]</a> |
| <b>Interface</b>  | IBoolean                                    |
| <b>Access</b>     |   |
| <b>Visibility</b> | Guru  |

### 10.4.3 ROI Offset X

Controls the x-offset of the ROI used by the auto algorithm that is currently selected by the AutoAlgorithmSelector feature.

| Property          | Value  |
|-------------------|--|
| <b>Name</b>       | AasRoiOffsetX <a href="#">[ROI Selector]</a> |
| <b>Interface</b>  | Integer                                      |
| <b>Access</b>     |  |
| <b>Unit</b>       |  |
| <b>Visibility</b> | Guru   |

### 10.4.4 ROI Offset Y

Controls the y-offset of the ROI used by the auto algorithm that is currently selected by the AutoAlgorithmSelector feature.

| Property          | Value  |
|-------------------|--|
| <b>Name</b>       | AasRoiOffsetY <a href="#">[ROI Selector]</a> |
| <b>Interface</b>  | Integer                                      |
| <b>Access</b>     |  |
| <b>Unit</b>       |  |
| <b>Visibility</b> | Guru   |

### 10.4.5 ROI Width

Controls the width of the ROI used by the auto algorithm that is currently selected by the AutoAlgorithmSelector feature.

| Property          | Value                                      |
|-------------------|--|
| <b>Name</b>       | AasRoiWidth <a href="#">[ROI Selector]</a> |
| <b>Interface</b>  | Integer                                    |
| <b>Access</b>     |  |
| <b>Unit</b>       |  |
| <b>Visibility</b> | Guru                                       |



## 10.4.6 ROI Height

Controls the width of the ROI used by the auto algorithm that is currently selected by the AutoAlgorithmSelector feature.

| Property          | Value                                       |
|-------------------|---|
| <b>Name</b>       | AasRoiHeight <a href="#">[ROI Selector]</a> |
| <b>Interface</b>  | Integer                                     |
| <b>Access</b>     |   |
| <b>Unit</b>       |   |
| <b>Visibility</b> | Guru  |

## 10.4.7 White Balance Auto Profile

Selects the profile used by BalanceWhiteAuto.

| Property          | Value                   |
|-------------------|-------------------------|
| <b>Name</b>       | BalanceWhiteAutoProfile |
| <b>Interface</b>  | IEnumeration            |
| <b>Access</b>     | RW                      |
| <b>Visibility</b> | Expert                  |

### Enumeration Values

|         |
|---------|
| Indoor  |
| Outdoor |

## 10.4.8 White Balance Auto Lower Limit

Controls the minimum value Auto White Balance can set for the Red/Blue BalanceRatio.

| Property         | Value                      |
|------------------|----------------------------|
| <b>Name</b>      | BalanceWhiteAutoLowerLimit |
| <b>Interface</b> | IFloat                     |
| <b>Access</b>    |                            |

| Property   | Value  |
|------------|--------|
| Unit       |        |
| Visibility | Expert |

### 10.4.9 White Balance Auto Upper Limit

Controls the maximum value Auto White Balance can set the Red/Blue BalanceRatio.

| Property   | Value                      |
|------------|----------------------------|
| Name       | BalanceWhiteAutoUpperLimit |
| Interface  | IFloat                     |
| Access     |                            |
| Unit       |                            |
| Visibility | Expert                     |

### 10.4.10 White Balance Auto Damping

Controls how quickly 'BalanceWhiteAuto' adjusts the values for Red and Blue BalanceRatio in response to changing conditions. Higher damping means the changes are more gradual.

| Property   | Value                   |
|------------|-------------------------|
| Name       | BalanceWhiteAutoDamping |
| Interface  | IFloat                  |
| Access     |                         |
| Unit       |                         |
| Visibility | Expert                  |

### 10.4.11 Target Grey Value Auto

This indicates whether the target image grey level is automatically set by the camera or manually set by the user. Note that the target grey level is in the linear domain before gamma correction is applied.

| Property | Value                           |
|----------|---------------------------------|
| Name     | AutoExposureTargetGreyValueAuto |

| Property          | Value        |
|-------------------|--------------|
| <b>Interface</b>  | IEnumeration |
| <b>Access</b>     |              |
| <b>Visibility</b> | Beginner     |

#### Enumeration Values

|                   |
|-------------------|
| <b>Off</b>        |
| <b>Continuous</b> |

### 10.4.12 Target Grey Value

This is the user-specified target grey level (image mean) to apply to the current image. Note that the target grey level is in the linear domain before gamma correction is applied.

| Property          | Value                       |
|-------------------|-----------------------------|
| <b>Name</b>       | AutoExposureTargetGreyValue |
| <b>Interface</b>  | IFloat                      |
| <b>Access</b>     | RW                          |
| <b>Unit</b>       | %                           |
| <b>Visibility</b> |                             |

### 10.4.13 Lighting Mode

Selects a lighting mode: Backlight, Frontlight or Normal (default). a. Backlight compensation: used when a strong light is coming from the back of the object. b. Frontlight compensation: used when a strong light is shining in the front of the object while the background is dark. c. Normal lighting: used when the object is not under backlight or frontlight conditions. When normal lighting is selected, metering modes are available.

| Property          | Value                    |
|-------------------|--------------------------|
| <b>Name</b>       | AutoExposureLightingMode |
| <b>Interface</b>  | IEnumeration             |
| <b>Access</b>     | RW                       |
| <b>Visibility</b> | Beginner                 |

#### Enumeration Values

|            |
|------------|
| AutoDetect |
| Backlight  |
| Frontlight |
| Normal     |

### 10.4.14 Metering Mode

Selects a metering mode: average, spot, or partial metering. a. Average: Measures the light from the entire scene uniformly to determine the final exposure value. Every portion of the exposed area has the same contribution. b. Spot: Measures a small area (about 3%) in the center of the scene while the rest of the scene is ignored. This mode is used when the scene has a high contrast and the object of interest is relatively small. c. Partial: Measures the light from a larger area (about 11%) in the center of the scene. This mode is used when very dark or bright regions appear at the edge of the frame. Note: Metering mode is available only when Lighting Mode Selector is Normal.

| Property | Value |
|----------|-------|
|----------|-------|

|                   |                          |
|-------------------|--------------------------|
| <b>Name</b>       | AutoExposureMeteringMode |
| <b>Interface</b>  | IEnumeration             |
| <b>Access</b>     | RW                       |
| <b>Visibility</b> | Beginner                 |

#### Enumeration Values

|                |
|----------------|
| Average        |
| Spot           |
| Partial        |
| CenterWeighted |
| HistogramPeak  |

### 10.4.15 Exposure Time Lower Limit

The smallest exposure time that auto exposure can set.

| Property | Value |
|----------|-------|
|----------|-------|

|             |                                    |
|-------------|------------------------------------|
| <b>Name</b> | AutoExposureExposureTimeLowerLimit |
|-------------|------------------------------------|

| Property          | Value  |
|-------------------|--------|
| <b>Interface</b>  | IFloat |
| <b>Access</b>     | RW     |
| <b>Unit</b>       | us     |
| <b>Visibility</b> |        |

### 10.4.16 Exposure Time Upper Limit

The largest exposure time that auto exposure can set.

| Property          | Value                              |
|-------------------|------------------------------------|
| <b>Name</b>       | AutoExposureExposureTimeUpperLimit |
| <b>Interface</b>  | IFloat                             |
| <b>Access</b>     | RW                                 |
| <b>Unit</b>       | us                                 |
| <b>Visibility</b> |                                    |

### 10.4.17 Gain Lower Limit

The smallest gain that auto exposure can set.

| Property          | Value                      |
|-------------------|----------------------------|
| <b>Name</b>       | AutoExposureGainLowerLimit |
| <b>Interface</b>  | IFloat                     |
| <b>Access</b>     | RW                         |
| <b>Unit</b>       | dB                         |
| <b>Visibility</b> |                            |

### 10.4.18 Gain Upper Limit

The largest gain that auto exposure can set.

| Property          | Value                      |
|-------------------|----------------------------|
| <b>Name</b>       | AutoExposureGainUpperLimit |
| <b>Interface</b>  | IFloat                     |
| <b>Access</b>     | RW                         |
| <b>Unit</b>       | dB                         |
| <b>Visibility</b> |                            |

### 10.4.19 Target Grey Value Lower Limit

The lowest value in percentage that the target mean may reach.

| Property          | Value                           |
|-------------------|---------------------------------|
| <b>Name</b>       | AutoExposureGreyValueLowerLimit |
| <b>Interface</b>  | IFloat                          |
| <b>Access</b>     | RW                              |
| <b>Unit</b>       | %                               |
| <b>Visibility</b> |                                 |

### 10.4.20 Target Grey Value Upper Limit

The highest value in percentage that the target mean may reach.

| Property          | Value                           |
|-------------------|---------------------------------|
| <b>Name</b>       | AutoExposureGreyValueUpperLimit |
| <b>Interface</b>  | IFloat                          |
| <b>Access</b>     | RW                              |
| <b>Unit</b>       | %                               |
| <b>Visibility</b> |                                 |

### 10.4.21 EV Compensation

The EV compensation value used in the exposure compensation. This allows you to adjust the resultant image intensity with one control. A positive value makes the image brighter. A negative value makes the image darker. Range from -3 to 3 with a step of 1/3. Default = 0.

| Property          | Value                      |
|-------------------|----------------------------|
| <b>Name</b>       | AutoExposureEVCompensation |
| <b>Interface</b>  | IFloat                     |
| <b>Access</b>     | RW                         |
| <b>Unit</b>       |                            |
| <b>Visibility</b> | Beginner                   |

### 10.4.22 Auto Exposure Damping

It controls how fast the exposure and gain get settled. If the value is too small, it may cause the system to be unstable. Range is from 0.0 to 1.0. Default = 0.2.

| Property          | Value                          |
|-------------------|--------------------------------|
| <b>Name</b>       | AutoExposureControlLoopDamping |
| <b>Interface</b>  | IFloat                         |
| <b>Access</b>     | RW                             |
| <b>Unit</b>       |                                |
| <b>Visibility</b> | Beginner                       |

### 10.4.23 Auto Exposure Control Priority

Selects whether to adjust gain or exposure first. When gain priority is selected, the camera fixes the gain to 0 dB, and the exposure is adjusted according to the target grey level. If the maximum exposure is reached before the target grey level is hit, the gain starts to change to meet the target. This mode is used to have the minimum noise. When exposure priority is selected, the camera sets the exposure to a small value (default is 5 ms). The gain is adjusted according to the target grey level. If maximum gain is reached before the target grey level is hit, the exposure starts to change to meet the target. This mode is used to capture fast motion.

| Property          | Value                       |
|-------------------|-----------------------------|
| <b>Name</b>       | AutoExposureControlPriority |
| <b>Interface</b>  | IEnumeration                |
| <b>Access</b>     | RW                          |
| <b>Visibility</b> | Beginner                    |

### Enumeration Values

Gain

ExposureTime



# 11 Defective Pixel Correction

The camera supports table-based defective pixel correction, where a list of defective pixel coordinates is specified, and the values of those pixels are replaced based on the values of their neighbors. The camera comes with a list of defective pixels calibrated during manufacturing (the factory default table), but you can update or replace this list.

[Defect Correct Static Enable](#) turns table-based defective pixel correction On or Off.

[Defect Correction Mode](#) controls the method used for replacing the value of pixels within the table. The options are Average or Highlight. Average replaces defective pixels with the average of their neighbors. Highlight is used for debugging purposes and sets pixels within the table to the maximum possible pixel value to highlight them.

## 11.1 Modifying the List of Defective Pixels

[Defect Correct Pixel Count](#) controls the number of defective pixels in the table.

[Defect Table Index](#) selects an individual pixel within the table. This is a zero-based index, so if there are  $N$  pixels in the table, the index range is from 0 to  $N-1$ . [Defect X Coordinate](#) and [Defect Y Coordinate](#) define the (X,Y) coordinates of the defective pixel selected by the index. These values can be changed. These (X,Y) coordinates are relative to the full image ROI, when [Offset X](#) and [Offset Y](#) are both zero.

Changes made to the defective pixel table using these controls do NOT take effect immediately. When you have finished making a series of changes to the table, execute the command [Defect Table Apply](#) for the changes to affect images captured by the camera. This writes the table to volatile memory, so changes are lost if the camera loses power.

[Defect Table Save](#) saves the table to persistent storage within the camera, so that the modified table is loaded whenever the camera boots up. Saving overwrites the existing table stored in memory.

[Defect Table Factory Restore](#) resets the table to its factory default state. This completely overwrites any changes made to the table, both the active table used in images being captured by the camera and the table saved in memory.

Important Note: Because it takes time to download a full defect table, if the camera is streaming when a table is either applied or restored to factory default, the results may appear momentarily corrupted until the complete table is written to the FPGA.

### 11.1.1 Example: Adding a location to the Defective Pixel Table

These steps illustrate how to add a pixel to the table:

1. Set [Offset X](#) and [Offset Y](#) to zero, and [Width](#) and [Height](#) at least large enough so that the defective pixel falls within the image ROI.
2. Note the X and Y coordinates of the defective pixel under these ROI settings.
3. Increase [Defect Correct Pixel Count](#) by 1 to add a new defective pixel to the list.
4. Set [Defect Table Index](#) to the new value of [Defect Correct Pixel Count](#) minus 1, to control the last defective pixel in the table, which is the one that was just added.
5. Set the values of [Defect X Coordinate](#) and [Defect Y Coordinate](#) to the coordinates of the pixel being added.

6. Click [Defect Table Apply](#) to have the change affect images being captured.
7. Use [Defect Table Save](#) to save the modified table so that it is loaded every time the camera boots up.

## 11.2 Summary Table

| Name   | Interface    | Access | Visibility | Description   |
|--|--------------|--------|------------|---|
| <a href="#">Defect Correct Static Enable</a>             | IBoolean     |        | Guru       | Enables/Disables table-based defective pixel correction.  |
| <a href="#">Defect Correction Mode</a>                   | IEnumeration |        | Guru       | Controls the method used for replacing defective pixels.  |
| <a href="#">Defect Table Pixel Count</a>                 | IInteger     |        | Guru       | The number of defective pixel locations in the current table.   |
| <a href="#">Defect Table Index</a>                       | IInteger     |        | Guru       | Controls the offset of the element to access in the defective pixel location table.   |
| <a href="#">Defect X Coordinate [Defect Table Index]</a> | IInteger     |        | Guru       | Returns the X coordinate of the defective pixel at DefectTableIndex within the defective pixel table. Changes made do not take effect in captured images until the command DefectTableApply is written.   |
| <a href="#">Defect Y Coordinate [Defect Table Index]</a> | IInteger     |        | Guru       | Returns the Y coordinate of the defective pixel at DefectTableIndex within the defective pixel table. Changes made do not take effect in captured images until the command DefectTableApply is written.   |
| <a href="#">Defect Table Apply</a>                       | ICommand     | RW     | Guru       | Applies the current defect table, so that any changes made affect images captured by the camera. This writes the table to volatile memory, so changes to the table are lost if the camera loses power. To save the table to non-volatile memory, use DefectTableSave. |
| <a href="#">Defect Table Save</a>                        | ICommand     |        | Guru       | Saves the current defective pixel table non-volatile memory, so that it is preserved when the camera boots up. This overwrites the existing defective pixel table. The new table is loaded whenever the camera powers up.   |
| <a href="#">Defect Table Factory Restore</a>             | ICommand     |        | Guru       | Restores the Defective Pixel Table to its factory default state, which was calibrated during manufacturing. This permanently overwrites any changes made to the defect table.   |

## 11.3 Defective Pixel Correction Features

### 11.3.1 Defect Correct Static Enable

Enables/Disables table-based defective pixel correction.

| Property          | Value                     |
|-------------------|---------------------------|
| <b>Name</b>       | DefectCorrectStaticEnable |
| <b>Interface</b>  | IBoolean                  |
| <b>Access</b>     |                           |
| <b>Visibility</b> | Guru                      |

### 11.3.2 Defect Correction Mode

Controls the method used for replacing defective pixels.

| Property          | Value                |
|-------------------|----------------------|
| <b>Name</b>       | DefectCorrectionMode |
| <b>Interface</b>  | IEnumeration         |
| <b>Access</b>     |                      |
| <b>Visibility</b> | Guru                 |

#### Enumeration Values

|           |
|-----------|
| Average   |
| Highlight |
| Zero      |

### 11.3.3 Defect Table Pixel Count

The number of defective pixel locations in the current table.

| Property         | Value                 |
|------------------|-----------------------|
| <b>Name</b>      | DefectTablePixelCount |
| <b>Interface</b> | Integer               |

| Property          | Value |
|-------------------|-------|
| <b>Access</b>     |       |
| <b>Unit</b>       |       |
| <b>Visibility</b> | Guru  |

### 11.3.4 Defect Table Index

Controls the offset of the element to access in the defective pixel location table.

| Property          | Value            |
|-------------------|------------------|
| <b>Name</b>       | DefectTableIndex |
| <b>Interface</b>  | Integer          |
| <b>Access</b>     |                  |
| <b>Unit</b>       |                  |
| <b>Visibility</b> | Guru             |

### 11.3.5 Defect X Coordinate

Returns the X coordinate of the defective pixel at DefectTableIndex within the defective pixel table. Changes made do not take effect in captured images until the command DefectTableApply is written.

| Property          | Value   |
|-------------------|---|
| <b>Name</b>       | DefectTableCoordinateX <a href="#">[Defect Table Index]</a> |
| <b>Interface</b>  | Integer   |
| <b>Access</b>     |   |
| <b>Unit</b>       |   |
| <b>Visibility</b> | Guru  |

### 11.3.6 Defect Y Coordinate

Returns the Y coordinate of the defective pixel at DefectTableIndex within the defective pixel table. Changes made do not take effect in captured images until the command DefectTableApply is written.

| Property    | Value   |
|-------------|---|
| <b>Name</b> | DefectTableCoordinateY <a href="#">[Defect Table Index]</a> |

| Property          | Value   |
|-------------------|---------|
| <b>Interface</b>  | Integer |
| <b>Access</b>     |         |
| <b>Unit</b>       |         |
| <b>Visibility</b> | Guru    |

### 11.3.7 Defect Table Apply

Applies the current defect table, so that any changes made affect images captured by the camera. This writes the table to volatile memory, so changes to the table are lost if the camera loses power. To save the table to non-volatile memory, use DefectTableSave.

| Property          | Value            |
|-------------------|------------------|
| <b>Name</b>       | DefectTableApply |
| <b>Interface</b>  | ICommand         |
| <b>Access</b>     | RW               |
| <b>Visibility</b> | Guru             |

### 11.3.8 Defect Table Save

Saves the current defective pixel table non-volatile memory, so that it is preserved when the camera boots up. This overwrites the existing defective pixel table. The new table is loaded whenever the camera powers up.

| Property          | Value           |
|-------------------|-----------------|
| <b>Name</b>       | DefectTableSave |
| <b>Interface</b>  | ICommand        |
| <b>Access</b>     |                 |
| <b>Visibility</b> | Guru            |

### 11.3.9 Defect Table Factory Restore

Restores the Defective Pixel Table to its factory default state, which was calibrated during manufacturing. This permanently overwrites any changes made to the defect table.

| Property          | Value                     |
|-------------------|---------------------------|
| <b>Name</b>       | DefectTableFactoryRestore |
| <b>Interface</b>  | ICommand                  |
| <b>Access</b>     |                           |
| <b>Visibility</b> | Guru                      |

# 12 User Set Control

Features in the User Set Control category allow you to save camera settings to non-volatile memory so that they can be restored to a known state at any time (after the camera has been restarted).

## 12.1 Types of User Sets

You can select which user set to configure, save, or load with the [UserSetSelector](#) feature. There are two classes of user sets.

- User-defined settings
- Factory-defined settings. A factory-defined Default user set is always available. It represents a typical use case for the camera.

If the factory-defined settings are not ideal, they can be used as a starting point. From there, only a few features may need to be modified to achieve the desired configuration. The [UserSetSave](#) feature saves the current camera settings so that they can be recreated later. Once saved, these new custom settings can be loaded at any time.

The [UserSetLoad](#) feature loads the specified user set. Note that one can load a set without first saving. In this situation, the user set contents are the factory-defined default settings.

## 12.2 Start-up User Set

The [UserSetDefault](#) feature is used to configure a camera automatically at start-up. This loads the selected user set at start-up time. By default, it applies the factory-defined Default settings. However, you can change it to any user set so that the next time the camera restarts, it comes up with the selected user set.

## 12.3 User Set Managed Features

Due to limited on-board non-volatile memory, not all features are supported by user sets. See [UserSetFeatureSelector](#) for the list of all features that are supported. Features that are not listed are either of single session nature or are managed explicitly via other features, such as [Defect Table Save](#).

## 12.4 User Set Conversion

The exact list of features managed by user sets may change between different versions of firmware. Consequently, there may not be a perfect match between the set of features saved to non-volatile memory and the set of features handled by the current version of firmware. In this situation, the camera performs any necessary conversions on all saved user sets. This happens automatically the first time the camera is restarted after a firmware update. The conversion performed depends on the nature of the feature discrepancy:

- Obsolete features - Saved features that are no longer supported in the current firmware. These features are ignored and removed from all subsequently saved user sets.

- Missing features - Saved user sets do not have features that are supported in the current firmware. These missing feature values are filled in using one of the factory-defined sets. If [UserSetDefault](#) points to a user-defined set, then the missing feature values are copied from the factory-defined Default set.

## 12.5 Summary Table

| Name  | Interface    | Access | Visibility | Description   |
|---|--------------|--------|------------|---|
| <a href="#">User Set Selector</a>                 | IEnumeration | RW     | Beginner   | Selects the feature User Set to load, save or configure.                                      |
| <a href="#">User Set Load [User Set Selector]</a> | ICommand     | RW     | Expert     | Loads the User Set specified by UserSetSelector to the device and makes it active.            |
| <a href="#">User Set Save [User Set Selector]</a> | ICommand     | RW     | Beginner   | Saves the User Set specified by UserSetSelector to the non-volatile memory of the device.     |
| <a href="#">User Set Default</a>                  | IEnumeration | RW     | Beginner   | Selects the feature User Set to load and make active by default when the device is restarted. |
| <a href="#">User Set Feature Selector</a>         | IEnumeration | RW     | Expert     | List of features that are saved to user sets.   |
| <a href="#">User Set Feature Enable</a>           | IBoolean     | RO     | Expert     | Whether or not the selected feature is saved to user sets.                                    |

## 12.6 User Set Control Features

### 12.6.1 User Set Selector

Selects the feature User Set to load, save or configure.

| Property          | Value           |
|-------------------|-----------------|
| <b>Name</b>       | UserSetSelector |
| <b>Interface</b>  | IEnumeration    |
| <b>Access</b>     | RW              |
| <b>Visibility</b> | Beginner        |

#### Enumeration Values

|                 |
|-----------------|
| <b>Default</b>  |
| <b>UserSet0</b> |
| <b>UserSet1</b> |



## 12.6.2 User Set Load

Loads the User Set specified by UserSetSelector to the device and makes it active.

| Property          | Value   |
|-------------------|---|
| <b>Name</b>       | UserSetLoad <a href="#">[User Set Selector]</a> |
| <b>Interface</b>  | ICommand  |
| <b>Access</b>     | RW  |
| <b>Visibility</b> | Expert  |

## 12.6.3 User Set Save

Saves the User Set specified by UserSetSelector to the non-volatile memory of the device.

| Property          | Value   |
|-------------------|---|
| <b>Name</b>       | UserSetSave <a href="#">[User Set Selector]</a> |
| <b>Interface</b>  | ICommand  |
| <b>Access</b>     | RW  |
| <b>Visibility</b> | Beginner  |

## 12.6.4 User Set Default

Selects the feature User Set to load and make active by default when the device is restarted.

| Property          | Value          |
|-------------------|----------------|
| <b>Name</b>       | UserSetDefault |
| <b>Interface</b>  | IEnumeration   |
| <b>Access</b>     | RW             |
| <b>Visibility</b> | Beginner       |

### Enumeration Values

|          |
|----------|
| Default  |
| UserSet0 |
| UserSet1 |

## 12.6.5 User Set Feature Selector

List of features that are saved to user sets.

| Property          | Value                  |
|-------------------|------------------------|
| <b>Name</b>       | UserSetFeatureSelector |
| <b>Interface</b>  | IEnumeration           |
| <b>Access</b>     | RW                     |
| <b>Visibility</b> | Expert                 |

### Enumeration Values

|                                       |
|---------------------------------------|
| <b>AasRoiEnableAe</b>                 |
| <b>AasRoiEnableAwb</b>                |
| <b>AasRoiHeightAe</b>                 |
| <b>AasRoiHeightAwb</b>                |
| <b>AasRoiOffsetXAe</b>                |
| <b>AasRoiOffsetXAwb</b>               |
| <b>AasRoiOffsetYAe</b>                |
| <b>AasRoiOffsetYAwb</b>               |
| <b>AasRoiWidthAe</b>                  |
| <b>AasRoiWidthAwb</b>                 |
| <b>AcquisitionBurstFrameCount</b>     |
| <b>AcquisitionFrameCount</b>          |
| <b>AcquisitionFrameRate</b>           |
| <b>AcquisitionFrameRateEnable</b>     |
| <b>AcquisitionLineRate</b>            |
| <b>AcquisitionMode</b>                |
| <b>AdcBitDepth</b>                    |
| <b>AutoExposureControlLoopDamping</b> |

### Enumeration Values

|   |
|---|
| <b>AutoExposureControlPriority</b>        |
| <b>AutoExposureEVCompensation</b>         |
| <b>AutoExposureExposureTimeLowerLimit</b> |
| <b>AutoExposureExposureTimeUpperLimit</b> |
| <b>AutoExposureGainLowerLimit</b>         |
| <b>AutoExposureGainUpperLimit</b>         |
| <b>AutoExposureGreyValueLowerLimit</b>    |
| <b>AutoExposureGreyValueUpperLimit</b>    |
| <b>AutoExposureLightingMode</b>           |
| <b>AutoExposureMeteringMode</b>           |
| <b>AutoExposureTargetGreyValue</b>        |
| <b>AutoExposureTargetGreyValueAuto</b>    |
| <b>BalanceRatioBlue</b>                   |
| <b>BalanceRatioRed</b>                    |
| <b>BalanceWhiteAuto</b>                   |
| <b>BalanceWhiteAutoDamping</b>            |
| <b>BalanceWhiteAutoLowerLimit</b>         |
| <b>BalanceWhiteAutoProfile</b>            |
| <b>BalanceWhiteAutoUpperLimit</b>         |
| <b>BinningHorizontalAll</b>               |
| <b>BinningHorizontalMode</b>              |
| <b>BinningVerticalAll</b>                 |
| <b>BinningVerticalMode</b>                |
| <b>BlackLevelAll</b>                      |
| <b>ChunkEnableAll</b>                     |
| <b>ChunkModeActive</b>                    |

### Enumeration Values

|   |
|---|
| <b>ColorTransformationEnable</b>        |
| <b>ControlPacketsReservedBandwidth</b>  |
| <b>CounterDelayCounter0</b>             |
| <b>CounterDelayCounter1</b>             |
| <b>CounterDurationCounter0</b>          |
| <b>CounterDurationCounter1</b>          |
| <b>CounterEventActivationCounter0</b>   |
| <b>CounterEventActivationCounter1</b>   |
| <b>CounterEventSourceCounter0</b>       |
| <b>CounterEventSourceCounter1</b>       |
| <b>CounterResetActivationCounter0</b>   |
| <b>CounterResetActivationCounter1</b>   |
| <b>CounterResetSourceCounter0</b>       |
| <b>CounterResetSourceCounter1</b>       |
| <b>CounterTriggerActivationCounter0</b> |
| <b>CounterTriggerActivationCounter1</b> |
| <b>CounterTriggerSourceCounter0</b>     |
| <b>CounterTriggerSourceCounter1</b>     |
| <b>DecimationHorizontalAll</b>          |
| <b>DecimationVerticalAll</b>            |
| <b>DefectCorrectStaticEnable</b>        |
| <b>DefectCorrectionMode</b>             |
| <b>DeviceIndicatorMode</b>              |
| <b>DeviceLinkBandwidthReserve</b>       |
| <b>DeviceLinkThroughputLimit</b>        |
| <b>EvCompensationRaw</b>                |

### Enumeration Values

|   |
|---|
| <b>EventNotificationError</b>             |
| <b>EventNotificationExposureEnd</b>       |
| <b>EventNotificationSerialPortReceive</b> |
| <b>ExposureActiveMode</b>                 |
| <b>ExposureAuto</b>                       |
| <b>ExposureMode</b>                       |
| <b>ExposureTime</b>                       |
| <b>GainAll</b>                            |
| <b>GainAuto</b>                           |
| <b>Gamma</b>                              |
| <b>GammaEnable</b>                        |
| <b>GevSCPD</b>                            |
| <b>GevSCPSBigEndian</b>                   |
| <b>GevSCPSDoNotFragment</b>               |
| <b>GevSCSPPacketSize</b>                  |
| <b>Height</b>                             |
| <b>IspEnable</b>                          |
| <b>LUTEnable</b>                          |
| <b>LineFilterWidthLine0Debounce</b>       |
| <b>LineFilterWidthLine0Deglitch</b>       |
| <b>LineFilterWidthLine1Debounce</b>       |
| <b>LineFilterWidthLine1Deglitch</b>       |
| <b>LineFilterWidthLine2Debounce</b>       |
| <b>LineFilterWidthLine2Deglitch</b>       |
| <b>LineFilterWidthLine3Debounce</b>       |
| <b>LineFilterWidthLine3Deglitch</b>       |

### Enumeration Values

**LineFilterWidthLine4Debounce**

**LineFilterWidthLine4Deglitch**

**LineFilterWidthLine5Debounce**

**LineFilterWidthLine5Deglitch**

**LineFilterWidthLine6Debounce**

**LineFilterWidthLine6Deglitch**

**LineInverterLine0**

**LineInverterLine1**

**LineInverterLine2**

**LineInverterLine3**

**LineInverterLine4**

**LineInverterLine5**

**LineInverterLine6**

**LineModeLine0**

**LineModeLine1**

**LineModeLine2**

**LineModeLine3**

**LineModeLine4**

**LineModeLine5**

**LineModeLine6**

**LineSourceLine0**

**LineSourceLine1**

**LineSourceLine2**

**LineSourceLine3**

**LineSourceLine4**

**LineSourceLine5**

### Enumeration Values

|   |
|---|
| LineSourceLine6                               |
| LogicBlockLUTInputActivationLogicBlock0Input0 |
| LogicBlockLUTInputActivationLogicBlock0Input1 |
| LogicBlockLUTInputActivationLogicBlock0Input2 |
| LogicBlockLUTInputActivationLogicBlock0Input3 |
| LogicBlockLUTInputActivationLogicBlock1Input0 |
| LogicBlockLUTInputActivationLogicBlock1Input1 |
| LogicBlockLUTInputActivationLogicBlock1Input2 |
| LogicBlockLUTInputActivationLogicBlock1Input3 |
| LogicBlockLUTInputSourceLogicBlock0Input0     |
| LogicBlockLUTInputSourceLogicBlock0Input1     |
| LogicBlockLUTInputSourceLogicBlock0Input2     |
| LogicBlockLUTInputSourceLogicBlock0Input3     |
| LogicBlockLUTInputSourceLogicBlock1Input0     |
| LogicBlockLUTInputSourceLogicBlock1Input1     |
| LogicBlockLUTInputSourceLogicBlock1Input2     |
| LogicBlockLUTInputSourceLogicBlock1Input3     |
| LogicBlockLUTOutputValueAllLogicBlock0Enable  |
| LogicBlockLUTOutputValueAllLogicBlock0Value   |
| LogicBlockLUTOutputValueAllLogicBlock1Enable  |
| LogicBlockLUTOutputValueAllLogicBlock1Value   |
| OffsetX                                       |
| OffsetY                                       |
| PixelFormat                                   |
| ReverseX                                      |
| ReverseY                                      |

### Enumeration Values

|                                   |
|-----------------------------------|
| RgbTransformLightSource           |
| Saturation                        |
| SaturationEnable                  |
| SensorShutterMode                 |
| SerialPortBaudRateSerialPort0     |
| SerialPortDataBitsSerialPort0     |
| SerialPortParitySerialPort0       |
| SerialPortSourceSerialPort0       |
| SerialPortStopBitsSerialPort0     |
| Sharpening                        |
| SharpeningAuto                    |
| SharpeningEnable                  |
| SharpeningThreshold               |
| TestPatternPipelineStart          |
| TestPatternSensor                 |
| TransferBlockCount                |
| TransferControlMode               |
| TransferOperationMode             |
| TriggerActivationAcquisitionStart |
| TriggerActivationFrameBurstStart  |
| TriggerActivationFrameStart       |
| TriggerDelayAcquisitionStart      |
| TriggerDelayFrameBurstStart       |
| TriggerDelayFrameStart            |
| TriggerModeAcquisitionStart       |
| TriggerModeFrameBurstStart        |



### Enumeration Values

|                                |
|--------------------------------|
| TriggerModeFrameStart          |
| TriggerOverlapAcquisitionStart |
| TriggerOverlapFrameBurstStart  |
| TriggerOverlapFrameStart       |
| TriggerSourceAcquisitionStart  |
| TriggerSourceFrameBurstStart   |
| TriggerSourceFrameStart        |
| UserOutputValueAll             |
| V3_3EnableLine0                |
| V3_3EnableLine1                |
| V3_3EnableLine2                |
| V3_3EnableLine3                |
| V3_3EnableLine4                |
| V3_3EnableLine5                |
| V3_3EnableLine6                |
| Width                          |

## 12.6.6 User Set Feature Enable

Whether or not the selected feature is saved to user sets.

| Property          | Value                |
|-------------------|----------------------|
| <b>Name</b>       | UserSetFeatureEnable |
| <b>Interface</b>  | IBoolean             |
| <b>Access</b>     | RO                   |
| <b>Visibility</b> | Expert               |

# 13 Chunk Data Control

Chunk Data allows you the ability to send additional information with the image data. This can be helpful when debugging issues or looking at what settings have been applied to the acquired image.

Use [ChunkModeActive](#) to enable chunk data for images.

The following information is available as chunk data:

- Image - enabled by default and cannot be disabled.
- Image CRC - enabled by default and cannot be disabled.
- FrameID
- OffsetX
- OffsetY
- Width
- Height
- Exposure Time
- Gain
- Black Level
- Pixel Format
- ImageTimestamp
- Sequencer Set Active

Use [ChunkSelector](#) to select a chunk then use [ChunkEnable](#) to enable or disable it. Image and ImageCRC cannot be disabled.

Once acquisition has started Chunk data can not be altered. To enable or disable chunks acquisition must be stopped.

## 13.1 Summary Table

| Name  | Interface    | Access | Visibility | Description   |
|---|--------------|--------|------------|---|
| <a href="#">Chunk Mode Active</a>             | IBoolean     | RW     | Expert     | Activates the inclusion of Chunk data in the payload of the image.            |
| <a href="#">Chunk Selector</a>                | IEnumeration | RW     | Expert     | Selects which chunk data to enable or disable.                                |
| <a href="#">Chunk Enable [Chunk Selector]</a> | IBoolean     | RW     | Expert     | Enables the inclusion of the selected Chunk data in the payload of the image. |
| <a href="#">Chunk Image</a>                   | IInteger     | RO     | Expert     | Returns the image payload.  |
| <a href="#">Image CRC</a>                     | IInteger     | RO     | Expert     | Returns the CRC of the image payload.   |

| Name   | Interface   | Access | Visibility | Description   |
|--|-------------|--------|------------|---|
| <a href="#">Chunk Frame ID</a>                                 | Integer     | RO     | Expert     | Returns the image frame ID.   |
| <a href="#">Chunk Offset X</a>                                 | Integer     | RO     | Expert     | Returns the Offset X of the image included in the payload.                            |
| <a href="#">Chunk Offset Y</a>                                 | Integer     | RO     | Expert     | Returns the Offset Y of the image included in the payload.                            |
| <a href="#">Chunk Width</a>                                    | Integer     | RO     | Expert     | Returns the width of the image included in the payload.                               |
| <a href="#">Chunk Height</a>                                   | Integer     | RO     | Expert     | Returns the height of the image included in the payload.                              |
| <a href="#">Chunk Pixel Format</a>                             | Enumeration |        | Expert     | Format of the pixel provided by the camera  |
| <a href="#">Chunk Exposure Time</a>                            | IFloat      | RO     | Expert     | Returns the exposure time used to capture the image.                                  |
| <a href="#">Chunk Gain Selector</a>                            | Enumeration |        | Expert     | Selects which gain to retrieve  |
| <a href="#">Chunk Gain [Chunk Gain Selector]</a>               | IFloat      | RO     | Expert     | Returns the gain used to capture the image.   |
| <a href="#">Chunk Black Level Selector</a>                     | Enumeration |        | Expert     | Selects which black level to retrieve   |
| <a href="#">Chunk Black Level [Chunk Black Level Selector]</a> | IFloat      | RO     | Expert     | Returns the black level used to capture the image.                                    |
| <a href="#">Chunk Timestamp</a>                                | Integer     | RO     | Expert     | Returns the Timestamp of the image.   |
| <a href="#">Chunk Sequencer Set Active</a>                     | Integer     | RO     | Expert     | Returns the index of the active set of the running sequencer included in the payload. |
| <a href="#">Chunk Serial Data Length</a>                       | Integer     | RO     | Expert     | Returns the length of the received serial data that was included in the payload.      |
| <a href="#">Chunk Serial Data</a>                              | IStringReg  |        | Expert     | Returns the serial data that was received.  |
| <a href="#">Chunk Serial Receive Overflow</a>                  | IBoolean    | RO     | Expert     | Returns the status of the chunk serial receive overflow.                              |

## 13.2 Chunk Data Control Features

### 13.2.1 Chunk Mode Active

Activates the inclusion of Chunk data in the payload of the image.

| Property          | Value           |
|-------------------|-----------------|
| <b>Name</b>       | ChunkModeActive |
| <b>Interface</b>  | IBoolean        |
| <b>Access</b>     | RW              |
| <b>Visibility</b> | Expert          |

## 13.2.2 Chunk Selector

Selects which chunk data to enable or disable.

| Property          | Value         |
|-------------------|---------------|
| <b>Name</b>       | ChunkSelector |
| <b>Interface</b>  | IEnumeration  |
| <b>Access</b>     | RW            |
| <b>Visibility</b> | Expert        |

### Enumeration Values

|                     |
|---------------------|
| <b>Image</b>        |
| <b>CRC</b>          |
| <b>FrameID</b>      |
| <b>OffsetX</b>      |
| <b>OffsetY</b>      |
| <b>Width</b>        |
| <b>Height</b>       |
| <b>ExposureTime</b> |
| <b>Gain</b>         |
| <b>BlackLevel</b>   |
| <b>PixelFormat</b>  |
| <b>Timestamp</b>    |

### Enumeration Values

SequencerSetActive

SerialData

## 13.2.3 Chunk Enable

Enables the inclusion of the selected Chunk data in the payload of the image.

| Property          | Value  |
|-------------------|--|
| <b>Name</b>       | ChunkEnable <a href="#">[Chunk Selector]</a> |
| <b>Interface</b>  | IBoolean                                     |
| <b>Access</b>     | RW   |
| <b>Visibility</b> | Expert                                       |

## 13.2.4 Chunk Image

Returns the image payload.

| Property          | Value      |
|-------------------|------------|
| <b>Name</b>       | ChunkImage |
| <b>Interface</b>  | IInteger   |
| <b>Access</b>     | RO         |
| <b>Unit</b>       |            |
| <b>Visibility</b> | Expert     |

## 13.2.5 Image CRC

Returns the CRC of the image payload.

| Property         | Value    |
|------------------|----------|
| <b>Name</b>      | ChunkCRC |
| <b>Interface</b> | IInteger |
| <b>Access</b>    | RO       |

| Property   | Value  |
|------------|--------|
| Unit       |        |
| Visibility | Expert |

### 13.2.6 Chunk Frame ID

Returns the image frame ID.

| Property   | Value        |
|------------|--------------|
| Name       | ChunkFrameID |
| Interface  | Integer      |
| Access     | RO           |
| Unit       |              |
| Visibility | Expert       |

### 13.2.7 Chunk Offset X

Returns the Offset X of the image included in the payload.

| Property   | Value        |
|------------|--------------|
| Name       | ChunkOffsetX |
| Interface  | Integer      |
| Access     | RO           |
| Unit       |              |
| Visibility | Expert       |

### 13.2.8 Chunk Offset Y

Returns the Offset Y of the image included in the payload.

| Property  | Value        |
|-----------|--------------|
| Name      | ChunkOffsetY |
| Interface | Integer      |

| Property          | Value  |
|-------------------|--------|
| <b>Access</b>     | RO     |
| <b>Unit</b>       |        |
| <b>Visibility</b> | Expert |

### 13.2.9 Chunk Width

Returns the width of the image included in the payload.

| Property          | Value      |
|-------------------|------------|
| <b>Name</b>       | ChunkWidth |
| <b>Interface</b>  | Integer    |
| <b>Access</b>     | RO         |
| <b>Unit</b>       |            |
| <b>Visibility</b> | Expert     |

### 13.2.10 Chunk Height

Returns the height of the image included in the payload.

| Property          | Value       |
|-------------------|-------------|
| <b>Name</b>       | ChunkHeight |
| <b>Interface</b>  | Integer     |
| <b>Access</b>     | RO          |
| <b>Unit</b>       |             |
| <b>Visibility</b> | Expert      |

### 13.2.11 Chunk Pixel Format

Format of the pixel provided by the camera

| Property    | Value            |
|-------------|------------------|
| <b>Name</b> | ChunkPixelFormat |

| Property | Value |
|----------|-------|
|----------|-------|

|                   |              |
|-------------------|--------------|
| <b>Interface</b>  | IEnumeration |
| <b>Access</b>     |              |
| <b>Visibility</b> | Expert       |

#### Enumeration Values

|                       |
|-----------------------|
| Mono8                 |
| Mono12Packed          |
| Mono16                |
| RGB8Packed            |
| YUV422Packed          |
| BayerGR8              |
| BayerRG8              |
| BayerGB8              |
| BayerBG8              |
| YCbCr601_422_8_CbYCrY |

## 13.2.12 Chunk Exposure Time

Returns the exposure time used to capture the image.

| Property | Value |
|----------|-------|
|----------|-------|

|                   |                   |
|-------------------|-------------------|
| <b>Name</b>       | ChunkExposureTime |
| <b>Interface</b>  | IFloat            |
| <b>Access</b>     | RO                |
| <b>Unit</b>       | us                |
| <b>Visibility</b> | Expert            |

## 13.2.13 Chunk Gain Selector

Selects which gain to retrieve



| Property          | Value             |
|-------------------|-------------------|
| <b>Name</b>       | ChunkGainSelector |
| <b>Interface</b>  | IEnumeration      |
| <b>Access</b>     |                   |
| <b>Visibility</b> | Expert            |

#### Enumeration Values

|       |
|-------|
| All   |
| Red   |
| Green |
| Blue  |

### 13.2.14 Chunk Gain

Returns the gain used to capture the image.

| Property          | Value   |
|-------------------|---|
| <b>Name</b>       | ChunkGain <a href="#">[Chunk Gain Selector]</a> |
| <b>Interface</b>  | IFloat  |
| <b>Access</b>     | RO  |
| <b>Unit</b>       | dB  |
| <b>Visibility</b> | Expert  |

### 13.2.15 Chunk Black Level Selector

Selects which black level to retrieve

| Property          | Value                   |
|-------------------|-------------------------|
| <b>Name</b>       | ChunkBlackLevelSelector |
| <b>Interface</b>  | IEnumeration            |
| <b>Access</b>     |                         |
| <b>Visibility</b> | Expert                  |

### Enumeration Values

All

## 13.2.16 Chunk Black Level

Returns the black level used to capture the image.

| Property          | Value  |
|-------------------|--|
| <b>Name</b>       | ChunkBlackLevel <a href="#">[Chunk Black Level Selector]</a> |
| <b>Interface</b>  | IFloat   |
| <b>Access</b>     | RO   |
| <b>Unit</b>       | %  |
| <b>Visibility</b> | Expert   |

## 13.2.17 Chunk Timestamp

Returns the Timestamp of the image.

| Property          | Value          |
|-------------------|----------------|
| <b>Name</b>       | ChunkTimestamp |
| <b>Interface</b>  | Integer        |
| <b>Access</b>     | RO             |
| <b>Unit</b>       |                |
| <b>Visibility</b> | Expert         |

## 13.2.18 Chunk Sequencer Set Active

Returns the index of the active set of the running sequencer included in the payload.

| Property         | Value                   |
|------------------|-------------------------|
| <b>Name</b>      | ChunkSequencerSetActive |
| <b>Interface</b> | Integer                 |
| <b>Access</b>    | RO                      |
| <b>Unit</b>      |                         |

| Property   | Value  |
|------------|--------|
| Visibility | Expert |

### 13.2.19 Chunk Serial Data Length

Returns the length of the received serial data that was included in the payload.

| Property   | Value                 |
|------------|-----------------------|
| Name       | ChunkSerialDataLength |
| Interface  | IInteger              |
| Access     | RO                    |
| Unit       |                       |
| Visibility | Expert                |

### 13.2.20 Chunk Serial Data

Returns the serial data that was received.

| Property   | Value           |
|------------|-----------------|
| Name       | ChunkSerialData |
| Interface  | IStringReg      |
| Access     |                 |
| Visibility | Expert          |

### 13.2.21 Chunk Serial Receive Overflow

Returns the status of the chunk serial receive overflow.

| Property   | Value                      |
|------------|----------------------------|
| Name       | ChunkSerialReceiveOverflow |
| Interface  | IBoolean                   |
| Access     | RO                         |
| Visibility | Expert                     |

# 14 LUT Control

Lookup Table (LUT) is a common image processing technique to map a pixel from one value to the other. The camera has an 11-bit input lookup table that produces 9-bit output. When a pixel value is larger than the 11-bit maximum (i.e., 2047), LUT treats it the same as the 2047. The LUT is available for all pixel formats.

- When outputting 8-bit pixel formats, the 9-bit LUT output is rounded down to the 8-bit value.
- When outputting 12-bit pixel formats, the 9-bit LUT output stays as the most significant 9 bits of the 12-bit value and the remaining 3 bits are all zeros.
- When outputting 16-bit pixel formats, the 9-bit LUT output stays as the most significant 9 bits of the 16-bit value and the remaining 7 bits are all zeros.

Therefore, LUT should be used cautiously for 12-bit or 16-bit pixel formats since some of the least significant bits are thrown away.

The factory default LUT is the linear mapping after the camera powers on ( $P' = P/4$ ).

To customize a LUT:

1. Use the [LUT Selector](#) to choose which LUT to control. LUT1 is the only lookup table to allow user access and control.
2. Use [LUT Enable](#) to disable the selected LUT before customizing it. Customizations of the LUT apply immediately, therefore an active LUT that is changed may result in unexpected images.
3. Use [LUT Index](#) to identify the index (offset) of the coefficient to access.
4. [LUT Value](#) returns the value at the entry of the LUT Index. Enter the new value.
5. Repeat steps 3 and 4 as necessary.
6. Enable LUT to have changes take effect.

For coding purposes, [LUT\\_Value\\_All](#) provides access to all the LUT coefficients in a single string without using an individual LUT Index.

Since only one LUT is available for users to access and control, in RGB and YUV pixel formats, the same LUT applies to all three channels (i.e., red, green and blue). In monochrome and Bayer formats, there is a single channel, regardless of the color or monochrome image sensor.

**Note** that the customized LUT is not saved into the camera permanently. After power cycling, the LUT returns to the factory default.

## 14.1 Summary Table

| Name                         | Interface    | Access | Visibility | Description                   |
|------------------------------|--------------|--------|------------|-------------------------------|
| <a href="#">LUT Selector</a> | IEnumeration |        | Expert     | Selects which LUT to control. |

| Name   | Interface | Access | Visibility | Description   |
|--|-----------|--------|------------|---|
| <a href="#">LUT Enable [LUT Selector]</a>            | IBoolean  |        | Expert     | Activates the selected LUT.   |
| <a href="#">LUT Index [LUT Selector]</a>             | IInteger  |        | Guru       | Control the index (offset) of the coefficient to access in the selected LUT.            |
| <a href="#">LUT Value [LUT Selector] [LUT Index]</a> | IInteger  |        | Guru       | Returns the Value at entry LUTIndex of the LUT selected by LUTSelector.                 |
| <a href="#">LUT Value All [LUT Selector]</a>         | IRegister |        | Guru       | Accesses all the LUT coefficients in a single access without using individual LUTIndex. |

## 14.2 LUT Control Features

### 14.2.1 LUT Selector

Selects which LUT to control.

#### Property Value

|                   |              |
|-------------------|--------------|
| <b>Name</b>       | LUTSelector  |
| <b>Interface</b>  | IEnumeration |
| <b>Access</b>     |              |
| <b>Visibility</b> | Expert       |

#### Enumeration Values

LUT1

### 14.2.2 LUT Enable

Activates the selected LUT.

#### Property Value

|                   |  |
|-------------------|--|
| <b>Name</b>       | LUTEnable <a href="#">[LUT Selector]</a> |
| <b>Interface</b>  | IBoolean                                 |
| <b>Access</b>     |  |
| <b>Visibility</b> | Expert                                   |

### 14.2.3 LUT Index

Control the index (offset) of the coefficient to access in the selected LUT.

| Property          | Value                                   |
|-------------------|---|
| <b>Name</b>       | LUTIndex <a href="#">[LUT Selector]</a> |
| <b>Interface</b>  | Integer                                 |
| <b>Access</b>     |   |
| <b>Unit</b>       |   |
| <b>Visibility</b> | Guru                                    |

### 14.2.4 LUT Value

Returns the Value at entry LUTIndex of the LUT selected by LUTSelector.

| Property          | Value   |
|-------------------|---|
| <b>Name</b>       | LUTValue <a href="#">[LUT Selector]</a> <a href="#">[LUT Index]</a> |
| <b>Interface</b>  | Integer   |
| <b>Access</b>     |   |
| <b>Unit</b>       |   |
| <b>Visibility</b> | Guru  |

### 14.2.5 LUT Value All

Accesses all the LUT coefficients in a single access without using individual LUTIndex.

| Property          | Value                                      |
|-------------------|--|
| <b>Name</b>       | LUTValueAll <a href="#">[LUT Selector]</a> |
| <b>Interface</b>  | IRegister                                  |
| <b>Access</b>     |  |
| <b>Visibility</b> | Guru                                       |

# 15 Event Control

## 15.0.1 Event Features

Events allow you to get notified when the camera has performed something you might find interesting. Events are similar to the asynchronous communication but the difference is the initiator is the device.

Once an event is turned on, it has its own XML area where it outputs the event's ID, timestamp, and any applicable event data.

Use [EventSelector](#) to choose an event, then use [EventNotification](#) to set the event On or Off.

The possible events to choose are:

**Exposure End** - Event is sent every image when exposure end occurs. Event data includes: the event ID, timestamp, and frame ID.

**Error** - Event is sent every time an error occurs internally in the device. Event data includes: the event ID, timestamp, frame ID, and error code.

In order to verify that events are working, there is a [TriggerEventTest](#) command which allows you to trigger the camera to send a test event out.

**Event Test** - Event you can trigger to verify events are working properly. This is always enabled. Event data includes: exposure end ID and exposure end timestamp.

## 15.1 Summary Table

| Name  | Interface    | Access | Visibility | Description  |
|---|--------------|--------|------------|--|
| <a href="#">Event Selector</a>                      | IEnumeration | RW     | Expert     | Selects which Event to enable or disable.  |
| <a href="#">Event Notification [Event Selector]</a> | IEnumeration | RW     | Expert     | Enables/Disables the selected event.   |
| <a href="#">Event Exposure End Data</a>             | ICategory    | RO     | Expert     | Category that contains all the data features related to the Exposure End Event.        |
| <a href="#">Event Error Data</a>                    | ICategory    | RO     | Expert     | Category that contains all the data features related to the Error Event.               |
| <a href="#">Event Serial Port Receive Data</a>      | ICategory    | RO     | Expert     | Category that contains all the data features related to the Serial Port Receive Event. |
| <a href="#">Event Test Data</a>                     | ICategory    | RO     | Expert     | Category that contains all the data features related to the Test Event.                |

## 15.2 Event Control Features

## 15.2.1 Event Selector

Selects which Event to enable or disable.

| Property          | Value         |
|-------------------|---------------|
| <b>Name</b>       | EventSelector |
| <b>Interface</b>  | IEnumeration  |
| <b>Access</b>     | RW            |
| <b>Visibility</b> | Expert        |

### Enumeration Values

|                   |
|-------------------|
| Error             |
| ExposureEnd       |
| SerialPortReceive |

## 15.2.2 Event Notification

Enables/Disables the selected event.

| Property          | Value  |
|-------------------|--|
| <b>Name</b>       | EventNotification <a href="#">[Event Selector]</a> |
| <b>Interface</b>  | IEnumeration                                       |
| <b>Access</b>     | RW   |
| <b>Visibility</b> | Expert   |

### Enumeration Values

|     |
|-----|
| On  |
| Off |

## 15.2.3 Event Exposure End Data

Category that contains all the data features related to the Exposure End Event.



| Property          | Value                |
|-------------------|----------------------|
| <b>Name</b>       | EventExposureEndData |
| <b>Interface</b>  | ICategory            |
| <b>Access</b>     | RO                   |
| <b>Visibility</b> | Expert               |

## 15.2.4 Event Error Data

Category that contains all the data features related to the Error Event.

| Property          | Value          |
|-------------------|----------------|
| <b>Name</b>       | EventErrorData |
| <b>Interface</b>  | ICategory      |
| <b>Access</b>     | RO             |
| <b>Visibility</b> | Expert         |

## 15.2.5 Event Serial Port Receive Data

Category that contains all the data features related to the Serial Port Receive Event.

| Property          | Value                      |
|-------------------|----------------------------|
| <b>Name</b>       | EventSerialPortReceiveData |
| <b>Interface</b>  | ICategory                  |
| <b>Access</b>     | RO                         |
| <b>Visibility</b> | Expert                     |

## 15.2.6 Event Test Data

Category that contains all the data features related to the Test Event.

| Property         | Value         |
|------------------|---------------|
| <b>Name</b>      | EventTestData |
| <b>Interface</b> | ICategory     |
| <b>Access</b>    | RO            |

**Property**      **Value**

**Visibility**    Expert

## 15.3 Event Exposure End Data

Category that contains all the data features related to the Exposure End Event.

### 15.3.1 Summary Table

| Name   | Interface | Access | Visibility | Description  |
|--|-----------|--------|------------|--|
| <a href="#">Event Exposure End</a>           | Integer   | RO     | Expert     | Returns the unique identifier of the Exposure End type of Event.                             |
| <a href="#">Event Exposure End Timestamp</a> | Integer   | RO     | Expert     | Returns the Timestamp of the Exposure End Event.   |
| <a href="#">Event Exposure End Frame ID</a>  | Integer   | RO     | Expert     | Returns the unique Identifier of the Frame (or image) that generated the Exposure End Event. |

### 15.3.2 Event Exposure End Data Features

#### 15.3.2.1 Event Exposure End

Returns the unique identifier of the Exposure End type of Event.

**Property**      **Value**

|                   |                  |
|-------------------|------------------|
| <b>Name</b>       | EventExposureEnd |
| <b>Interface</b>  | Integer          |
| <b>Access</b>     | RO               |
| <b>Unit</b>       |                  |
| <b>Visibility</b> | Expert           |
| <b>Value</b>      | 0x9C43           |

#### 15.3.2.2 Event Exposure End Timestamp

Returns the Timestamp of the Exposure End Event.

| Property          | Value                     |
|-------------------|---------------------------|
| <b>Name</b>       | EventExposureEndTimestamp |
| <b>Interface</b>  | Integer                   |
| <b>Access</b>     | RO                        |
| <b>Unit</b>       |                           |
| <b>Visibility</b> | Expert                    |

### 15.3.2.3 Event Exposure End Frame ID

Returns the unique Identifier of the Frame (or image) that generated the Exposure End Event.

| Property          | Value                   |
|-------------------|-------------------------|
| <b>Name</b>       | EventExposureEndFrameID |
| <b>Interface</b>  | Integer                 |
| <b>Access</b>     | RO                      |
| <b>Unit</b>       |                         |
| <b>Visibility</b> | Expert                  |

## 15.4 Event Error Data

Category that contains all the data features related to the Error Event.

### 15.4.1 Summary Table

| Name                                  | Interface | Access | Visibility | Description   |
|---------------------------------------|-----------|--------|------------|---|
| <a href="#">Event Error</a>           | Integer   | RO     | Expert     | Returns the unique identifier of the Error type of Event.                             |
| <a href="#">Event Error Timestamp</a> | Integer   | RO     | Expert     | Returns the Timestamp of the Error Event.   |
| <a href="#">Event Error Frame ID</a>  | Integer   | RO     | Expert     | Returns the unique Identifier of the Frame (or image) that generated the Error Event. |
| <a href="#">Event Error Code</a>      | Integer   | RO     | Expert     | Returns the error code for the error that happened                                    |

### 15.4.2 Event Error Data Features

### 15.4.2.1 Event Error

Returns the unique identifier of the Error type of Event.

| Property          | Value      |
|-------------------|------------|
| <b>Name</b>       | EventError |
| <b>Interface</b>  | Integer    |
| <b>Access</b>     | RO         |
| <b>Unit</b>       |            |
| <b>Visibility</b> | Expert     |
| <b>Value</b>      | 0x9C40     |

### 15.4.2.2 Event Error Timestamp

Returns the Timestamp of the Error Event.

| Property          | Value               |
|-------------------|---------------------|
| <b>Name</b>       | EventErrorTimestamp |
| <b>Interface</b>  | Integer             |
| <b>Access</b>     | RO                  |
| <b>Unit</b>       |                     |
| <b>Visibility</b> | Expert              |

### 15.4.2.3 Event Error Frame ID

Returns the unique Identifier of the Frame (or image) that generated the Error Event.

| Property          | Value             |
|-------------------|-------------------|
| <b>Name</b>       | EventErrorFrameID |
| <b>Interface</b>  | Integer           |
| <b>Access</b>     | RO                |
| <b>Unit</b>       |                   |
| <b>Visibility</b> | Expert            |

### 15.4.2.4 Event Error Code

Returns the error code for the error that happened

| Property          | Value          |
|-------------------|----------------|
| <b>Name</b>       | EventErrorCode |
| <b>Interface</b>  | Integer        |
| <b>Access</b>     | RO             |
| <b>Unit</b>       |                |
| <b>Visibility</b> | Expert         |

## 15.5 Event Serial Port Receive Data

Category that contains all the data features related to the Serial Port Receive Event.

### 15.5.1 Summary Table

| Name  | Interface  | Access | Visibility | Description  |
|---|------------|--------|------------|--|
| <a href="#">Event Serial Port Receive</a>           | Integer    | RO     | Expert     | Returns the unique identifier of the Serial Port Receive type of Event.                |
| <a href="#">Event Serial Port Receive Timestamp</a> | Integer    | RO     | Expert     | Returns the Timestamp of the Serial Port Receive Event.                                |
| <a href="#">Event Serial Data</a>                   | IStringReg |        | Expert     | Returns the serial data that was received.   |
| <a href="#">Event Serial Data Length</a>            | Integer    | RO     | Expert     | Returns the length of the received serial data that was included in the event payload. |
| <a href="#">Event Serial Receive Overflow</a>       | IBoolean   | RO     | Expert     | Returns the status of the event serial receive overflow.                               |

### 15.5.2 Event Serial Port Receive Data Features

#### 15.5.2.1 Event Serial Port Receive

Returns the unique identifier of the Serial Port Receive type of Event.

| Property         | Value                  |
|------------------|------------------------|
| <b>Name</b>      | EventSerialPortReceive |
| <b>Interface</b> | Integer                |
| <b>Access</b>    | RO                     |

| Property   | Value  |
|------------|--------|
| Unit       |        |
| Visibility | Expert |
| Value      | 0x9C45 |

### 15.5.2.2 Event Serial Port Receive Timestamp

Returns the Timestamp of the Serial Port Receive Event.

| Property   | Value                           |
|------------|---------------------------------|
| Name       | EventSerialPortReceiveTimestamp |
| Interface  | Integer                         |
| Access     | RO                              |
| Unit       |                                 |
| Visibility | Expert                          |

### 15.5.2.3 Event Serial Data

Returns the serial data that was received.

| Property   | Value           |
|------------|-----------------|
| Name       | EventSerialData |
| Interface  | IStringReg      |
| Access     |                 |
| Visibility | Expert          |

### 15.5.2.4 Event Serial Data Length

Returns the length of the received serial data that was included in the event payload.

| Property  | Value                 |
|-----------|-----------------------|
| Name      | EventSerialDataLength |
| Interface | Integer               |
| Access    | RO                    |

| Property   | Value  |
|------------|--------|
| Unit       |        |
| Visibility | Expert |

### 15.5.2.5 Event Serial Receive Overflow

Returns the status of the event serial receive overflow.

| Property   | Value                      |
|------------|----------------------------|
| Name       | EventSerialReceiveOverflow |
| Interface  | IBoolean                   |
| Access     | RO                         |
| Visibility | Expert                     |

## 15.6 Event Test Data

Category that contains all the data features related to the Test Event.

### 15.6.1 Summary Table

| Name                                 | Interface | Access | Visibility | Description  |
|--------------------------------------|-----------|--------|------------|--|
| <a href="#">Event Test</a>           | IInteger  | RO     | Expert     | Returns the unique identifier of the Test type of Event. |
| <a href="#">Event Test Timestamp</a> | IInteger  | RO     | Expert     | Returns the Timestamp of the Test Event.                 |

### 15.6.2 Event Test Data Features

#### 15.6.2.1 Event Test

Returns the unique identifier of the Test type of Event.

| Property  | Value     |
|-----------|-----------|
| Name      | EventTest |
| Interface | IInteger  |
| Access    | RO        |
| Unit      |           |

| Property   | Value  |
|------------|--------|
| Visibility | Expert |
| Value      | 0x4FFF |

### 15.6.2.2 Event Test Timestamp

Returns the Timestamp of the Test Event.

| Property   | Value              |
|------------|--------------------|
| Name       | EventTestTimestamp |
| Interface  | Integer            |
| Access     | RO                 |
| Unit       |                    |
| Visibility | Expert             |



# 16 Counter And Timer Control

The Counter and Timer control feature allows you to:

- Create a function generator
- Keep a count of how many times a signal has fired.

Use the CounterSelector to select a counter, either 0 or 1.

Use CounterEventSource to select the event to increment the counter. Possible counter event sources include:

- MHz Tick
- Line Inputs
- User Outputs
- Counter Starts
- Counter Ends
- Logic Block Outputs
- Exposure Start
- Exposure End
- Frame Trigger Wait

When the selected source allows for signal activation, use CounterEventActivation to specify Level Low, Level High, Falling Edge, Rising Edge, or Any Edge.

Use CounterDelay to indicate the maximum number of counts that need to occur before generating the Counter Start event.

Use CounterDuration to indicate the maximum number of counts that need to occur before generating the Counter End event.

**Note:** Only one of CounterTriggerSource or CounterResetSource can be active at a time. Selecting one disables the other.

Use CounterTriggerSource to select the event to start the counter. Possible counter trigger sources include:

- MHz Tick
- Line Inputs
- User Outputs
- Counter Starts
- Counter Ends
- Logic Block Outputs

- Exposure Start
- Exposure End
- Frame Trigger Wait

When the selected source allows for signal activation, use CounterTriggerActivation to specify Level Low, Level High, Falling Edge, Rising Edge, or Any Edge.

Use CounterResetSource to select the event to end the counter. Possible counter reset sources include:

- MHz Tick
- Line Inputs
- User Outputs
- Counter Starts
- Counter Ends
- Logic Block Outputs
- Exposure Start
- Exposure End
- Frame Trigger Wait

When the selected source allows for signal activation, use CounterResetActivation to specify Level Low, Level High, Falling Edge, Rising Edge, or Any Edge.

CounterValue indicates the current counter while CounterStatus indicates the current status. CounterValueAtReset indicates the counter's value when a reset occurred.

## 16.1 Summary Table

| Name   | Interface    | Access | Visibility | Description   |
|--|--------------|--------|------------|---|
| <a href="#">Counter Selector</a>   | IEnumeration |        | Expert     | Selects which counter to configure  |
| <a href="#">Counter Event Source</a><br><a href="#">[Counter Selector]</a>     | IEnumeration | RW     | Expert     | Selects the event that will increment the counter                                 |
| <a href="#">Counter Event Activation</a><br><a href="#">[Counter Selector]</a> | IEnumeration | RW     | Expert     | Selects the activation mode of the event to increment the Counter.                |
| <a href="#">Counter Duration</a> <a href="#">[Counter Selector]</a>            | Integer      |        | Expert     | Sets the duration (or number of events) before the CounterEnd event is generated. |
| <a href="#">Counter Value</a> <a href="#">[Counter Selector]</a>               | Integer      | RO     | Expert     | Current counter value   |
| <a href="#">Counter Value At Reset</a>   | Integer      | RW     | Expert     | Value of the selected Counter when it was reset                                   |

| Name   | Interface    | Access | Visibility | Description  |
|--|--------------|--------|------------|--|
| <a href="#">[Counter Selector]</a>   |              |        |            | by a trigger.  |
| <a href="#">Counter Trigger Source</a><br><a href="#">[Counter Selector]</a>     | IEnumeration | RW     | Expert     | Selects the source of the trigger to start the counter                           |
| <a href="#">Counter Trigger Activation</a><br><a href="#">[Counter Selector]</a> | IEnumeration | RW     | Expert     | Selects the activation mode of the trigger to start the Counter.                 |
| <a href="#">Counter Reset Source</a><br><a href="#">[Counter Selector]</a>       | IEnumeration | RW     | Expert     | Selects the signal that will be the source to reset the Counter.                 |
| <a href="#">Counter Reset Activation</a><br><a href="#">[Counter Selector]</a>   | IEnumeration | RW     | Expert     | Selects the Activation mode of the Counter Reset Source signal.                  |
| <a href="#">Counter Status</a> <a href="#">[Counter Selector]</a>                | IEnumeration | RO     | Expert     | Returns the current status of the Counter.                                       |
| <a href="#">Counter Delay</a> <a href="#">[Counter Selector]</a>                 | Integer      |        | Expert     | Sets the delay (or number of events) before the CounterStart event is generated. |

## 16.2 Counter And Timer Control Features

### 16.2.1 Counter Selector

Selects which counter to configure

| Property          | Value           |
|-------------------|-----------------|
| <b>Name</b>       | CounterSelector |
| <b>Interface</b>  | IEnumeration    |
| <b>Access</b>     |                 |
| <b>Visibility</b> | Expert          |

#### Enumeration Values

Counter0

Counter1

### 16.2.2 Counter Event Source

Selects the event that will increment the counter

| Property          | Value   |
|-------------------|---|
| <b>Name</b>       | CounterEventSource <a href="#">[Counter Selector]</a> |
| <b>Interface</b>  | IEnumeration  |
| <b>Access</b>     | RW  |
| <b>Visibility</b> | Expert  |

#### Enumeration Values

|               |
|---------------|
| Off           |
| MHzTick       |
| Line0         |
| Line1         |
| Line2         |
| Line3         |
| Line4         |
| Line5         |
| Line6         |
| UserOutput0   |
| UserOutput1   |
| UserOutput2   |
| UserOutput3   |
| Counter0Start |
| Counter1Start |
| Counter0End   |
| Counter1End   |
| LogicBlock0   |
| LogicBlock1   |
| ExposureStart |

#### Enumeration Values

ExposureEnd

FrameTriggerWait

### 16.2.3 Counter Event Activation

Selects the activation mode of the event to increment the Counter.

| Property          | Value   |
|-------------------|---|
| <b>Name</b>       | CounterEventActivation <a href="#">[Counter Selector]</a> |
| <b>Interface</b>  | IEnumeration  |
| <b>Access</b>     | RW  |
| <b>Visibility</b> | Expert  |

#### Enumeration Values

LevelLow

LevelHigh

FallingEdge

RisingEdge

AnyEdge

### 16.2.4 Counter Duration

Sets the duration (or number of events) before the CounterEnd event is generated.

| Property          | Value  |
|-------------------|--|
| <b>Name</b>       | CounterDuration <a href="#">[Counter Selector]</a> |
| <b>Interface</b>  | IInteger   |
| <b>Access</b>     |  |
| <b>Unit</b>       |  |
| <b>Visibility</b> | Expert   |

## 16.2.5 Counter Value

Current counter value

| Property          | Value   |
|-------------------|---|
| <b>Name</b>       | CounterValue <a href="#">[Counter Selector]</a> |
| <b>Interface</b>  | Integer   |
| <b>Access</b>     | RO  |
| <b>Unit</b>       |   |
| <b>Visibility</b> | Expert  |

## 16.2.6 Counter Value At Reset

Value of the selected Counter when it was reset by a trigger.

| Property          | Value  |
|-------------------|--|
| <b>Name</b>       | CounterValueAtReset <a href="#">[Counter Selector]</a> |
| <b>Interface</b>  | Integer  |
| <b>Access</b>     | RW   |
| <b>Unit</b>       |  |
| <b>Visibility</b> | Expert   |

## 16.2.7 Counter Trigger Source

Selects the source of the trigger to start the counter

| Property          | Value   |
|-------------------|---|
| <b>Name</b>       | CounterTriggerSource <a href="#">[Counter Selector]</a> |
| <b>Interface</b>  | Enumeration   |
| <b>Access</b>     | RW  |
| <b>Visibility</b> | Expert  |

### Enumeration Values

Off

**Enumeration Values**

|                  |
|------------------|
| Line0            |
| Line1            |
| Line2            |
| Line3            |
| Line4            |
| Line5            |
| Line6            |
| UserOutput0      |
| UserOutput1      |
| UserOutput2      |
| UserOutput3      |
| Counter0Start    |
| Counter1Start    |
| Counter0End      |
| Counter1End      |
| LogicBlock0      |
| LogicBlock1      |
| ExposureStart    |
| ExposureEnd      |
| FrameTriggerWait |

## 16.2.8 Counter Trigger Activation

Selects the activation mode of the trigger to start the Counter.

| Property         | Value   |
|------------------|---|
| <b>Name</b>      | CounterTriggerActivation <a href="#">[Counter Selector]</a> |
| <b>Interface</b> | IEnumeration  |

| Property          | Value  |
|-------------------|--------|
| <b>Access</b>     | RW     |
| <b>Visibility</b> | Expert |

#### Enumeration Values

|             |
|-------------|
| LevelLow    |
| LevelHigh   |
| FallingEdge |
| RisingEdge  |
| AnyEdge     |

## 16.2.9 Counter Reset Source

Selects the signal that will be the source to reset the Counter.

| Property          | Value   |
|-------------------|---|
| <b>Name</b>       | CounterResetSource <a href="#">[Counter Selector]</a> |
| <b>Interface</b>  | IEnumeration  |
| <b>Access</b>     | RW  |
| <b>Visibility</b> | Expert  |

#### Enumeration Values

|       |
|-------|
| Off   |
| Line0 |
| Line1 |
| Line2 |
| Line3 |
| Line4 |
| Line5 |



**Enumeration Values**

|                  |
|------------------|
| Line6            |
| UserOutput0      |
| UserOutput1      |
| UserOutput2      |
| UserOutput3      |
| Counter0Start    |
| Counter1Start    |
| Counter0End      |
| Counter1End      |
| LogicBlock0      |
| LogicBlock1      |
| ExposureStart    |
| ExposureEnd      |
| FrameTriggerWait |

## 16.2.10 Counter Reset Activation

Selects the Activation mode of the Counter Reset Source signal.

| Property          | Value   |
|-------------------|---|
| <b>Name</b>       | CounterResetActivation <a href="#">[Counter Selector]</a> |
| <b>Interface</b>  | IEnumeration  |
| <b>Access</b>     | RW  |
| <b>Visibility</b> | Expert  |

**Enumeration Values**

|           |
|-----------|
| LevelLow  |
| LevelHigh |

#### Enumeration Values

FallingEdge

RisingEdge

AnyEdge

## 16.2.11 Counter Status

Returns the current status of the Counter.

| Property          | Value  |
|-------------------|--|
| <b>Name</b>       | CounterStatus <a href="#">[Counter Selector]</a> |
| <b>Interface</b>  | IEnumeration                                     |
| <b>Access</b>     | RO   |
| <b>Visibility</b> | Expert   |

#### Enumeration Values

CounterIdle

CounterTriggerWait

CounterActive

CounterCompleted

CounterOverflow

## 16.2.12 Counter Delay

Sets the delay (or number of events) before the CounterStart event is generated.

| Property          | Value   |
|-------------------|---|
| <b>Name</b>       | CounterDelay <a href="#">[Counter Selector]</a> |
| <b>Interface</b>  | IInteger  |
| <b>Access</b>     |   |
| <b>Unit</b>       |   |
| <b>Visibility</b> | Expert  |



# 17 Test Control

Test Control provides functionality to allow certain features to be exercised.

There are two features available in Test Control:

**TestEventGenerate** - This feature allows you to generate test events. Executing sends a single TestEvent, which then populates the Event Test Data selector with the ID and the timestamp of when the event occurred.

**TestPendingAck** - This feature allows you to test the device's pending acknowledge feature. When this feature is written, the device waits for the corresponding time period in milliseconds before acknowledging the write.

**Test0001** - This feature is for internal testing only.

If a test fails, an error is produced for the log.

## 17.1 Summary Table

| Name                                | Interface | Access | Visibility | Description   |
|-------------------------------------|-----------|--------|------------|---|
| <a href="#">Test Event Generate</a> | ICommand  | WO     | Guru       | This command generates a test event and sends it to the host. |
| <a href="#">Test 0001</a>           | Integer   | RW     | Expert     | For testing only.   |

## 17.2 Test Control Features

### 17.2.1 Test Event Generate

This command generates a test event and sends it to the host.

| Property          | Value             |
|-------------------|-------------------|
| <b>Name</b>       | TestEventGenerate |
| <b>Interface</b>  | ICommand          |
| <b>Access</b>     | WO                |
| <b>Visibility</b> | Guru              |

### 17.2.2 Test 0001

For testing only.

| Property   | Value    |
|------------|----------|
| Name       | Test0001 |
| Interface  | Integer  |
| Access     | RW       |
| Unit       |          |
| Visibility | Expert   |

# 18 Logic Block Control

For more detail, see [TAN2016005 Using Logic Blocks](#)

A Logic Block is a collection of combinatorial logic and latches that allows the user to create new, custom signals inside the camera. Each Logic Block is comprised of 2 lookup tables (LUT) with programmable inputs, truth tables and a flip flop output. There is a LUT for both the D input (Value LUT) and the enable input (Enable LUT) of the flip flop. Both LUTs have 3 inputs and thus have 8 configuration bits for their truth table.

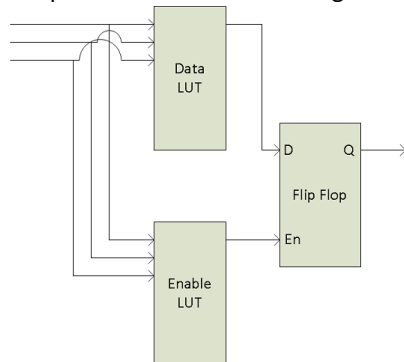

To configure the LUTs first select either the Value or Enable LUT using the LogicBlockLUTSelector, then use the LogicBlockLUTInput to configure the different inputs into the LUT - note that the Value and Enable LUT share the inputs so setting the inputs on one will affect the other. The LogicBlockLUTInputSource selects the internal signal to be used and the LogicBlockLUTInputActivation selects what level or edge to be considered a positive input into the LUT. Once the inputs to the LUT have been selected the entries in the truth table can be configure either individually using the LogicBlockLUTRowIndex and LogicBlockLUTOutput or all at once using the LogicBlockLUTOutputValueAll

The following truth table show a simple AND of Input1 and Input2 while Input0 is not considered ("DON'T CARE").

| Source |   |   | Output |
|--------|---|---|--------|
| 2      | 1 | 0 |        |
| 0      | 0 | 0 | 0      |
| 0      | 0 | 1 | 0      |
| 0      | 1 | 0 | 0      |
| 0      | 1 | 1 | 0      |
| 1      | 0 | 0 | 0      |
| 1      | 0 | 1 | 0      |
| 1      | 1 | 0 | 1      |
| 1      | 1 | 1 | 1      |

To program this function into a LUT write the value of 0xC0 (1100 0000b) to the LogicBlockLUTOutputValueAll.

The details of the output Flip Flop output are shown in the following table. The previous value of the Value LUT will remain on the output until the Enable LUT is set at which point the output will be updated to the new value of the Value LUT. This allows latching of a given signal. To effectively bypass the output latch and pass the Value LUT signal through continuously simple program the Enable LUT truth table to all 1's (LogicBlockLUTOutputValueAll = 0xFF)

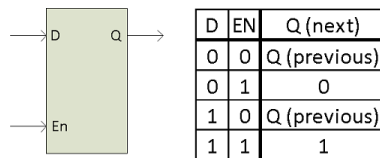

## 18.1 Summary Table

| Name  | Interface    | Access | Visibility | Description   |
|---|--------------|--------|------------|---|
| <a href="#">Logic Block Selector</a>  | IEnumeration |        | Guru       | Selects which LogicBlock to configure   |
| <a href="#">Logic Block LUT Selector</a> [ <a href="#">Logic Block Selector</a> ]                   | IEnumeration |        | Guru       | Selects which LogicBlock LUT to configure   |
| <a href="#">Logic Block LUT Input Selector</a> [ <a href="#">Logic Block LUT Selector</a> ]         | IEnumeration |        | Guru       | Controls which LogicBlockLUT Input Source & Activation to access.                     |
| <a href="#">Logic Block LUT Input Source</a> [ <a href="#">Logic Block LUT Input Selector</a> ]     | IEnumeration | RW     | Guru       | Selects the source for the input into the Logic LUT.                                  |
| <a href="#">Logic Block LUT Input Activation</a> [ <a href="#">Logic Block LUT Input Selector</a> ] | IEnumeration |        | Guru       | Selects the activation mode of the Logic Input Source signal.                         |
| <a href="#">Logic Block LUT Output Value All</a> [ <a href="#">Logic Block LUT Selector</a> ]       | Integer      |        | Guru       | Sets the value of all the output bits in the selected LUT.                            |
| <a href="#">Logic Block LUT Row Index</a> [ <a href="#">Logic Block LUT Selector</a> ]              | Integer      |        | Guru       | Controls the row of the truth table to access in the selected LUT.                    |
| <a href="#">Logic Block LUT Output Value</a> [ <a href="#">Logic Block LUT Row Index</a> ]          | Boolean      |        | Guru       | Controls the output column of the truth table for the selected LogicBlockLUTRowIndex. |

## 18.2 Logic Block Control Features

### 18.2.1 Logic Block Selector

Selects which LogicBlock to configure

| Property    | Value              |
|-------------|--------------------|
| <b>Name</b> | LogicBlockSelector |

| Property          | Value        |
|-------------------|--------------|
| <b>Interface</b>  | IEnumeration |
| <b>Access</b>     |              |
| <b>Visibility</b> | Guru         |

#### Enumeration Values

|             |
|-------------|
| LogicBlock0 |
| LogicBlock1 |

## 18.2.2 Logic Block LUT Selector

Selects which LogicBlock LUT to configure

| Property          | Value  |
|-------------------|--|
| <b>Name</b>       | LogicBlockLUTSelector <a href="#">[Logic Block Selector]</a> |
| <b>Interface</b>  | IEnumeration   |
| <b>Access</b>     |  |
| <b>Visibility</b> | Guru   |

#### Enumeration Values

|        |
|--------|
| Value  |
| Enable |

## 18.2.3 Logic Block LUT Input Selector

Controls which LogicBlockLUT Input Source & Activation to access.

| Property          | Value   |
|-------------------|---|
| <b>Name</b>       | LogicBlockLUTInputSelector <a href="#">[Logic Block LUT Selector]</a> |
| <b>Interface</b>  | IEnumeration  |
| <b>Access</b>     |   |
| <b>Visibility</b> | Guru  |



**Enumeration Values**

|        |
|--------|
| Input0 |
| Input1 |
| Input2 |
| Input3 |

## 18.2.4 Logic Block LUT Input Source

Selects the source for the input into the Logic LUT.

| Property          | Value   |
|-------------------|---|
| <b>Name</b>       | LogicBlockLUTInputSource <a href="#">[Logic Block LUT Input Selector]</a> |
| <b>Interface</b>  | IEnumeration  |
| <b>Access</b>     | RW  |
| <b>Visibility</b> | Guru  |

**Enumeration Values**

|             |
|-------------|
| Zero        |
| Line0       |
| Line1       |
| Line2       |
| Line3       |
| Line4       |
| Line5       |
| Line6       |
| UserOutput0 |
| UserOutput1 |
| UserOutput2 |
| UserOutput3 |

**Enumeration Values**

|                   |
|-------------------|
| Counter0Start     |
| Counter1Start     |
| Counter0End       |
| Counter1End       |
| LogicBlock0       |
| LogicBlock1       |
| ExposureStart     |
| ExposureEnd       |
| FrameTriggerWait  |
| AcquisitionActive |

## 18.2.5 Logic Block LUT Input Activation

Selects the activation mode of the Logic Input Source signal.

| Property          | Value   |
|-------------------|---|
| <b>Name</b>       | LogicBlockLUTInputActivation <a href="#">[Logic Block LUT Input Selector]</a> |
| <b>Interface</b>  | IEnumeration  |
| <b>Access</b>     |   |
| <b>Visibility</b> | Guru  |

**Enumeration Values**

|             |
|-------------|
| LevelLow    |
| LevelHigh   |
| FallingEdge |
| RisingEdge  |
| AnyEdge     |

## 18.2.6 Logic Block LUT Output Value All

Sets the value of all the output bits in the selected LUT.

| Property          | Value  |
|-------------------|--|
| <b>Name</b>       | LogicBlockLUTOutputValueAll <a href="#">[Logic Block LUT Selector]</a> |
| <b>Interface</b>  | Integer  |
| <b>Access</b>     |  |
| <b>Unit</b>       |  |
| <b>Visibility</b> | Guru   |

## 18.2.7 Logic Block LUT Row Index

Controls the row of the truth table to access in the selected LUT.

| Property          | Value  |
|-------------------|--|
| <b>Name</b>       | LogicBlockLUTRowIndex <a href="#">[Logic Block LUT Selector]</a> |
| <b>Interface</b>  | Integer  |
| <b>Access</b>     |  |
| <b>Unit</b>       |  |
| <b>Visibility</b> | Guru   |

## 18.2.8 Logic Block LUT Output Value

Controls the output column of the truth table for the selected LogicBlockLUTRowIndex.

| Property          | Value  |
|-------------------|--|
| <b>Name</b>       | LogicBlockLUTOutputValue <a href="#">[Logic Block LUT Row Index]</a> |
| <b>Interface</b>  | Boolean  |
| <b>Access</b>     |  |
| <b>Visibility</b> | Guru   |

# 19 Digital IO Control

The camera has an 12-pin GPIO connector on the back of the case; refer to the diagram below for wire color-coding.

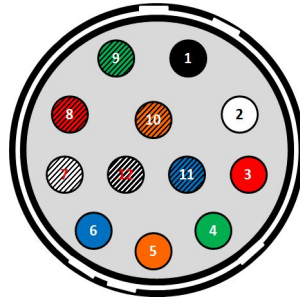

| Color                     | Pin | Line   | Function      | Description  |
|---------------------------|-----|--------|---------------|--|
| Black                     | 1   | N/A    | GND           | DC camera power ground                                     |
| White                     | 2   | N/A    | POWER         | DC camera power  |
| Red                       | 3   | Line 1 | GPIO_OPT_OUT1 | Opto-isolated output (GPO1)                                |
| Green                     | 4   | Line 4 | GPIO_OPT_OUT2 | Opto-isolated output (GPO2)                                |
| Orange                    | 5   | Line 0 | GPIO_OPT_IN1  | Opto-isolated input (GPI1)                                 |
| Blue                      | 6   | Line 3 | GPIO_OPT_IN2  | Opto-isolated input (GPI2)                                 |
| White with black stripes  | 7   | Line 2 | GPIO_TTL_IO3  | TTL input/output 3   |
| Red with black stripes    | 8   | Line 5 | GPIO_TTL_IO4  | TTL input/output 4   |
| Green with black stripes  | 9   | N/A    | GND           | DC camera power ground                                     |
| Orange with black stripes | 10  | N/A    | POWER         | DC camera power  |
| Blue with black stripes   | 11  | Line 6 | 3.3 V OUTPUT  | +3.3 V output, current 120 mA (nominal) - firmware enabled |
| Black with white          | 12  | N/A    | OPTO_GND      | Ground for opto-isolated I/O, not connected to             |

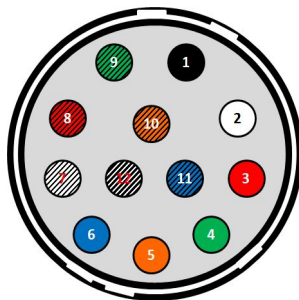

| Color   | Pin | Line | Function | Description   |
|---------|-----|------|----------|---------------|
| stripes |     |      |          | camera ground |

This section describes how to configure the camera's general purpose digital input and outputs (sometimes referred to as GPIO).

Use [LineSelector](#) to choose which of the 4 lines to configure. All the features listed beneath it are controllable on a per line basis.

Use [Line Mode](#) to control the direction - either **Input** or **Output** - of the selected I/O line.

Use [3.3V Enable](#) to supply external circuits with power. This is different than standard logic outputs in that it is comparatively slow to switch but can supply a more significant amount of power. This is only available on some pins.

Use [LineInverter](#) to control a logic inverter on the selected line.

[LineStatus](#) indicates the current status of the selected line. A checked status (enabled) indicates logic high. An unchecked status (disabled) indicates logic low. Since this node must be polled to get its status it should not be used as a real time control for reading internal signals.

[LineStatusAll](#) is a hexadecimal representation of all the line status bits (Line 0 status corresponds to bit 0, Line 1 status with bit 1, etc). This allows simultaneous reading of all line statuses at once.

Use the [LineInputFilterSelector](#) to choose a filter. Filters are unique per line. Use [LineFilterWidth](#) to set the width of the filter in microseconds. There are two choices of filter:

**Deglitch** - designed to filter out any noise or other spurious signals on the line, it does not consider the state to have transitioned until after the Filter Width time has expired. This means that Deglitch introduces a delay in the signal.

**Debounce** - designed to filter out rapid connecting and disconnecting common in mechanical switches. This means that Debounce considers the first edge as valid and won't allow a subsequent change of state until after the debounce time has elapsed.

**Note:** The Deglitch filter is applied before Debounce filter.

Use [LineSource](#) to control what signal is output on the line when the Line Mode is set to output. The choices are:

**Other Lines** - creates a loop back

**User Outputs** - outputs user controllable internal signals

**Counter Active** - shows when a counter is in use

**Logic Blocks** - drives the lines

**Exposure Active** - indicates when the image sensor is exposing

**Frame Trigger Wait** - indicates when the camera is ready to accept a new Frame Start trigger

If a User Output is selected as a Line Source, use [UserOutputSelector](#) to select which bit to use as internal signals within the camera. Use [UserOutputValue](#) to set the selected user output to logic high (enabled) or logic low (disabled).

[UserOutputValueAll](#) is a hexadecimal representation of all the user output bits (User Output 0 corresponds to bit 0, User Output 1 with bit 1, etc). Reading or writing User Output Value All allows simultaneous setting or reading of all user outputs at once.

[LineFormat](#) is read only and indicates what type of circuit the selected line has. The options for Line Format are:

**Tri State** - indicates the line is not driven. This is typical for digital inputs.

**Opto Coupled** - indicates that an opto isolator is being used to isolated the external circuitry from the internal camera electronics.

**Open Drain** - indicates there is an internal MOSFET that will pull the pin low but requires an external pull up resistor to produce a logic level high signal. This is typical for digital outputs.

## 19.1 Summary Table

| Name  | Interface    | Access | Visibility | Description   |
|---|--------------|--------|------------|---|
| <a href="#">Line Selector</a>                         | IEnumeration |        | Expert     | Selects the physical line (or pin) of the external device connector to configure  |
| <a href="#">Line Mode [Line Selector]</a>             | IEnumeration |        | Expert     | Controls if the physical Line is used to Input or Output a signal.  |
| <a href="#">3.3V Enable [Line Selector]</a>           | IBoolean     | RW     | Guru       | Internally generated 3.3V rail. Enable to supply external circuits with power. This is different than standard logic outputs in that it is comparatively slow to switch but can supply a more significant amount of power. This is only available on some pins. |
| <a href="#">Line Inverter [Line Selector]</a>         | IBoolean     | RW     | Expert     | Controls the inversion of the signal of the selected input or output line.  |
| <a href="#">Line Status [Line Selector]</a>           | IBoolean     | RO     | Expert     | Returns the current status of the selected input or output Line   |
| <a href="#">Line Status All</a>                       | IInteger     | RO     | Expert     | Returns the current status of all the line status bits in a hexadecimal representation (Line 0 status corresponds to bit 0, Line 1 status with bit 1, etc). This allows simultaneous reading of all line statuses at once.                                      |
| <a href="#">Input filter Selector [Line Selector]</a> | IEnumeration |        | Expert     | Selects the kind of input filter to configure: Deglitch or Debounce.  |

| Name  | Interface    | Access | Visibility | Description  |
|---|--------------|--------|------------|--|
| <a href="#">Line Filter Width [Input filter Selector]</a> | IFloat       |        | Expert     | Filter width in microseconds for the selected line and filter combination  |
| <a href="#">Line Source [Line Selector]</a>               | IEnumeration |        | Expert     | Selects which internal acquisition or I/O source signal to output on the selected line. LineMode must be Output.   |
| <a href="#">Line Format [Line Selector]</a>               | IEnumeration | RO     | Expert     | Displays the current electrical format of the selected physical input or output Line.  |
| <a href="#">Exposure Active Mode</a>                      | IEnumeration | RW     | Expert     | Control sensor active exposure mode.   |
| <a href="#">User Output Selector</a>                      | IEnumeration |        | Expert     | Selects which bit of the User Output register is set by UserOutputValue.   |
| <a href="#">User Output Value [User Output Selector]</a>  | IBoolean     | RW     | Expert     | Value of the selected user output, either logic high (enabled) or logic low (disabled).  |
| <a href="#">User Output Value All</a>                     | IInteger     |        | Expert     | Returns the current status of all the user output status bits in a hexadecimal representation (UserOutput 0 status corresponds to bit 0, UserOutput 1 status with bit 1, etc). This allows simultaneous reading of all user output statuses at once. |

## 19.2 Digital IO Control Features

### 19.2.1 Line Selector

Selects the physical line (or pin) of the external device connector to configure

| Property          | Value        |
|-------------------|--------------|
| <b>Name</b>       | LineSelector |
| <b>Interface</b>  | IEnumeration |
| <b>Access</b>     |              |
| <b>Visibility</b> | Expert       |

#### Enumeration Values

|       |
|-------|
| Line0 |
| Line1 |
| Line2 |
| Line3 |
| Line4 |
| Line5 |
| Line6 |

## 19.2.2 Line Mode

Controls if the physical Line is used to Input or Output a signal.

| Property          | Value                                    |
|-------------------|--|
| <b>Name</b>       | LineMode <a href="#">[Line Selector]</a> |
| <b>Interface</b>  | IEnumeration                             |
| <b>Access</b>     |  |
| <b>Visibility</b> | Expert                                   |

#### Enumeration Values

|        |
|--------|
| Input  |
| Output |

## 19.2.3 3.3V Enable

Internally generated 3.3V rail. Enable to supply external circuits with power. This is different than standard logic outputs in that it is comparatively slow to switch but can supply a more significant amount of power. This is only available on some pins.

| Property         | Value                                      |
|------------------|--|
| <b>Name</b>      | V3_3Enable <a href="#">[Line Selector]</a> |
| <b>Interface</b> | IBoolean                                   |



| Property          | Value |
|-------------------|-------|
| <b>Access</b>     | RW    |
| <b>Visibility</b> | Guru  |

## 19.2.4 Line Inverter

Controls the inversion of the signal of the selected input or output line.

| Property          | Value  |
|-------------------|--|
| <b>Name</b>       | LineInverter <a href="#">[Line Selector]</a> |
| <b>Interface</b>  | IBoolean                                     |
| <b>Access</b>     | RW   |
| <b>Visibility</b> | Expert                                       |

## 19.2.5 Line Status

Returns the current status of the selected input or output Line

| Property          | Value                                      |
|-------------------|--|
| <b>Name</b>       | LineStatus <a href="#">[Line Selector]</a> |
| <b>Interface</b>  | IBoolean                                   |
| <b>Access</b>     | RO   |
| <b>Visibility</b> | Expert                                     |

## 19.2.6 Line Status All

Returns the current status of all the line status bits in a hexadecimal representation (Line 0 status corresponds to bit 0, Line 1 status with bit 1, etc). This allows simultaneous reading of all line statuses at once.

| Property         | Value         |
|------------------|---------------|
| <b>Name</b>      | LineStatusAll |
| <b>Interface</b> | IInteger      |
| <b>Access</b>    | RO            |
| <b>Unit</b>      |               |

| Property   | Value  |
|------------|--------|
| Visibility | Expert |

## 19.2.7 Input filter Selector

Selects the kind of input filter to configure: Deglitch or Debounce.

| Property   | Value   |
|------------|---|
| Name       | LineInputFilterSelector <a href="#">[Line Selector]</a> |
| Interface  | IEnumeration  |
| Access     |   |
| Visibility | Expert  |

### Enumeration Values

Deglitch

Debounce

## 19.2.8 Line Filter Width

Filter width in microseconds for the selected line and filter combination

| Property   | Value   |
|------------|---|
| Name       | LineFilterWidth <a href="#">[Input filter Selector]</a> |
| Interface  | IFloat  |
| Access     |   |
| Unit       | us  |
| Visibility | Expert  |

## 19.2.9 Line Source

Selects which internal acquisition or I/O source signal to output on the selected line. LineMode must be Output.

| Property | Value                                      |
|----------|--|
| Name     | LineSource <a href="#">[Line Selector]</a> |

| Property          | Value        |
|-------------------|--------------|
| <b>Interface</b>  | IEnumeration |
| <b>Access</b>     |              |
| <b>Visibility</b> | Expert       |

#### Enumeration Values

|                  |
|------------------|
| Off              |
| Line0            |
| Line1            |
| Line2            |
| Line3            |
| Line4            |
| Line5            |
| Line6            |
| UserOutput0      |
| UserOutput1      |
| UserOutput2      |
| UserOutput3      |
| Counter0Active   |
| Counter1Active   |
| LogicBlock0      |
| LogicBlock1      |
| ExposureActive   |
| FrameTriggerWait |
| SerialPort0      |

## 19.2.10 Line Format

Displays the current electrical format of the selected physical input or output Line.

| Property          | Value                                      |
|-------------------|--|
| <b>Name</b>       | LineFormat <a href="#">[Line Selector]</a> |
| <b>Interface</b>  | IEnumeration                               |
| <b>Access</b>     | RO   |
| <b>Visibility</b> | Expert                                     |

#### Enumeration Values

|             |
|-------------|
| NoConnect   |
| TTL         |
| OptoCoupled |
| OpenDrain   |

### 19.2.11 Exposure Active Mode

Control sensor active exposure mode.

| Property          | Value              |
|-------------------|--------------------|
| <b>Name</b>       | ExposureActiveMode |
| <b>Interface</b>  | IEnumeration       |
| <b>Access</b>     | RW                 |
| <b>Visibility</b> | Expert             |

#### Enumeration Values

|           |
|-----------|
| Line1     |
| AnyPixels |
| AllPixels |

### 19.2.12 User Output Selector

Selects which bit of the User Output register is set by UserOutputValue.

| Property          | Value              |
|-------------------|--------------------|
| <b>Name</b>       | UserOutputSelector |
| <b>Interface</b>  | IEnumeration       |
| <b>Access</b>     |                    |
| <b>Visibility</b> | Expert             |

#### Enumeration Values

|                    |
|--------------------|
| <b>UserOutput0</b> |
| <b>UserOutput1</b> |
| <b>UserOutput2</b> |
| <b>UserOutput3</b> |

### 19.2.13 User Output Value

Value of the selected user output, either logic high (enabled) or logic low (disabled).

| Property          | Value  |
|-------------------|--|
| <b>Name</b>       | UserOutputValue <a href="#">[User Output Selector]</a> |
| <b>Interface</b>  | IBoolean   |
| <b>Access</b>     | RW   |
| <b>Visibility</b> | Expert   |

### 19.2.14 User Output Value All

Returns the current status of all the user output status bits in a hexadecimal representation (UserOutput 0 status corresponds to bit 0, UserOutput 1 status with bit 1, etc). This allows simultaneous reading of all user output statuses at once.

| Property         | Value              |
|------------------|--------------------|
| <b>Name</b>      | UserOutputValueAll |
| <b>Interface</b> | IInteger           |
| <b>Access</b>    |                    |

| Property   | Value  |
|------------|--------|
| Unit       |        |
| Visibility | Expert |

## 20 Serial Port Control

### 20.1 Serial Port

The serial port can be used to transmit and receive serial data through the device using the transport layer. The serial data can be sent through the transport layer in image data (via the SerialData Chunk Data), in control data (via the File Access Control), or in event data (via the SerialPortReceive Event).

The serial port to configure is selected using the [SerialPortSelector](#). The physical line on which to receive serial data is set using the [SerialPortSource](#). The physical line on which to transmit serial data is set using the LineSource in the Digital IO Control. The serial port settings for both the receive and transmit can be set using the [SerialPortBaudRate](#), [SerialPortDataBits](#), [SerialPortStopBits](#), and [SerialPortParity](#).

Serial data can be transmitted and received through the File Access Control. Once the serial port file is opened, data can be transmitted via Write operations and received via Read operations. Received serial data can also be obtained through the SerialPortReceive Event which will be generated when data is available or through the SerialData Chunk Data which is appended into each image payload.

The total number of characters in the serial port transmit and receive queues can be monitored using the [SerialTransmitQueueMaxCharacterCount](#) and the [SerialReceiveQueueMaxCharacterCount](#). The current number of characters in the queues can be monitored using the [SerialTransmitQueueCurrentCharacterCount](#) and [SerialReceiveQueueCurrentCharacterCount](#). The [SerialReceiveQueueCurrentCharacterCount](#) reports the maximum number of characters that can be obtained using the File Access Control. The receive queue can be emptied by executing the [SerialReceiveQueueClear](#).

Serial port framing and parity errors are reported using the [SerialRecieveFramingErrorCount](#) and the [SerialReceiveParityErrorCount](#). Overflow errors are reported within the SerialData Chunk Data, the SerialPortReceive Event, or in the FileOperationStatus after executing a Read.

### 20.2 Summary Table

| Name   | Interface    | Access | Visibility | Description   |
|--|--------------|--------|------------|---|
| <a href="#">Serial Port Selector</a>   | IEnumeration | RW     | Expert     | Selects which serial port of the device to control.   |
| <a href="#">Serial Port Source</a> [ <a href="#">Serial Port Selector</a> ]    | IEnumeration | RW     | Expert     | Specifies the physical input Line on which to receive serial data.  |
| <a href="#">Serial Port Baud Rate</a> [ <a href="#">Serial Port Selector</a> ] | IEnumeration | RW     | Expert     | This feature controls the baud rate used by the selected serial port.   |
| <a href="#">Serial Port Data Bits</a> [ <a href="#">Serial Port Selector</a> ] | IInteger     | RW     | Expert     | This feature controls the number of data bits used by the selected serial port. Possible values that can be used are between 5 and 9. |
| <a href="#">Serial Port Stop Bits</a> [ <a href="#">Serial Port Selector</a> ] | IEnumeration | RW     | Expert     | This feature controls the number of stop bits used by the selected serial port.   |

| Name  | Interface    | Access | Visibility | Description   |
|---|--------------|--------|------------|---|
| <a href="#">Serial Port Parity [Serial Port Selector]</a>                     | IEnumeration | RW     | Expert     | This feature controls the parity used by the selected serial port.            |
| <a href="#">Transmit Queue Max Character Count [Serial Port Selector]</a>     | Integer      | RO     | Expert     | >Returns the maximum number of characters in the serial port transmit queue.  |
| <a href="#">Transmit Queue Current Character Count [Serial Port Selector]</a> | Integer      | RO     | Expert     | Returns the number of characters currently in the serial port transmit queue. |
| <a href="#">Receive Queue Max Character Count [Serial Port Selector]</a>      | Integer      | RO     | Expert     | >Returns the maximum number of characters in the serial port receive queue.   |
| <a href="#">Receive Queue Current Character Count [Serial Port Selector]</a>  | Integer      | RO     | Expert     | Returns the number of characters currently in the serial port receive queue.  |
| <a href="#">Receive Queue Clear [Serial Port Selector]</a>                    | ICommand     | WO     | Expert     | This is a command that clears the device serial port receive queue.           |
| <a href="#">Receive Framing Error Count [Serial Port Selector]</a>            | Integer      | RO     | Expert     | Returns the number of framing errors that have occurred on the serial port.   |
| <a href="#">Receive Parity Error Count [Serial Port Selector]</a>             | Integer      | RO     | Expert     | Returns the number of parity errors that have occurred on the serial port.    |

## 20.3 Serial Port Control Features

### 20.3.1 Serial Port Selector

Selects which serial port of the device to control.

| Property          | Value              |
|-------------------|--------------------|
| <b>Name</b>       | SerialPortSelector |
| <b>Interface</b>  | IEnumeration       |
| <b>Access</b>     | RW                 |
| <b>Visibility</b> | Expert             |



### Enumeration Values

SerialPort0

## 20.3.2 Serial Port Source

Specifies the physical input Line on which to receive serial data.

| Property          | Value   |
|-------------------|---|
| <b>Name</b>       | SerialPortSource <a href="#">[Serial Port Selector]</a> |
| <b>Interface</b>  | IEnumeration  |
| <b>Access</b>     | RW  |
| <b>Visibility</b> | Expert  |

### Enumeration Values

Line0

Line1

Line2

Line3

Line4

Line5

Line6

Off

## 20.3.3 Serial Port Baud Rate

This feature controls the baud rate used by the selected serial port.

| Property          | Value   |
|-------------------|---|
| <b>Name</b>       | SerialPortBaudRate <a href="#">[Serial Port Selector]</a> |
| <b>Interface</b>  | IEnumeration  |
| <b>Access</b>     | RW  |
| <b>Visibility</b> | Expert  |

#### Enumeration Values

|            |
|------------|
| Baud300    |
| Baud600    |
| Baud1200   |
| Baud2400   |
| Baud4800   |
| Baud9600   |
| Baud14400  |
| Baud19200  |
| Baud38400  |
| Baud57600  |
| Baud115200 |

### 20.3.4 Serial Port Data Bits

This feature controls the number of data bits used by the selected serial port. Possible values that can be used are between 5 and 9.

| Property          | Value   |
|-------------------|---|
| <b>Name</b>       | SerialPortDataBits <a href="#">[Serial Port Selector]</a> |
| <b>Interface</b>  | Integer   |
| <b>Access</b>     | RW  |
| <b>Unit</b>       |   |
| <b>Visibility</b> | Expert  |

### 20.3.5 Serial Port Stop Bits

This feature controls the number of stop bits used by the selected serial port.

| Property         | Value   |
|------------------|---|
| <b>Name</b>      | SerialPortStopBits <a href="#">[Serial Port Selector]</a> |
| <b>Interface</b> | IEnumeration  |

| Property          | Value  |
|-------------------|--------|
| <b>Access</b>     | RW     |
| <b>Visibility</b> | Expert |

#### Enumeration Values

|                      |
|----------------------|
| <b>Bits1</b>         |
| <b>Bits1AndAHalf</b> |
| <b>Bits2</b>         |

## 20.3.6 Serial Port Parity

This feature controls the parity used by the selected serial port.

| Property          | Value   |
|-------------------|---|
| <b>Name</b>       | SerialPortParity <a href="#">[Serial Port Selector]</a> |
| <b>Interface</b>  | IEnumeration  |
| <b>Access</b>     | RW  |
| <b>Visibility</b> | Expert  |

#### Enumeration Values

|              |
|--------------|
| <b>None</b>  |
| <b>Odd</b>   |
| <b>Even</b>  |
| <b>Mark</b>  |
| <b>Space</b> |

## 20.3.7 Transmit Queue Max Character Count

>Returns the maximum number of characters in the serial port transmit queue.

| Property    | Value   |
|-------------|---|
| <b>Name</b> | SerialTransmitQueueMaxCharacterCount <a href="#">[Serial Port Selector]</a> |

| Property          | Value   |
|-------------------|---------|
| <b>Interface</b>  | Integer |
| <b>Access</b>     | RO      |
| <b>Unit</b>       |         |
| <b>Visibility</b> | Expert  |

### 20.3.8 Transmit Queue Current Character Count

Returns the number of characters currently in the serial port transmit queue.

| Property          | Value   |
|-------------------|---|
| <b>Name</b>       | SerialTransmitQueueCurrentCharacterCount <a href="#">[Serial Port Selector]</a> |
| <b>Interface</b>  | Integer   |
| <b>Access</b>     | RO  |
| <b>Unit</b>       |   |
| <b>Visibility</b> | Expert  |

### 20.3.9 Receive Queue Max Character Count

>Returns the maximum number of characters in the serial port receive queue.

| Property          | Value  |
|-------------------|--|
| <b>Name</b>       | SerialReceiveQueueMaxCharacterCount <a href="#">[Serial Port Selector]</a> |
| <b>Interface</b>  | Integer  |
| <b>Access</b>     | RO   |
| <b>Unit</b>       |  |
| <b>Visibility</b> | Expert   |

### 20.3.10 Receive Queue Current Character Count

Returns the number of characters currently in the serial port receive queue.

| Property    | Value  |
|-------------|--|
| <b>Name</b> | SerialReceiveQueueCurrentCharacterCount <a href="#">[Serial Port Selector]</a> |

| Property          | Value   |
|-------------------|---------|
| <b>Interface</b>  | Integer |
| <b>Access</b>     | RO      |
| <b>Unit</b>       |         |
| <b>Visibility</b> | Expert  |

### 20.3.11 Receive Queue Clear

This is a command that clears the device serial port receive queue.

| Property          | Value  |
|-------------------|--|
| <b>Name</b>       | SerialReceiveQueueClear <a href="#">[Serial Port Selector]</a> |
| <b>Interface</b>  | ICommand   |
| <b>Access</b>     | WO   |
| <b>Visibility</b> | Expert   |

### 20.3.12 Receive Framing Error Count

Returns the number of framing errors that have occurred on the serial port.

| Property          | Value   |
|-------------------|---|
| <b>Name</b>       | SerialReceiveFramingErrorCount <a href="#">[Serial Port Selector]</a> |
| <b>Interface</b>  | Integer   |
| <b>Access</b>     | RO  |
| <b>Unit</b>       |   |
| <b>Visibility</b> | Expert  |

### 20.3.13 Receive Parity Error Count

Returns the number of parity errors that have occurred on the serial port.

| Property    | Value  |
|-------------|--|
| <b>Name</b> | SerialReceiveParityErrorCount <a href="#">[Serial Port Selector]</a> |

| Property          | Value   |
|-------------------|---------|
| <b>Interface</b>  | Integer |
| <b>Access</b>     | RO      |
| <b>Unit</b>       |         |
| <b>Visibility</b> | Expert  |

## 20 File Access

### 20.1 File Access

The file access interface allows access to the cameras file system.

It provides access to the cameras user set files, LUT files and a user definable file.

Usage of the file access features and registers should not be attempted directly. Instead access the file system through the file access interface of the host application.

The user set files are treated differently than the other files in the system. These file when uploaded will modify the user set setting within the camera. If the user set file is from an older version of the camera or a different model, the user sets with in the file will be converted to the appropriate user sets for the new firmware. The file will then be replaced with the updated user set file. If the file contains user sets that are not appropriate for the firmware version on the camera, they will be ignored and discarded. If the file has been modified in any way, the file will be discarded and regenerated.

While a file is open within the file access interface, the camera will not be able to start acquisition. Also, the FileAccessExecute command will be disabled when the camera is in acquisition mode. Care should be taken to not leave any file open within the camera's file system as it will disable the start acquisition register without any feedback as to why.

### 20.2 Summary Table

| Name                                    | Interface    | Access | Visibility | Description  |
|---|--------------|--------|------------|--|
| <a href="#">File Selector</a>           | IEnumeration | RW     | Guru       | Selects which file is being operated on. This must be set before performing any file operations.                                       |
| <a href="#">File Operation Selector</a> | IEnumeration | RW     | Guru       | Sets operation to execute on the selected file when the execute command is given.  |
| <a href="#">File Operation Execute</a>  | ICommand     | WO     | Guru       | This is a command that executes the selected file operation on the selected file.  |
| <a href="#">File Open Mode</a>          | IEnumeration | RW     | Guru       | The mode of the file when it is opened. The file can be opened for reading, writing or both. This must be set before opening the file. |
| <a href="#">File Access Buffer</a>      | IRegister    | RW     | Guru       | Defines the intermediate access buffer that allows the exchange of data between the device file storage and the application.           |
| <a href="#">File Access Offset</a>      | Integer      | RW     | Guru       | Controls the Offset of the mapping between the device file storage and the FileAccessBuffer.   |
| <a href="#">File Access</a>             | Integer      | RW     | Guru       | Controls the Length of the mapping between the device file   |

| Name                                  | Interface    | Access | Visibility | Description  |
|---------------------------------------|--------------|--------|------------|--|
| <a href="#">Length</a>                |              |        |            | storage and the FileAccessBuffer.  |
| <a href="#">File Operation Status</a> | IEnumeration | RO     | Guru       | Represents the file operation execution status.  |
| <a href="#">File Operation Result</a> | Integer      | RO     | Guru       | Represents the file operation result. For Read or Write operations, the number of successfully read/written bytes is returned. |
| <a href="#">File Size</a>             | Integer      | RO     | Guru       | Represents the size of the selected file in bytes.   |

## 20.3 File Access Features

### 20.3.1 File Selector

Selects which file is being operated on. This must be set before performing any file operations.

| Property          | Value        |
|-------------------|--------------|
| <b>Name</b>       | FileSelector |
| <b>Interface</b>  | IEnumeration |
| <b>Access</b>     | RW           |
| <b>Visibility</b> | Guru         |

#### Enumeration Values

|                |
|----------------|
| UserSetDefault |
| UserSet0       |
| UserSet1       |
| UserFile1      |
| SerialPort0    |

### 20.3.2 File Operation Selector

Sets operation to execute on the selected file when the execute command is given.



| Property          | Value                 |
|-------------------|-----------------------|
| <b>Name</b>       | FileOperationSelector |
| <b>Interface</b>  | IEnumeration          |
| <b>Access</b>     | RW                    |
| <b>Visibility</b> | Guru                  |

#### Enumeration Values

|        |
|--------|
| Open   |
| Close  |
| Read   |
| Write  |
| Delete |

### 20.3.3 File Operation Execute

This is a command that executes the selected file operation on the selected file.

| Property          | Value                |
|-------------------|----------------------|
| <b>Name</b>       | FileOperationExecute |
| <b>Interface</b>  | ICommand             |
| <b>Access</b>     | WO                   |
| <b>Visibility</b> | Guru                 |

### 20.3.4 File Open Mode

The mode of the file when it is opened. The file can be opened for reading, writing or both. This must be set before opening the file.

| Property         | Value        |
|------------------|--------------|
| <b>Name</b>      | FileOpenMode |
| <b>Interface</b> | IEnumeration |
| <b>Access</b>    | RW           |

| Property | Value |
|----------|-------|
|----------|-------|

|                   |      |
|-------------------|------|
| <b>Visibility</b> | Guru |
|-------------------|------|

#### Enumeration Values

|             |
|-------------|
| <b>Read</b> |
|-------------|

|              |
|--------------|
| <b>Write</b> |
|--------------|

|                  |
|------------------|
| <b>ReadWrite</b> |
|------------------|

## 20.3.5 File Access Buffer

Defines the intermediate access buffer that allows the exchange of data between the device file storage and the application.

| Property | Value |
|----------|-------|
|----------|-------|

|             |                  |
|-------------|------------------|
| <b>Name</b> | FileAccessBuffer |
|-------------|------------------|

|                  |           |
|------------------|-----------|
| <b>Interface</b> | IRegister |
|------------------|-----------|

|               |    |
|---------------|----|
| <b>Access</b> | RW |
|---------------|----|

|                   |      |
|-------------------|------|
| <b>Visibility</b> | Guru |
|-------------------|------|

## 20.3.6 File Access Offset

Controls the Offset of the mapping between the device file storage and the FileAccessBuffer.

| Property | Value |
|----------|-------|
|----------|-------|

|             |                  |
|-------------|------------------|
| <b>Name</b> | FileAccessOffset |
|-------------|------------------|

|                  |         |
|------------------|---------|
| <b>Interface</b> | Integer |
|------------------|---------|

|               |    |
|---------------|----|
| <b>Access</b> | RW |
|---------------|----|

|             |   |
|-------------|---|
| <b>Unit</b> | B |
|-------------|---|

|                   |      |
|-------------------|------|
| <b>Visibility</b> | Guru |
|-------------------|------|

## 20.3.7 File Access Length

Controls the Length of the mapping between the device file storage and the FileAccessBuffer.

| Property          | Value            |
|-------------------|------------------|
| <b>Name</b>       | FileAccessLength |
| <b>Interface</b>  | IInteger         |
| <b>Access</b>     | RW               |
| <b>Unit</b>       | B                |
| <b>Visibility</b> | Guru             |

## 20.3.8 File Operation Status

Represents the file operation execution status.

| Property          | Value               |
|-------------------|---------------------|
| <b>Name</b>       | FileOperationStatus |
| <b>Interface</b>  | IEnumeration        |
| <b>Access</b>     | RO                  |
| <b>Visibility</b> | Guru                |

### Enumeration Values

|                 |
|-----------------|
| <b>Success</b>  |
| <b>Failure</b>  |
| <b>Overflow</b> |

## 20.3.9 File Operation Result

Represents the file operation result. For Read or Write operations, the number of successfully read/written bytes is returned.

| Property         | Value               |
|------------------|---------------------|
| <b>Name</b>      | FileOperationResult |
| <b>Interface</b> | IInteger            |
| <b>Access</b>    | RO                  |
| <b>Unit</b>      |                     |

| Property   | Value |
|------------|-------|
| Visibility | Guru  |

## 20.3.10 File Size

Represents the size of the selected file in bytes.

| Property   | Value    |
|------------|----------|
| Name       | FileSize |
| Interface  | Integer  |
| Access     | RO       |
| Unit       | B        |
| Visibility | Guru     |

# 21 Transfer Control

The Transfer Control category contains features that control the transferring of image data to the host.

An acquisition generates frames that are optionally processed and may have extra data appended (chunk data) before being placed in the transfer queue for transmission out of the device. Once the image data has gone through any processing and had the appropriate data appended it is referred to as a block. These blocks are then handed to the transfer module to be sent out of the device on data streams. The transfer module then transmits these blocks externally on stream channels.

This can be manually or automatically controlled. Use the [Transfer Control Mode](#) to select the control method. There are three options: **Basic**, **Automatic**, and **User Controlled**.

In both **Basic** and **Automatic** mode the camera starts transmitting data as soon as there is enough data to fill a link layer packet. This reduces the latency between when the image was acquired and when it is available to the user. As long as the link layer is able to transfer data blocks faster than they are being generated the camera continuously sends one image after another on the stream channel.

There is a **Transfer Queue** which starts to fill up if the link slows down.

The [Transfer Queue Max Block Count](#) indicates the transfer queue's maximum capacity.

The [Transfer Queue Current Block Count](#) indicates the number of blocks currently in the transfer queue.

The [Transfer Queue Overflow Count](#) indicates the number of blocks that have been lost before being transmitted.

The [Transfer Queue Mode](#) indicates the mechanism for transmitting and overwriting blocks in the transfer queue. It is First In First Out, which means the oldest block in the queue is always sent next on the stream channel.

Once the transfer queue is full the camera overwrites the oldest block in the queue with the new block arriving from the acquisition and processing modules that has not already begun being transmitted. At this point the Queue Overflow is incremented. Once the image that is currently being transmitted finishes, the transmission module transmits the next oldest image in the transfer queue.

In **User Controlled** mode you can directly control the transfer of blocks. Use the Transfer Operation Mode to select an operation mode. There are two options: **Continuous** and **Multi Block**.

**Continuous** sends images without stopping in the same manner as Basic/Automatic, but you can use [Transfer Start](#) and [Transfer Stop](#) to control the streaming while acquisition runs independently.

**Multi Block** transmits a specified number of blocks and then stops. Use the [Transfer Block Count](#) to specify the number of blocks. Use the [Transfer Start](#) command to initiate a multi block transfer.

**Note:** Acquisition can be started and stopped without affecting the transfer queue or transfer state however closing the stream channel clears both the queue and any pending transmissions.

## 21.1 Summary Table

| Name   | Interface    | Access | Visibility | Description   |
|--|--------------|--------|------------|---|
| <a href="#">Transfer Control Mode</a>              | IEnumeration | RW     | Expert     | Selects the control method for the transfers. Basic and Automatic start transmitting data as soon as there is enough data to fill a link layer packet. User Controlled allows you to directly control the transfer of blocks.     |
| <a href="#">Transfer Operation Mode</a>            | IEnumeration | RW     | Expert     | Selects the operation mode of the transfer. Continuous is similar to Basic/Automatic but you can start/stop the transfer while acquisition runs independently. Multi Block transmits a specified number of blocks and then stops. |
| <a href="#">Transfer Block Count</a>               | Integer      | RW     | Expert     | Specifies the number of data blocks (images) that the device should stream before stopping. This feature is only active if the Transfer Operation Mode is set to Multi Block.   |
| <a href="#">Transfer Queue Max Block Count</a>     | Integer      | RO     | Expert     | Returns the maximum number of data blocks (images) in the transfer queue  |
| <a href="#">Transfer Queue Current Block Count</a> | Integer      | RO     | Expert     | Returns number of data blocks (images) currently in the transfer queue.   |
| <a href="#">Transfer Queue Overflow Count</a>      | Integer      | RO     | Expert     | Returns number of images that have been lost before being transmitted because the transmit queue hasn't been cleared fast enough.   |
| <a href="#">Transfer Queue Mode</a>                | IEnumeration | RW     | Expert     | Specifies the operation mode of the transfer queue.   |
| <a href="#">Transfer Start</a>                     | ICommand     | WO     | Expert     | Starts the streaming of data blocks (images) out of the device. This feature is available when the Transfer Control Mode is set to User Controlled.   |
| <a href="#">Transfer Stop</a>                      | ICommand     | WO     | Expert     | Stops the streaming of data block (images). The current block transmission is completed. This feature is available when the Transfer Control Mode is set to User Controlled.  |

## 21.2 Transfer Control Features

## 21.2.1 Transfer Control Mode

Selects the control method for the transfers. Basic and Automatic start transmitting data as soon as there is enough data to fill a link layer packet. User Controlled allows you to directly control the transfer of blocks.

| Property          | Value               |
|-------------------|---------------------|
| <b>Name</b>       | TransferControlMode |
| <b>Interface</b>  | IEnumeration        |
| <b>Access</b>     | RW                  |
| <b>Visibility</b> | Expert              |

### Enumeration Values

Basic

Automatic

UserControlled

## 21.2.2 Transfer Operation Mode

Selects the operation mode of the transfer. Continuous is similar to Basic/Automatic but you can start/stop the transfer while acquisition runs independently. Multi Block transmits a specified number of blocks and then stops.

| Property          | Value                 |
|-------------------|-----------------------|
| <b>Name</b>       | TransferOperationMode |
| <b>Interface</b>  | IEnumeration          |
| <b>Access</b>     | RW                    |
| <b>Visibility</b> | Expert                |

### Enumeration Values

Continuous

MultiBlock

## 21.2.3 Transfer Block Count

Specifies the number of data blocks (images) that the device should stream before stopping. This feature is only active if the Transfer Operation Mode is set to Multi Block.

| Property          | Value              |
|-------------------|--------------------|
| <b>Name</b>       | TransferBlockCount |
| <b>Interface</b>  | Integer            |
| <b>Access</b>     | RW                 |
| <b>Unit</b>       |                    |
| <b>Visibility</b> | Expert             |

## 21.2.4 Transfer Queue Max Block Count

Returns the maximum number of data blocks (images) in the transfer queue

| Property          | Value                      |
|-------------------|----------------------------|
| <b>Name</b>       | TransferQueueMaxBlockCount |
| <b>Interface</b>  | Integer                    |
| <b>Access</b>     | RO                         |
| <b>Unit</b>       |                            |
| <b>Visibility</b> | Expert                     |

## 21.2.5 Transfer Queue Current Block Count

Returns number of data blocks (images) currently in the transfer queue.

| Property          | Value                          |
|-------------------|--------------------------------|
| <b>Name</b>       | TransferQueueCurrentBlockCount |
| <b>Interface</b>  | Integer                        |
| <b>Access</b>     | RO                             |
| <b>Unit</b>       |                                |
| <b>Visibility</b> | Expert                         |

## 21.2.6 Transfer Queue Overflow Count

Returns number of images that have been lost before being transmitted because the transmit queue hasn't been cleared fast enough.



| Property          | Value                      |
|-------------------|----------------------------|
| <b>Name</b>       | TransferQueueOverflowCount |
| <b>Interface</b>  | Integer                    |
| <b>Access</b>     | RO                         |
| <b>Unit</b>       |                            |
| <b>Visibility</b> | Expert                     |

## 21.2.7 Transfer Queue Mode

Specifies the operation mode of the transfer queue.

| Property          | Value             |
|-------------------|-------------------|
| <b>Name</b>       | TransferQueueMode |
| <b>Interface</b>  | IEnumeration      |
| <b>Access</b>     | RW                |
| <b>Visibility</b> | Expert            |

### Enumeration Values

**FirstInFirstOut**

## 21.2.8 Transfer Start

Starts the streaming of data blocks (images) out of the device. This feature is available when the Transfer Control Mode is set to User Controlled.

| Property          | Value         |
|-------------------|---------------|
| <b>Name</b>       | TransferStart |
| <b>Interface</b>  | ICommand      |
| <b>Access</b>     | WO            |
| <b>Visibility</b> | Expert        |

## 21.2.9 Transfer Stop

Stops the streaming of data block (images). The current block transmission is completed. This feature is available when the Transfer Control Mode is set to User Controlled.

| Property          | Value        |
|-------------------|--------------|
| <b>Name</b>       | TransferStop |
| <b>Interface</b>  | ICommand     |
| <b>Access</b>     | WO           |
| <b>Visibility</b> | Expert       |

# Contacting Us

For any questions, concerns or comments please contact us via the following methods:

|                       |   |
|-----------------------|---|
| <b>Email</b>          | <a href="#">General questions</a>   |
| <b>Support Ticket</b> | <a href="#">Technical support</a>   |
| <b>Chat</b>           | Go to the Support Page for any product on the FLIR machine vision page and click the chat icon              |
| <b>Website</b>        | Find specifications, support articles, downloads on the product page at <a href="#">FLIR machine vision</a> |