

## TECHNICAL REFERENCE

---

# FLIR **ORYX**<sup>®</sup>

## ORX-10G-123S6



Revised 10/27/2017



## FCC Compliance

This device complies with Part 15 of the FCC rules. Operation is subject to the following two conditions: (1) This device may not cause harmful interference, and (2) this device must accept any interference received, including interference that may cause undesirable operation.

## Korean EMC Certification

The KCC symbol indicates that this product complies with Korea's Electrical Communication Basic Law regarding EMC testing for electromagnetic interference (EMI) and susceptibility (EMS).

## Hardware Warranty

The warranty for the Oryx camera is 3 years. For detailed information on how to repair or replace your camera, please see the [terms and conditions on our website](#).

## Export Control

The ECCN for this product is EAR099.

## WEEE

The symbol indicates that this product may not be treated as household waste. Please ensure this product is properly disposed as inappropriate waste handling of this product may cause potential hazards to the environment and human health. For more detailed information about recycling of this product, please contact us.



## Trademarks

Names and marks appearing on the products herein are either registered trademarks or trademarks of FLIR Systems, Inc. and/or its subsidiaries.

## Licensing

To view the licenses of open source packages used in this product please see [What open source packages does firmware use?](#)



# Table of Contents

<b>1 Oryx Technical Reference</b> .....	<b>1</b>
<b>2 ORX-10G-123S6 Specifications</b> .....	<b>2</b>
<b>2.1 General</b> .....	<b>2</b>
<b>2.2 ORX-10G-123S6M Supported Pixel Formats</b> .....	<b>3</b>
<b>2.3 ORX-10G-123S6M Frame Rates</b> .....	<b>3</b>
<b>2.4 ORX-10G-123S6C Supported Pixel Formats</b> .....	<b>5</b>
<b>2.5 ORX-10G-123S6C Frame Rates</b> .....	<b>6</b>
<b>3 Acquisition Control</b> .....	<b>9</b>
<b>3.1 Acquisition and Frame Rate</b> .....	<b>9</b>
<b>3.2 Exposure Time Modes</b> .....	<b>9</b>
<b>3.2.1 Trigger Features</b> .....	<b>9</b>
<b>3.3 Summary Table</b> .....	<b>10</b>
<b>3.4 Acquisition Control Features</b> .....	<b>12</b>
<b>3.4.1 Acquisition Mode</b> .....	<b>12</b>
<b>3.4.2 Acquisition Start</b> .....	<b>13</b>
<b>3.4.3 Acquisition Stop</b> .....	<b>13</b>
<b>3.4.4 Acquisition Frame Count</b> .....	<b>13</b>
<b>3.4.5 Acquisition Burst Frame Count</b> .....	<b>14</b>
<b>3.4.6 Exposure Mode</b> .....	<b>14</b>
<b>3.4.7 Exposure Time</b> .....	<b>14</b>
<b>3.4.8 Exposure Auto</b> .....	<b>15</b>
<b>3.4.9 Acquisition Frame Rate</b> .....	<b>15</b>
<b>3.4.10 Resulting Frame Rate</b> .....	<b>15</b>
<b>3.4.11 Acquisition Frame Rate Enable</b> .....	<b>16</b>
<b>3.4.12 Acquisition Line Rate</b> .....	<b>16</b>
<b>3.4.13 Trigger Selector</b> .....	<b>16</b>
<b>3.4.14 Trigger Mode</b> .....	<b>17</b>
<b>3.4.15 Trigger Software</b> .....	<b>17</b>
<b>3.4.16 Trigger Source</b> .....	<b>18</b>
<b>3.4.17 Trigger Activation</b> .....	<b>19</b>
<b>3.4.18 Trigger Overlap</b> .....	<b>19</b>
<b>3.4.19 Trigger Delay</b> .....	<b>19</b>

3.4.20 Sensor Shutter Mode .....	20
4 Analog Control .....	21
4.1 Gain .....	21
4.2 Black Level .....	21
4.3 White Balance .....	21
4.4 Gamma .....	22
4.5 Sharpening .....	22
4.6 Summary Table .....	23
4.7 Analog Control Features .....	24
4.7.1 Gain Selector .....	24
4.7.2 Gain .....	25
4.7.3 Gain Auto .....	25
4.7.4 Black Level Selector .....	25
4.7.5 Black Level Raw .....	26
4.7.6 Black Level .....	26
4.7.7 Black Level Clamping Enable .....	27
4.7.8 Balance Ratio Selector .....	27
4.7.9 Balance Ratio .....	27
4.7.10 Balance White Auto .....	28
4.7.11 Gamma .....	28
4.7.12 Gamma Enable .....	28
4.7.13 Sharpening Enable .....	29
4.7.14 Sharpening Auto .....	29
4.7.15 Sharpening .....	29
4.7.16 Sharpening Threshold .....	30
5 Image Format Control .....	31
5.1 Binning/Decimation .....	31
5.1.1 Binning/Decimation Feature Dependency .....	32
5.2 Pixel Format .....	32
5.2.1 Single Channel 8-bit and 16-bit Formats .....	32
5.2.2 Single Channel 12-bit Formats .....	33
5.2.3 Multi-Channel Formats .....	33
5.2.3.1 YCbCr8 / YUV444Packed .....	34
5.2.3.2 YCbCr422_8 / YUV422Packed .....	34
5.2.3.3 YCbCr411_8 / YUV411Packed .....	35



5.3 ADC Bit Depth .....	35
5.4 Test Pattern .....	36
5.5 Region Of Interest .....	36
5.6 Reverse X .....	37
5.7 Reverse Y .....	37
5.8 Summary Table .....	37
5.9 Image Format Control Features .....	40
5.9.1 Sensor Width .....	40
5.9.2 Sensor Height .....	40
5.9.3 Width Max .....	41
5.9.4 Height Max .....	41
5.9.5 Width .....	41
5.9.6 Height .....	42
5.9.7 Offset X .....	42
5.9.8 Offset Y .....	42
5.9.9 Pixel Format .....	43
5.9.10 Pixel Size .....	44
5.9.11 Pixel Color Filter .....	45
5.9.12 Pixel Dynamic Range Min .....	46
5.9.13 Pixel Dynamic Range Max .....	46
5.9.14 ISP Enable .....	46
5.9.15 Binning Selector .....	47
5.9.16 Binning Horizontal Mode .....	47
5.9.17 Binning Vertical Mode .....	48
5.9.18 Binning Horizontal .....	48
5.9.19 Binning Vertical .....	48
5.9.20 Decimation Selector .....	49
5.9.21 Decimation Horizontal Mode .....	49
5.9.22 Decimation Vertical Mode .....	50
5.9.23 Decimation Horizontal .....	50
5.9.24 Decimation Vertical .....	50
5.9.25 Reverse X .....	51
5.9.26 Reverse Y .....	51
5.9.27 Test Pattern Generator Selector .....	51
5.9.28 Test Pattern .....	52



5.9.29 ADC Bit Depth .....	52
<b>6 Device Control .....</b>	<b>54</b>
6.1 General Information .....	54
6.2 Bandwidth .....	54
6.3 Timestamp .....	54
6.4 Power Supply .....	54
6.5 Device Reset .....	54
6.6 Summary Table .....	54
<b>6.7 Device Control Features .....</b>	<b>57</b>
6.7.1 Device Scan Type .....	57
6.7.2 Device Vendor Name .....	57
6.7.3 Device Model Name .....	57
6.7.4 Sensor Description .....	58
6.7.5 Device Manufacturer Info .....	58
6.7.6 Firmware Version .....	58
6.7.7 Serial Number .....	59
6.7.8 User ID .....	59
6.7.9 Device TL Type .....	59
6.7.10 TL Version Major .....	60
6.7.11 TL Version Minor .....	60
6.7.12 Device Max Throughput .....	60
6.7.13 Link Speed .....	61
6.7.14 Device Link Throughput Limit .....	61
6.7.15 Device Link Bandwidth Reserve .....	61
6.7.16 Device Link Current Throughput .....	62
6.7.17 Stream Channel Count .....	62
6.7.18 Event Channel Count .....	62
6.7.19 Character Set .....	63
6.7.20 Device Reset .....	63
6.7.21 Device Indicator Mode .....	63
6.7.22 Registers Endianness .....	64
6.7.23 Device Temperature Selector .....	64
6.7.24 Device Temperature .....	65
6.7.25 Timestamp Reset .....	65
6.7.26 Timestamp Latch .....	65

6.7.27 Timestamp Latch Value .....	66
6.7.28 Device Power Supply Selector .....	66
6.7.29 Power Supply Voltage .....	66
6.7.30 Power Supply Current .....	67
6.7.31 Device Uptime .....	67
6.7.32 Link Uptime .....	67
6.7.33 Enumeration Count .....	68
6.7.34 Factory Reset .....	68
6.7.35 Max Device Reset Time .....	68
<b>7 Transport Layer Control .....</b>	<b>70</b>
7.1 Summary Table .....	70
7.2 Transport Layer Control Features .....	70
7.2.1 Payload Size .....	70
7.2.2 GigE Vision .....	71
7.2.3 Link Error Count .....	71
7.2.4 Packet Resend Request Count .....	71
7.2.5 Packet Resend Requests Dropped Count .....	72
7.3 GigE Vision .....	72
7.3.1 Summary Table .....	72
7.3.2 GigE Vision Features .....	76
7.3.2.1 Supported Option Selector .....	76
7.3.2.2 Supported Option .....	77
7.3.2.3 Interface Selector .....	77
7.3.2.4 MAC Address .....	78
7.3.2.5 Current IP Configuration LLA .....	78
7.3.2.6 Current IP Configuration DHCP .....	78
7.3.2.7 Current IP Configuration Persistent IP .....	79
7.3.2.8 Current IP Address .....	79
7.3.2.9 Current Subnet Mask .....	79
7.3.2.10 Current Default Gateway .....	80
7.3.2.11 First URL .....	80
7.3.2.12 Second URL .....	80
7.3.2.13 Number Of Interfaces .....	80
7.3.2.14 Persistent IP Address .....	81
7.3.2.15 Persistent Subnet Mask .....	81

7.3.2.16 Persistent Default Gateway .....	81
7.3.2.17 Heartbeat Timeout .....	82
7.3.2.18 Timestamp Tick Frequency .....	82
7.3.2.19 Pending Acknowledge Enable .....	82
7.3.2.20 Heartbeat Disable .....	82
7.3.2.21 Pending Timeout .....	83
7.3.2.22 IEEE 1588 .....	83
7.3.2.23 IEEE 1588 Clock Accuracy .....	83
7.3.2.24 IEEE 1588 Status .....	84
7.3.2.25 CCP .....	84
7.3.2.26 MCP Host Port .....	85
7.3.2.27 Message Channel Destination Address .....	85
7.3.2.28 Message Channel Transmission Timeout .....	86
7.3.2.29 Message Channel Retry Count .....	86
7.3.2.30 Message Channel Source Port .....	86
7.3.2.31 Stream Channel Selector .....	86
7.3.2.32 SCCFG Unconditional Streaming .....	87
7.3.2.33 Gev SCCFG Extended Chunk Data .....	87
7.3.2.34 SCP Direction .....	87
7.3.2.35 SCP Interface Index .....	88
7.3.2.36 SCP Host Port .....	88
7.3.2.37 SCPS Fire Test Packet .....	88
7.3.2.38 SCPS Do Not Fragment .....	89
7.3.2.39 SCPS Big Endian .....	89
7.3.2.40 SCPS Packet Size .....	89
7.3.2.41 Stream Channel Packet Delay .....	89
7.3.2.42 Stream Channel Destination Address .....	90
7.3.2.43 Stream Channel Source Port .....	90
7.3.2.44 IEEE 1588 Mode .....	90
<b>8 Sequencer Control .....</b>	<b>92</b>
<b>8.1 Sequenced Feature Settings .....</b>	<b>92</b>
8.1.1 Sequencer Configuration .....	93
8.1.2 Sequencer Execution .....	94
8.1.3 Sequencer Usage Example - Simple features change while acquiring images .....	95
<b>8.2 Summary Table .....</b>	<b>96</b>



<b>8.3 Sequencer Control Features</b> .....	<b>97</b>
<b>8.3.1 Sequencer Mode</b> .....	<b>97</b>
<b>8.3.2 Sequencer Configuration Mode</b> .....	<b>98</b>
<b>8.3.3 Sequencer Configuration Valid</b> .....	<b>98</b>
<b>8.3.4 Sequencer Feature Selector</b> .....	<b>99</b>
<b>8.3.5 Sequencer Feature Enable</b> .....	<b>99</b>
<b>8.3.6 Sequencer Set Start</b> .....	<b>99</b>
<b>8.3.7 Sequencer Set Active</b> .....	<b>100</b>
<b>8.3.8 Sequencer Set Selector</b> .....	<b>100</b>
<b>8.3.9 Sequencer Set Valid</b> .....	<b>100</b>
<b>8.3.10 Sequencer Set Save</b> .....	<b>101</b>
<b>8.3.11 Sequencer Set Load</b> .....	<b>101</b>
<b>8.3.12 Sequencer Path Selector</b> .....	<b>101</b>
<b>8.3.13 Sequencer Trigger Source</b> .....	<b>102</b>
<b>8.3.14 Sequencer Trigger Activation</b> .....	<b>102</b>
<b>8.3.15 Sequencer Set Next</b> .....	<b>103</b>
<b>9 Color Transformation Control</b> .....	<b>104</b>
<b>9.1 Summary Table</b> .....	<b>104</b>
<b>9.2 Color Transformation Control Features</b> .....	<b>105</b>
<b>9.2.1 Color Transformation Selector</b> .....	<b>105</b>
<b>9.2.2 Color Transformation Enable</b> .....	<b>106</b>
<b>9.2.3 Color Transformation Value Selector</b> .....	<b>106</b>
<b>9.2.4 Color Transformation Value</b> .....	<b>107</b>
<b>9.2.5 RGB Transform Light Source</b> .....	<b>107</b>
<b>9.2.6 Saturation Enable</b> .....	<b>108</b>
<b>9.2.7 Saturation</b> .....	<b>108</b>
<b>10 Auto Algorithm Control</b> .....	<b>110</b>
<b>10.1 Auto Exposure (AE)</b> .....	<b>110</b>
<b>10.1.1 Auto Exposure Features</b> .....	<b>110</b>
<b>10.1.1.1 Backlight Compensation</b> .....	<b>111</b>
<b>10.1.1.2 Excessive Frontlight Compensation</b> .....	<b>111</b>
<b>10.1.1.3 Normal Lighting</b> .....	<b>111</b>
<b>10.1.1.4 Average Metering</b> .....	<b>111</b>
<b>10.1.1.5 Spot Metering</b> .....	<b>111</b>
<b>10.1.1.6 Partial Metering</b> .....	<b>111</b>



10.2 Auto White Balance .....	112
10.3 Summary Table .....	112
10.4 Auto Algorithm Control Features .....	115
10.4.1 ROI Selector .....	115
10.4.2 ROI Enable .....	116
10.4.3 ROI Offset X .....	116
10.4.4 ROI Offset Y .....	116
10.4.5 ROI Width .....	117
10.4.6 ROI Height .....	117
10.4.7 White Balance Auto Profile .....	117
10.4.8 White Balance Auto Lower Limit .....	118
10.4.9 White Balance Auto Upper Limit .....	118
10.4.10 White Balance Auto Damping .....	118
10.4.11 Target Grey Value Auto .....	119
10.4.12 Target Grey Value .....	119
10.4.13 Lighting Mode .....	119
10.4.14 Metering Mode .....	120
10.4.15 Exposure Time Lower Limit .....	121
10.4.16 Exposure Time Upper Limit .....	121
10.4.17 Gain Lower Limit .....	121
10.4.18 Gain Upper Limit .....	122
10.4.19 Target Grey Value Lower Limit .....	122
10.4.20 Target Grey Value Upper Limit .....	122
10.4.21 EV Compensation .....	123
10.4.22 Auto Exposure Damping .....	123
10.4.23 Auto Exposure Control Priority .....	123
11 Defective Pixel Correction .....	125
11.1 Modifying the List of Defective Pixels .....	125
11.1.1 Example: Adding a location to the Defective Pixel Table .....	125
11.2 Summary Table .....	126
11.3 Defective Pixel Correction Features .....	127
11.3.1 Defect Correct Static Enable .....	127
11.3.2 Defect Correction Mode .....	127
11.3.3 Defect Table Pixel Count .....	128
11.3.4 Defect Table Index .....	128

11.3.5 Defect X Coordinate .....	128
11.3.6 Defect Y Coordinate .....	129
11.3.7 Defect Table Apply .....	129
11.3.8 Defect Table Save .....	129
11.3.9 Defect Table Factory Restore .....	130
12 User Set Control .....	131
12.1 Types of User Sets .....	131
12.2 Start-up User Set .....	131
12.3 User Set Managed Features .....	131
12.4 User Set Conversion .....	131
12.5 Summary Table .....	132
12.6 User Set Control Features .....	132
12.6.1 User Set Selector .....	132
12.6.2 User Set Load .....	133
12.6.3 User Set Save .....	133
12.6.4 User Set Default .....	133
12.6.5 User Set Feature Selector .....	134
12.6.6 User Set Feature Enable .....	141
13 Chunk Data Control .....	142
13.1 Summary Table .....	142
13.2 Chunk Data Control Features .....	143
13.2.1 Chunk Mode Active .....	144
13.2.2 Chunk Selector .....	144
13.2.3 Chunk Enable .....	145
13.2.4 Chunk Image .....	145
13.2.5 Image CRC .....	145
13.2.6 Chunk Frame ID .....	146
13.2.7 Chunk Offset X .....	146
13.2.8 Chunk Offset Y .....	146
13.2.9 Chunk Width .....	147
13.2.10 Chunk Height .....	147
13.2.11 Chunk Pixel Format .....	147
13.2.12 Chunk Exposure Time .....	148
13.2.13 Chunk Gain Selector .....	148
13.2.14 Chunk Gain .....	149

13.2.15 Chunk Black Level Selector .....	149
13.2.16 Chunk Black Level .....	149
13.2.17 Chunk Timestamp .....	150
13.2.18 Chunk Sequencer Set Active .....	150
13.2.19 Chunk Serial Data Length .....	150
13.2.20 Chunk Serial Data .....	151
13.2.21 Chunk Serial Receive Overflow .....	151
<b>14 LUT Control .....</b>	<b>152</b>
14.1 Summary Table .....	152
14.2 LUT Control Features .....	153
14.2.1 LUT Selector .....	153
14.2.2 LUT Enable .....	153
14.2.3 LUT Index .....	154
14.2.4 LUT Value .....	154
14.2.5 LUT Value All .....	154
<b>15 Event Control .....</b>	<b>155</b>
15.0.1 Event Features .....	155
15.1 Summary Table .....	155
15.2 Event Control Features .....	155
15.2.1 Event Selector .....	156
15.2.2 Event Notification .....	156
15.2.3 Event Exposure End Data .....	156
15.2.4 Event Error Data .....	157
15.2.5 Event Serial Port Receive Data .....	157
15.2.6 Event Test Data .....	157
15.3 Event Exposure End Data .....	158
15.3.1 Summary Table .....	158
15.3.2 Event Exposure End Data Features .....	158
15.3.2.1 Event Exposure End .....	158
15.3.2.2 Event Exposure End Timestamp .....	158
15.3.2.3 Event Exposure End Frame ID .....	159
15.4 Event Error Data .....	159
15.4.1 Summary Table .....	159
15.4.2 Event Error Data Features .....	159
15.4.2.1 Event Error .....	159

15.4.2.2 Event Error Timestamp .....	160
15.4.2.3 Event Error Frame ID .....	160
15.4.2.4 Event Error Code .....	160
15.5 Event Serial Port Receive Data .....	161
15.5.1 Summary Table .....	161
15.5.2 Event Serial Port Receive Data Features .....	161
15.5.2.1 Event Serial Port Receive .....	161
15.5.2.2 Event Serial Port Receive Timestamp .....	162
15.5.2.3 Event Serial Data .....	162
15.5.2.4 Event Serial Data Length .....	162
15.5.2.5 Event Serial Receive Overflow .....	163
15.6 Event Test Data .....	163
15.6.1 Summary Table .....	163
15.6.2 Event Test Data Features .....	163
15.6.2.1 Event Test .....	163
15.6.2.2 Event Test Timestamp .....	164
16 Counter And Timer Control .....	165
16.1 Summary Table .....	166
16.2 Counter And Timer Control Features .....	167
16.2.1 Counter Selector .....	167
16.2.2 Counter Event Source .....	168
16.2.3 Counter Event Activation .....	169
16.2.4 Counter Duration .....	169
16.2.5 Counter Value .....	170
16.2.6 Counter Value At Reset .....	170
16.2.7 Counter Trigger Source .....	170
16.2.8 Counter Trigger Activation .....	171
16.2.9 Counter Reset Source .....	172
16.2.10 Counter Reset Activation .....	173
16.2.11 Counter Status .....	173
16.2.12 Counter Delay .....	174
17 Test Control .....	175
17.1 Summary Table .....	175
17.2 Test Control Features .....	175
17.2.1 Test Event Generate .....	175



17.2.2 Test 0001 .....	175
<b>18 Logic Block Control .....</b>	<b>177</b>
18.1 Summary Table .....	178
<b>18.2 Logic Block Control Features .....</b>	<b>178</b>
18.2.1 Logic Block Selector .....	179
18.2.2 Logic Block LUT Selector .....	179
18.2.3 Logic Block LUT Input Selector .....	179
18.2.4 Logic Block LUT Input Source .....	180
18.2.5 Logic Block LUT Input Activation .....	181
18.2.6 Logic Block LUT Output Value All .....	182
18.2.7 Logic Block LUT Row Index .....	182
18.2.8 Logic Block LUT Output Value .....	182
<b>19 Digital IO Control .....</b>	<b>183</b>
19.1 Summary Table .....	185
<b>19.2 Digital IO Control Features .....</b>	<b>186</b>
19.2.1 Line Selector .....	187
19.2.2 Line Mode .....	187
19.2.3 3.3V Enable .....	188
19.2.4 Line Inverter .....	188
19.2.5 Line Status .....	188
19.2.6 Line Status All .....	188
19.2.7 Input filter Selector .....	189
19.2.8 Line Filter Width .....	189
19.2.9 Line Source .....	190
19.2.10 Line Format .....	191
19.2.11 Exposure Active Mode .....	191
19.2.12 User Output Selector .....	191
19.2.13 User Output Value .....	192
19.2.14 User Output Value All .....	192
<b>20 Serial Port Control .....</b>	<b>194</b>
20.1 Serial Port .....	194
20.2 Summary Table .....	194
<b>20.3 Serial Port Control Features .....</b>	<b>195</b>
20.3.1 Serial Port Selector .....	195
20.3.2 Serial Port Source .....	196



20.3.3 Serial Port Baud Rate .....	196
20.3.4 Serial Port Data Bits .....	197
20.3.5 Serial Port Stop Bits .....	198
20.3.6 Serial Port Parity .....	198
20.3.7 Transmit Queue Max Character Count .....	199
20.3.8 Transmit Queue Current Character Count .....	199
20.3.9 Receive Queue Max Character Count .....	199
20.3.10 Receive Queue Current Character Count .....	200
20.3.11 Receive Queue Clear .....	200
20.3.12 Receive Framing Error Count .....	200
20.3.13 Receive Parity Error Count .....	201
<b>20 File Access .....</b>	<b>202</b>
20.1 File Access .....	202
20.2 Summary Table .....	202
20.3 File Access Features .....	203
20.3.1 File Selector .....	203
20.3.2 File Operation Selector .....	203
20.3.3 File Operation Execute .....	204
20.3.4 File Open Mode .....	204
20.3.5 File Access Buffer .....	205
20.3.6 File Access Offset .....	205
20.3.7 File Access Length .....	205
20.3.8 File Operation Status .....	206
20.3.9 File Operation Result .....	206
20.3.10 File Size .....	206
<b>21 Transfer Control .....</b>	<b>208</b>
21.1 Summary Table .....	209
21.2 Transfer Control Features .....	210
21.2.1 Transfer Control Mode .....	210
21.2.2 Transfer Operation Mode .....	210
21.2.3 Transfer Block Count .....	211
21.2.4 Transfer Queue Max Block Count .....	211
21.2.5 Transfer Queue Current Block Count .....	211
21.2.6 Transfer Queue Overflow Count .....	212
21.2.7 Transfer Queue Mode .....	212



21.2.8 Transfer Start .....	212
21.2.9 Transfer Stop .....	213
Contacting Us .....	214



# 1 Oryx Technical Reference

Welcome to the Oryx camera. We offer a number of resources to assist you with the Oryx.

- **Release Notes**—information about the current firmware release including feature additions or changes, bug fixes, and known issues.
- **Specifications**—information about the camera model as it performs with the current firmware.
- **Getting Started**—quick start guide for installing the camera and software.
- **Installation Guide**—information about installing the camera and SDK, the physical interface and mechanical properties, troubleshooting and how to get help. This document is available as a PDF for download or as a webpage included in the firmware release package.
- **Technical Reference**—information about the features supported by the camera model with the current firmware, including: image format control, acquisition control, sequencing, binning/decimation, and others. This document is available as a PDF for download or as a webpage included in the firmware release package.
- **Firmware**—programming inserted into the programmable ROM of the camera that can be updated in-field. New firmware packages are available for download and include both the firmware file and documentation.
- **Spinnaker SDK**—software development kit that provides GenICam-compliant controls to create applications for the camera. Spinnaker is available for download. Each installation includes API documentation for C, C++, and C#.

Our website provides additional information in our [Knowledge Base](#) and [Technical Application Note](#) library. As well, the [Downloads](#) site is the portal to access documentation and firmware updates.

---

## 2 ORX-10G-123S6 Specifications

### 2.1 General

	ORX-10G-123S6M	ORX-10G-123S6C
Firmware Version	1610.1.267.0	1610.1.267.0
Resolution	4096 x 3000	4096 x 3000
Frame Rate	68 FPS	68 FPS
Megapixels	12.3 MP	12.3 MP
Chroma	Mono	Color
Sensor	Sony IMX253, CMOS, 1.1"	Sony IMX253, CMOS, 1.1"
Readout Method	Global shutter	Global shutter
Pixel Size	3.45 $\mu$ m	3.45 $\mu$ m
Lens Mount	C-mount	C-mount
ADC	8-bit / 10-bit / 12-bit	8-bit / 10-bit / 12-bit
Minimum Frame Rate*	1 FPS	1 FPS
Gain Range*	0 to 47 dB	0 to 47 dB
Exposure Range*	5 $\mu$ s to 30 s	5 $\mu$ s to 30 s
Acquisition Modes	Continuous, Single Frame, Multi Frame	Continuous, Single Frame, Multi Frame
Partial Image Modes	Pixel binning, decimation, ROI	Pixel binning, decimation, ROI
Image Processing	Gamma, lookup table, pixel correction, target grey value, and sharpness	Color correction matrix, gamma, lookup table, pixel correction, white balance, target grey value, saturation, and sharpness
Sequencer	Up to 8 sets using 2 features, exposure and gain	Up to 8 sets using 2 features, exposure and gain
Image Buffer	240 MB, maximum 4 images	240 MB, maximum 4 images
PTP1588 Support	Yes	Yes
User Sets	2 user configuration sets for custom camera settings	2 user configuration sets for custom camera settings
Flash Memory	4 MB non-volatile memory	4 MB non-volatile memory
Opto-isolated I/O	2 input, 2 output	2 input, 2 output
Non-isolated I/O	2 bi-directional	2 bi-directional
Serial Port	1 (over non-isolated I/O)	1 (over non-isolated I/O)
Auxiliary Output	3.3 V, 120 mA maximum	3.3 V, 120 mA maximum
Interface	10 GigE	10 GigE
Power Requirements	Externally powered over GPIO (12 - 24 V)	Externally powered over GPIO (12 - 24 V)
Power Consumption	Maximum: 15 W, Nominal: 11 W	Maximum: 15 W, Nominal: 11 W
Dimensions/Mass	60 mm x 60 mm x 100 mm /	60 mm x 60 mm x 100 mm / 500 g

	ORX-10G-123S6M	ORX-10G-123S6C
	500 g	
Machine Vision Standard	GigE Vision v1.2	GigE Vision v1.2
Compliance	CE, FCC, KCC, RoHS, REACH	CE, FCC, KCC, RoHS, REACH
Temperature	Operating: 0°C to 50°C Storage: -30°C to 60°C	Operating: 0°C to 50°C Storage: -30°C to 60°C
Humidity	Operating: 20% to 80% (no condensation) Storage: 20% to 95% (no condensation)	Operating: 20% to 80% (no condensation) Storage: 20% to 95% (no condensation)
Warranty	3 years	3 years

\*Ranges are the same in binning and no binning modes.

## 2.2 ORX-10G-123S6M Supported Pixel Formats

8-bit	12-bit	16-bit
Mono8	Mono12Packed	Mono16
	Mono12p	

## 2.3 ORX-10G-123S6M Frame Rates

Width	Height	8-bit	12-bit	16-bit	ISP	Binning Horizontal	Binning Vertical	Decimation Horizontal	Decimation Vertical	ADC
4096	3000	68	49	33	Off	No binning	No binning	No decimation	No decimation	8-bit
1920	1080	182	182	182	Off	No binning	No binning	No decimation	No decimation	8-bit
1080	1920	105	105	105	Off	No binning	No binning	No decimation	No decimation	8-bit
1280	720	265	265	265	Off	No binning	No binning	No decimation	No decimation	8-bit
720	1280	155	155	155	Off	No binning	No binning	No decimation	No decimation	8-bit
640	480	382	382	382	Off	No binning	No binning	No decimation	No decimation	8-bit
480	640	295	295	295	Off	No binning	No binning	No decimation	No decimation	8-bit
2048	1500	133	133	133	Off	No binning	No binning	2x Sensor	2x Sensor	8-bit
4096	3000	39	39	39	On	No binning	No binning	No decimation	No decimation	8-bit
1920	1080	104	104	104	On	No binning	No binning	No decimation	No decimation	8-bit
1080	1920	60	60	60	On	No binning	No binning	No decimation	No decimation	8-bit

Width	Height	8-bit	12-bit	16-bit	ISP	Binning Horizontal	Binning Vertical	Decimation Horizontal	Decimation Vertical	ADC
1280	720	153	153	153	On	No binning	No binning	No decimation	No decimation	8-bit
720	1280	89	89	89	On	No binning	No binning	No decimation	No decimation	8-bit
640	480	220	220	220	On	No binning	No binning	No decimation	No decimation	8-bit
480	640	170	170	170	On	No binning	No binning	No decimation	No decimation	8-bit
2048	1500	39	39	39	On	2x ISP	2x ISP	No decimation	No decimation	8-bit
1024	750	39	39	39	On	4x ISP	4x ISP	No decimation	No decimation	8-bit
1024	750	76	76	76	On	2x Sensor/2x ISP	2x Sensor/2x ISP	No decimation	No decimation	8-bit
4096	3000	64	51	34	Off	No binning	No binning	No decimation	No decimation	10-bit
1920	1080	172	172	172	Off	No binning	No binning	No decimation	No decimation	10-bit
1080	1920	99	99	99	Off	No binning	No binning	No decimation	No decimation	10-bit
1280	720	251	251	251	Off	No binning	No binning	No decimation	No decimation	10-bit
720	1280	146	146	146	Off	No binning	No binning	No decimation	No decimation	10-bit
640	480	362	362	362	Off	No binning	No binning	No decimation	No decimation	10-bit
480	640	280	280	280	Off	No binning	No binning	No decimation	No decimation	10-bit
2048	1500	126	126	126	Off	No binning	No binning	2x Sensor	2x Sensor	10-bit
4096	3000	39	39	39	On	No binning	No binning	No decimation	No decimation	10-bit
1920	1080	104	104	104	On	No binning	No binning	No decimation	No decimation	10-bit
1080	1920	60	60	60	On	No binning	No binning	No decimation	No decimation	10-bit
1280	720	153	153	153	On	No binning	No binning	No decimation	No decimation	10-bit
720	1280	89	89	89	On	No binning	No binning	No decimation	No decimation	10-bit
640	480	220	220	220	On	No binning	No binning	No decimation	No decimation	10-bit
480	640	170	170	170	On	No binning	No binning	No decimation	No decimation	10-bit
2048	1500	39	39	39	On	2x ISP	2x ISP	No decimation	No decimation	10-bit
1024	750	39	39	39	On	4x ISP	4x ISP	No decimation	No decimation	10-bit

Width	Height	8-bit	12-bit	16-bit	ISP	Binning Horizontal	Binning Vertical	Decimation Horizontal	Decimation Vertical	ADC
1024	750	76	76	76	On	2x Sensor/2x ISP	2x Sensor/2x ISP	No decimation	No decimation	10-bit
4096	3000	46	46	39	Off	No binning	No binning	No decimation	No decimation	12-bit
1920	1080	124	124	124	Off	No binning	No binning	No decimation	No decimation	12-bit
1080	1920	71	71	71	Off	No binning	No binning	No decimation	No decimation	12-bit
1280	720	181	181	181	Off	No binning	No binning	No decimation	No decimation	12-bit
720	1280	105	105	105	Off	No binning	No binning	No decimation	No decimation	12-bit
640	480	261	261	261	Off	No binning	No binning	No decimation	No decimation	12-bit
480	640	201	201	201	Off	No binning	No binning	No decimation	No decimation	12-bit
2048	1500	90	90	90	Off	No binning	No binning	2x Sensor	2x Sensor	12-bit
4096	3000	39	39	39	On	No binning	No binning	No decimation	No decimation	12-bit
1920	1080	104	104	104	On	No binning	No binning	No decimation	No decimation	12-bit
1080	1920	60	60	60	On	No binning	No binning	No decimation	No decimation	12-bit
1280	720	153	153	153	On	No binning	No binning	No decimation	No decimation	12-bit
720	1280	89	89	89	On	No binning	No binning	No decimation	No decimation	12-bit
640	480	220	220	220	On	No binning	No binning	No decimation	No decimation	12-bit
480	640	170	170	170	On	No binning	No binning	No decimation	No decimation	12-bit
2048	1500	39	39	39	On	2x ISP	2x ISP	No decimation	No decimation	12-bit
1024	750	39	39	39	On	4x ISP	4x ISP	No decimation	No decimation	12-bit
1024	750	76	76	76	On	2x Sensor/2x ISP	2x Sensor/2x ISP	No decimation	No decimation	12-bit

## 2.4 ORX-10G-123S6C Supported Pixel Formats

8-bit	12-bit	16-bit	24-bit	32-bit
Mono8	Mono12Packed	Mono16	RGB8Packed	BGRa8

8-bit	12-bit	16-bit	24-bit	32-bit
BayerRG8	BayerRG12Packed	BayerRG16	YUV444Packed	
	Mono12p	YUV422Packed	YCbCr8	
	BayerRG12p	YCbCr422_8	BGR8	
	YUV411Packed			
	YCbCr411_8			

## 2.5 ORX-10G-123S6C Frame Rates

Width	Height	8-bit	12-bit	16-bit	24-bit	32-bit	ISP	Binning Horizontal	Binning Vertical	Decimation Horizontal	Decimation Vertical	ADC
4096	3000	68	49	33	N/A*	N/A*	Off	No binning	No binning	No decimation	No decimation	8-bit
1920	1080	182	182	182	N/A*	N/A*	Off	No binning	No binning	No decimation	No decimation	8-bit
1080	1920	105	105	105	N/A*	N/A*	Off	No binning	No binning	No decimation	No decimation	8-bit
1280	720	265	265	265	N/A*	N/A*	Off	No binning	No binning	No decimation	No decimation	8-bit
720	1280	155	155	155	N/A*	N/A*	Off	No binning	No binning	No decimation	No decimation	8-bit
640	480	382	382	382	N/A*	N/A*	Off	No binning	No binning	No decimation	No decimation	8-bit
480	640	295	295	295	N/A*	N/A*	Off	No binning	No binning	No decimation	No decimation	8-bit
2048	1500	133	133	133	N/A*	N/A*	Off	No binning	No binning	2x Sensor	2x Sensor	8-bit
4096	3000	39	39	39	23	16	On	No binning	No binning	No decimation	No decimation	8-bit
1920	1080	104	104	104	104	104	On	No binning	No binning	No decimation	No decimation	8-bit
1080	1920	60	60	60	60	60	On	No binning	No binning	No decimation	No decimation	8-bit
1280	720	153	153	153	153	153	On	No binning	No binning	No decimation	No decimation	8-bit
720	1280	89	89	89	89	89	On	No binning	No binning	No decimation	No decimation	8-bit
640	480	220	220	220	220	220	On	No binning	No binning	No decimation	No decimation	8-bit
480	640	170	170	170	170	170	On	No binning	No binning	No decimation	No decimation	8-bit
2048	1500	39	39	39	39	39	On	2x ISP	2x ISP	No decimation	No decimation	8-bit
1024	750	39	39	39	39	39	On	4x ISP	4x ISP	No decimation	No decimation	8-bit

Width	Height	8-bit	12-bit	16-bit	24-bit	32-bit	ISP	Binning Horizontal	Binning Vertical	Decimation Horizontal	Decimation Vertical	ADC
4096	3000	64	51	34	N/A*	N/A*	Off	No binning	No binning	No decimation	No decimation	10-bit
1920	1080	172	172	172	N/A*	N/A*	Off	No binning	No binning	No decimation	No decimation	10-bit
1080	1920	99	99	99	N/A*	N/A*	Off	No binning	No binning	No decimation	No decimation	10-bit
1280	720	251	251	251	N/A*	N/A*	Off	No binning	No binning	No decimation	No decimation	10-bit
720	1280	146	146	146	N/A*	N/A*	Off	No binning	No binning	No decimation	No decimation	10-bit
640	480	362	362	362	N/A*	N/A*	Off	No binning	No binning	No decimation	No decimation	10-bit
480	640	280	280	280	N/A*	N/A*	Off	No binning	No binning	No decimation	No decimation	10-bit
2048	1500	126	126	126	N/A*	N/A*	Off	No binning	No binning	2x Sensor	2x Sensor	10-bit
4096	3000	39	39	39	23	16	On	No binning	No binning	No decimation	No decimation	10-bit
1920	1080	104	104	104	104	104	On	No binning	No binning	No decimation	No decimation	10-bit
1080	1920	60	60	60	60	60	On	No binning	No binning	No decimation	No decimation	10-bit
1280	720	153	153	153	153	153	On	No binning	No binning	No decimation	No decimation	10-bit
720	1280	89	89	89	89	89	On	No binning	No binning	No decimation	No decimation	10-bit
640	480	220	220	220	220	220	On	No binning	No binning	No decimation	No decimation	10-bit
480	640	170	170	170	170	170	On	No binning	No binning	No decimation	No decimation	10-bit
2048	1500	39	39	39	39	39	On	2x ISP	2x ISP	No decimation	No decimation	10-bit
1024	750	39	39	39	39	39	On	4x ISP	4x ISP	No decimation	No decimation	10-bit
4096	3000	46	46	39	N/A*	N/A*	Off	No binning	No binning	No decimation	No decimation	12-bit
1920	1080	124	124	124	N/A*	N/A*	Off	No binning	No binning	No decimation	No decimation	12-bit
1080	1920	71	71	71	N/A*	N/A*	Off	No binning	No binning	No decimation	No decimation	12-bit
1280	720	181	181	181	N/A*	N/A*	Off	No binning	No binning	No decimation	No decimation	12-bit
720	1280	105	105	105	N/A*	N/A*	Off	No binning	No binning	No decimation	No decimation	12-bit
640	480	261	261	261	N/A*	N/A*	Off	No binning	No	No decimation	No	12-bit

Width	Height	8-bit	12-bit	16-bit	24-bit	32-bit	ISP	Binning Horizontal	Binning Vertical	Decimation Horizontal	Decimation Vertical	ADC
									binning		decimation	bit
480	640	201	201	201	N/A*	N/A*	Off	No binning	No binning	No decimation	No decimation	12-bit
2048	1500	90	90	90	N/A*	N/A*	Off	No binning	No binning	2x Sensor	2x Sensor	12-bit
4096	3000	39	39	39	23	16	On	No binning	No binning	No decimation	No decimation	12-bit
1920	1080	104	104	104	104	104	On	No binning	No binning	No decimation	No decimation	12-bit
1080	1920	60	60	60	60	60	On	No binning	No binning	No decimation	No decimation	12-bit
1280	720	153	153	153	153	153	On	No binning	No binning	No decimation	No decimation	12-bit
720	1280	89	89	89	89	89	On	No binning	No binning	No decimation	No decimation	12-bit
640	480	220	220	220	220	220	On	No binning	No binning	No decimation	No decimation	12-bit
480	640	170	170	170	170	170	On	No binning	No binning	No decimation	No decimation	12-bit
2048	1500	39	39	39	39	39	On	2x ISP	2x ISP	No decimation	No decimation	12-bit
1024	750	39	39	39	39	39	On	4x ISP	4x ISP	No decimation	No decimation	12-bit

\*ISP Off is only supported with uninterpolated formats (Mono and Bayer). YUV and RGB formats are not supported.



## 3 Acquisition Control

### 3.1 Acquisition and Frame Rate

There are three acquisition modes:

**Continuous** - acquires images continuously. This is the default mode.

**Multi Frame** - acquires a specified number of images before stopping acquisition.

**Single Frame** - acquires 1 image before stopping acquisition.

Use [AcquisitionMode](#) to select your mode. If you select MultiFrame, use [AcquisitionFrameCount](#) to specify the number of images to acquire.

Use [AcquisitionStart](#) and [AcquisitionStop](#) to start and stop acquiring images with the selected mode.

The Acquisition Frame Rate can be manually or automatically controlled. Use [AcquisitionFrameRateEnable](#) to set this On (manual control) or Off (automatic control). By default, this is Off. If you select manual control, use [AcquisitionFrameRate](#) to specify a frame rate.

The [ResultingFrameRate](#) reports the actual frame rate at which the camera is streaming. If this does not equal the Acquisition Frame Rate it is because the Exposure Time is greater than the frame time.

### 3.2 Exposure Time Modes

There are two exposure time modes:

**Timed** - exposure time is a specified value. This is the default mode.

**TriggerWidth** - exposure time is controlled by the trigger signal.

Use [ExposureMode](#) to make a selection.

When ExposureMode is set to Timed, exposure time can be manually or automatically controlled.

For manual control, set [ExposureAuto](#) to Off. Use the [ExposureTime](#) control to set the exposure time in microseconds.

For automatic control, set ExposureAuto to Once or Continuous. The camera automatically adjusts the exposure to maximize the dynamic range. Once briefly enables automatic exposure to adapt the device and then sets exposure to manual control (Off). Continuous constantly adapts the device. Continuous is the default setting.

Note: For the [Auto Exposure feature](#), gain and/or exposure time must be set to Continuous.

#### 3.2.1 Trigger Features

Triggering allows you to acquire images at specific times when an event occurs. Triggering works with the acquisition modes and settings. By default, triggering is set to Off. To enable triggering, set [TriggerMode](#) to On.

Trigger Type - three options to control the start of triggering. Use [TriggerSelector](#) to select an option.

**Acquisition Start** - A trigger starts acquisition in the selected AcquisitionMode.

In Single Frame mode, the trigger acquires one image.

In Multi Frame mode, the trigger acquires the specified number of images.

In Continuous mode, the trigger acquires images until you stop acquisition.

**Frame Start** - A trigger is required for each individual image that is acquired.

In Single Frame mode, the trigger acquires one image. For each subsequent trigger you first must use AcquisitionStart to receive more images.

In Multi Frame mode, the trigger acquires the specified number of images. For each subsequent trigger you first must use AcquisitionStart to receive more images.

In Continuous mode, the trigger acquires one image. You do not have to start acquisition again for subsequent triggers.

**Frame Burst Start** - A trigger acquires a specified number of images. You do not have to start acquisition again for subsequent triggers. This mode is primarily used in Continuous mode, as Single Frame and Multi Frame settings overwrite the burst count. Use [AcquisitionBurstFrameCount](#) to specify the number of images to be acquired.

In Single Frame mode, the trigger acquires one image.

In Multi Frame mode, the trigger acquires the number of images specified in AcquisitionFrameCount.

In Continuous mode, the trigger acquires the number of images specified in AcquisitionBurstFrameCount.

**Trigger Source** - Use [TriggerSource](#) to specify the source that can signal the acquisition to acquire images. A trigger source can be one of the physical Line Inputs, User Outputs, Counters, Logic Blocks, and Software.

**Trigger Activation** - Use [TriggerActivation](#) to specify what voltage level or transition that activates a trigger. Trigger activation can be Level Low, Level High, Falling Edge, Rising Edge, or Any Edge.

**Trigger Overlap** - Use [TriggerOverlap](#) to specify whether a trigger responds while the readout of a previously acquired image is still occurring. There are two options: When set to Off, a trigger is disregarded during readout. When set to ReadOut, a trigger acquires another image during readout.

**Trigger Delay** - Use [TriggerDelay](#) to specify the time in microseconds between when the camera receives a trigger and when exposure begins for the image.

**Trigger Software** - If your trigger source is set to Software, use [TriggerSoftware](#) to perform a software trigger.

## 3.3 Summary Table

Name	Interface	Access	Visibility	Description
<a href="#">Acquisition Mode</a>	IEnumeration		Beginner	Sets the acquisition mode of the device. Continuous: acquires images continuously. Multi Frame: acquires a specified number of images before stopping acquisition. Single Frame: acquires 1 image before stopping acquisition.

Name	Interface	Access	Visibility	Description
<a href="#">Acquisition Start</a>	ICommand		Beginner	This command starts the acquisition of images.
<a href="#">Acquisition Stop</a>	ICommand		Beginner	This command stops the acquisition of images.
<a href="#">Acquisition Frame Count</a>	Integer		Beginner	Number of images to acquire during a multi frame acquisition.
<a href="#">Acquisition Burst Frame Count</a>	Integer		Beginner	This feature is used only if the FrameBurstStart trigger is enabled and the FrameBurstEnd trigger is disabled. Note that the total number of frames captured is also conditioned by AcquisitionFrameCount if AcquisitionMode is MultiFrame and ignored if AcquisitionMode is Single.
<a href="#">Exposure Mode</a>	IEnumeration	RW	Beginner	Sets the operation mode of the Exposure.
<a href="#">Exposure Time</a>	IFloat		Beginner	Exposure time in microseconds when Exposure Mode is Timed.
<a href="#">Exposure Auto</a>	IEnumeration		Beginner	Sets the automatic exposure mode
<a href="#">Acquisition Frame Rate</a>	IFloat		Beginner	User controlled acquisition frame rate in Hertz
<a href="#">Resulting Frame Rate</a>	IFloat	RO	Beginner	Resulting frame rate in Hertz. If this does not equal the Acquisition Frame Rate it is because the Exposure Time is greater than the frame time.
<a href="#">Acquisition Frame Rate Enable</a>	IBoolean	RW	Beginner	If enabled, AcquisitionFrameRate can be used to manually control the frame rate.
<a href="#">Acquisition Line Rate</a>	IFloat		Beginner	Controls the rate (in Hertz) at which the Lines in a Frame are captured.
<a href="#">Trigger Selector</a>	IEnumeration	RW	Beginner	Selects the type of trigger to configure.
<a href="#">Trigger Mode [Trigger Selector]</a>	IEnumeration	RW	Beginner	Controls whether or not trigger is active.
<a href="#">Trigger Software [Trigger Selector]</a>	ICommand	WO	Beginner	Generates an internal trigger if Trigger Source is set to Software.

Name	Interface	Access	Visibility	Description
<a href="#">Trigger Source [Trigger Selector]</a>	IEnumeration	RW	Beginner	Specifies the internal signal or physical input line to use as the trigger source.
<a href="#">Trigger Activation [Trigger Selector]</a>	IEnumeration	RW	Beginner	Specifies the activation mode of the trigger.
<a href="#">Trigger Overlap [Trigger Selector]</a>	IEnumeration	RW	Beginner	Specifies the overlap mode of the trigger.
<a href="#">Trigger Delay [Trigger Selector]</a>	IFloat		Expert	Specifies the delay in microseconds ( $\mu$ s) to apply after the trigger reception before activating it.
<a href="#">Sensor Shutter Mode</a>	IEnumeration	RW	Guru	Sets the shutter mode of the device.

## 3.4 Acquisition Control Features

### 3.4.1 Acquisition Mode

Sets the acquisition mode of the device. Continuous: acquires images continuously. Multi Frame: acquires a specified number of images before stopping acquisition. Single Frame: acquires 1 image before stopping acquisition.

Property	Value
<b>Name</b>	AcquisitionMode
<b>Interface</b>	IEnumeration
<b>Access</b>	
<b>Visibility</b>	Beginner

#### Enumeration Values

Continuous

**Enumeration Values**

SingleFrame

MultiFrame

### 3.4.2 Acquisition Start

This command starts the acquisition of images.

Property	Value
Name	AcquisitionStart
Interface	ICommand
Access	
Visibility	Beginner

### 3.4.3 Acquisition Stop

This command stops the acquisition of images.

Property	Value
Name	AcquisitionStop
Interface	ICommand
Access	
Visibility	Beginner

### 3.4.4 Acquisition Frame Count

Number of images to acquire during a multi frame acquisition.

Property	Value
Name	AcquisitionFrameCount
Interface	Integer
Access	
Unit	
Visibility	Beginner

### 3.4.5 Acquisition Burst Frame Count

This feature is used only if the FrameBurstStart trigger is enabled and the FrameBurstEnd trigger is disabled. Note that the total number of frames captured is also conditioned by AcquisitionFrameCount if AcquisitionMode is MultiFrame and ignored if AcquisitionMode is Single.

Property	Value
<b>Name</b>	AcquisitionBurstFrameCount
<b>Interface</b>	Integer
<b>Access</b>	
<b>Unit</b>	
<b>Visibility</b>	Beginner

### 3.4.6 Exposure Mode

Sets the operation mode of the Exposure.

Property	Value
<b>Name</b>	ExposureMode
<b>Interface</b>	IEnumeration
<b>Access</b>	RW
<b>Visibility</b>	Beginner

#### Enumeration Values

Timed
TriggerWidth

### 3.4.7 Exposure Time

Exposure time in microseconds when Exposure Mode is Timed.

Property	Value
<b>Name</b>	ExposureTime
<b>Interface</b>	IFloat
<b>Access</b>	

Property	Value
Unit	us
Visibility	Beginner

### 3.4.8 Exposure Auto

Sets the automatic exposure mode

Property	Value
Name	ExposureAuto
Interface	IEnumeration
Access	
Visibility	Beginner

#### Enumeration Values

Off
Once
Continuous

### 3.4.9 Acquisition Frame Rate

User controlled acquisition frame rate in Hertz

Property	Value
Name	AcquisitionFrameRate
Interface	IFloat
Access	
Unit	Hz
Visibility	Beginner

### 3.4.10 Resulting Frame Rate

Resulting frame rate in Hertz. If this does not equal the Acquisition Frame Rate it is because the Exposure Time is greater than the frame time.

Property	Value
<b>Name</b>	AcquisitionResultingFrameRate
<b>Interface</b>	IFloat
<b>Access</b>	RO
<b>Unit</b>	Hz
<b>Visibility</b>	Beginner

### 3.4.11 Acquisition Frame Rate Enable

If enabled, AcquisitionFrameRate can be used to manually control the frame rate.

Property	Value
<b>Name</b>	AcquisitionFrameRateEnable
<b>Interface</b>	IBoolean
<b>Access</b>	RW
<b>Visibility</b>	Beginner

### 3.4.12 Acquisition Line Rate

Controls the rate (in Hertz) at which the Lines in a Frame are captured.

Property	Value
<b>Name</b>	AcquisitionLineRate
<b>Interface</b>	IFloat
<b>Access</b>	
<b>Unit</b>	Hz
<b>Visibility</b>	Beginner

### 3.4.13 Trigger Selector

Selects the type of trigger to configure.

Property	Value
<b>Name</b>	TriggerSelector



Property	Value
<b>Interface</b>	IEnumeration
<b>Access</b>	RW
<b>Visibility</b>	Beginner

**Enumeration Values**

AcquisitionStart
FrameStart
FrameBurstStart

### 3.4.14 Trigger Mode

Controls whether or not trigger is active.

Property	Value
<b>Name</b>	TriggerMode <a href="#">[Trigger Selector]</a>
<b>Interface</b>	IEnumeration
<b>Access</b>	RW
<b>Visibility</b>	Beginner

**Enumeration Values**

Off
On

### 3.4.15 Trigger Software

Generates an internal trigger if Trigger Source is set to Software.

Property	Value
<b>Name</b>	TriggerSoftware <a href="#">[Trigger Selector]</a>
<b>Interface</b>	ICommand
<b>Access</b>	WO
<b>Visibility</b>	Beginner

### 3.4.16 Trigger Source

Specifies the internal signal or physical input line to use as the trigger source.

Property	Value
<b>Name</b>	TriggerSource <a href="#">[Trigger Selector]</a>
<b>Interface</b>	IEnumeration
<b>Access</b>	RW
<b>Visibility</b>	Beginner

#### Enumeration Values

Software
Line0
Line1
Line2
Line3
Line4
Line5
Line6
UserOutput0
UserOutput1
UserOutput2
UserOutput3
Counter0Start
Counter1Start
Counter0End
Counter1End
LogicBlock0
LogicBlock1

### 3.4.17 Trigger Activation

Specifies the activation mode of the trigger.

Property	Value
<b>Name</b>	TriggerActivation <a href="#">[Trigger Selector]</a>
<b>Interface</b>	IEnumeration
<b>Access</b>	RW
<b>Visibility</b>	Beginner

#### Enumeration Values

LevelLow
LevelHigh
FallingEdge
RisingEdge
AnyEdge

### 3.4.18 Trigger Overlap

Specifies the overlap mode of the trigger.

Property	Value
<b>Name</b>	TriggerOverlap <a href="#">[Trigger Selector]</a>
<b>Interface</b>	IEnumeration
<b>Access</b>	RW
<b>Visibility</b>	Beginner

#### Enumeration Values

Off
ReadOut
PreviousFrame

### 3.4.19 Trigger Delay

Specifies the delay in microseconds ( $\mu$ s) to apply after the trigger reception before activating it.

Property	Value
<b>Name</b>	TriggerDelay <a href="#">[Trigger Selector]</a>
<b>Interface</b>	IFloat
<b>Access</b>	
<b>Unit</b>	us
<b>Visibility</b>	Expert

### 3.4.20 Sensor Shutter Mode

Sets the shutter mode of the device.

Property	Value
<b>Name</b>	SensorShutterMode
<b>Interface</b>	IEnumeration
<b>Access</b>	RW
<b>Visibility</b>	Guru

#### Enumeration Values

Global
--------

## 4 Analog Control

### 4.1 Gain

Gain is the amount of amplification that is applied to a pixel by the A/D converter. An increase in gain can result in a brighter image but also an increase in noise.

Gain can be manually or automatically controlled.

Use the [Gain Selector](#) to choose which gain to control. The All selection is a total amplification across all channels (or taps).

For manual control, set [GainAuto](#) to Off. Use the [Gain](#) control to set the amplification in dB.

For automatic control, set [GainAuto](#) to Once or Continuous. The camera automatically adjusts the gain to maximize the dynamic range. Once briefly enables automatic gain to adapt the device and then sets gain back to manual control (Off). Continuous constantly adapts the device.

Note: For the [Auto Exposure feature](#), gain and/or exposure time must be set to Once or Continuous.

### 4.2 Black Level

The Black Level feature controls the offset applied to the video signal. It determines the image average when there is no light reaching the sensor.

There are two methods of applying black level: Analog and Digital. The analog black level controls the offset applied during analog-to-digital (A/D) conversion. The digital black level is an offset applied after the image has been digitized.

The sum of the analog and digital black levels can be set and read by setting [Black Level Selector](#) to All and then using the [Black Level](#) feature to enter or view the percentage offset.

Only the total black level (All) can be set by the user. Based on the value of black level All, the analog and digital black levels are automatically set to achieve the requested total black level.

### 4.3 White Balance

White balance compensates for color shifts caused by different lighting conditions. White balance is specified as the gains of the Red and Blue channels relative to Green. For example, if the blue balance ratio is set to 1.5 then 50% more gain is applied to the blue channel than the green channel. White balance can be manually or automatically controlled.

For manual control, set [White Balance Auto](#) to Off. Use the [Balance Ratio Selector](#) to select either the Red or Blue channel. Use the [Balance Ratio](#) to specify a value for that channel. To disable white balance, set both red and blue balance ratios to 1.0.

For automatic control, set [White Balance Auto](#) to Once or Continuous. The camera automatically adjusts the red and blue balance ratios to achieve good color balance. Once runs for a number of iterations and then sets White Balance Auto to Off. Continuous adjusts the values continually if the

algorithm determines that the colors are imbalanced. A number of parameters that affect automatic white balance are available in the [AutoAlgorithmControl](#) category.

The white balance can also be modified by selecting a light source with [RGB Transform Light Source](#). Selecting a light source modifies both the red and blue balance ratio values as well as the active RGBtoRGB [Color Transformation](#), to achieve good color for the specified lighting condition.

## 4.4 Gamma

The [Gamma](#) feature controls the gamma correction applied to pixel intensity. The equation used is:

$$P' = P^{\text{Gamma}}$$

where  $P$  is the input pixel value and  $P'$  is the pixel value after gamma correction. Note that the value for Gamma is defined as the power applied to the pixel value, and not the gamma of the display. If a display with a gamma of 2.0 is used, the image gamma can be set to 0.5 to compensate. For sRGB output, Gamma should be set to 0.4545 (1/2.2).

If linear output data is required, disable gamma by setting [GammaEnable](#) to 0.

Gamma and the Pixel [Lookup Table](#) (LUT) can both be used at once. Gamma is applied before the Pixel LUT.

## 4.5 Sharpening

The sharpening features control how sharp the image looks.

Sharpening can be enabled (On) or disabled (Off). By default sharpening is disabled. Use [Sharpening Enable](#) to switch on or off.

When sharpening is enabled, the remaining sharpening features take effect. When it is disabled, the image is not sharpened.

Sharpening is applied only to an intensity gradient change that is above a specified threshold. This prevents sharpening from amplifying subtle intensity variances in what are otherwise smooth patches, but allows significant edges to be more pronounced.

The threshold is specified as a fraction of the total intensity range, and ranges from 0 to 0.25. A threshold higher than 25% produces little to no difference than 25%. High thresholds sharpen only areas with significant intensity changes. Low thresholds sharpen more areas.

The sharpening threshold can be controlled manually or automatically.

For manual control, set [Sharpening Auto](#) to Off. Then set a [Sharpening Threshold](#) value to indicate the minimum intensity gradient change to invoke sharpening.

For automatic control, set Sharpening Auto to On. With automatic control, the value of the Sharpening Threshold is set based on the noise level of the camera.

Adjust the sharpening amount with the [Sharpening](#) control. This value controls how much to amplify the edges above the Sharpening threshold. A value of 0 does not apply any sharpening. A negative value smooths the image. A positive value amplifies the edges of the image. You can boost by a maximum of 8x, but smoothing is limited to 1x. The default value is 2.0.

## 4.6 Summary Table

Name	Interface	Access	Visibility	Description
<a href="#">Gain Selector</a>	IEnumeration		Beginner	Selects which gain to control. The All selection is a total amplification across all channels (or taps).
<a href="#">Gain [Gain Selector]</a>	IFloat		Beginner	Controls the amplification of the video signal in dB.
<a href="#">Gain Auto</a>	IEnumeration		Beginner	Sets the automatic gain mode. Set to Off for manual control. Set to Once for a single automatic adjustment then return to Off. Set to Continuous for constant adjustment. In automatic modes, the camera adjusts the gain to maximize the dynamic range.
<a href="#">Black Level Selector</a>	IEnumeration		Beginner	Selects which black level to control. Only All can be set by the user. Analog and Digital are read-only.
<a href="#">Black Level Raw [Black Level Selector]</a>	Integer		Expert	Controls the offset of the video signal in camera specific units.
<a href="#">Black Level [Black Level Selector]</a>	IFloat		Beginner	Controls the offset of the video signal in percent.
<a href="#">Black Level Clamping Enable</a>	IBoolean	RW	Guru	Enable the black level auto clamping feature which performing dark current compensation.
<a href="#">Balance Ratio Selector</a>	IEnumeration		Expert	Selects a balance ratio to configure once a balance ratio control has been selected.
<a href="#">Balance Ratio [Balance Ratio Selector]</a>	IFloat		Expert	Controls the balance ratio of the selected color relative to green. Used for white balancing.
<a href="#">Balance White Auto</a>	IEnumeration	RW	Expert	White Balance compensates for color shifts caused by different lighting conditions. It can be automatically or manually controlled. For manual control, set to Off. For automatic control, set to Once or Continuous.
<a href="#">Gamma</a>	IFloat		Beginner	Controls the gamma correction of pixel intensity.

Name	Interface	Access	Visibility	Description
<a href="#">Gamma Enable</a>	IBoolean		Beginner	Enables/disables gamma correction.
<a href="#">Sharpening Enable</a>	IBoolean	RW	Beginner	Enables/disables the sharpening feature. Sharpening is disabled by default.
<a href="#">Sharpening Auto</a>	IBoolean	RW	Beginner	Enables/disables the auto sharpening feature. When enabled, the camera automatically determines the sharpening threshold based on the noise level of the camera.
<a href="#">Sharpening</a>	IFloat	RW	Beginner	Controls the amount to sharpen a signal. The sharpened amount is proportional to the difference between a pixel and its neighbors. A negative value smooths out the difference, while a positive value amplifies the difference. You can boost by a maximum of 8x, but smoothing is limited to 1x (in float). Default value: 2.0
<a href="#">Sharpening Threshold</a>	IFloat	RW	Guru	Controls the minimum intensity gradient change to invoke sharpening. When "Sharpening Auto" is enabled, this is determined automatically by the device. The threshold is specified as a fraction of the total intensity range, and ranges from 0 to 0.25. A threshold higher than 25% produces little to no difference than 25%. High thresholds sharpen only areas with significant intensity changes. Low thresholds sharpen more areas.

## 4.7 Analog Control Features

### 4.7.1 Gain Selector

Selects which gain to control. The All selection is a total amplification across all channels (or taps).

Property	Value
<a href="#">Name</a>	GainSelector
<a href="#">Interface</a>	IEnumeration
<a href="#">Access</a>	
<a href="#">Visibility</a>	Beginner



**Enumeration Values**

All

### 4.7.2 Gain

Controls the amplification of the video signal in dB.

Property	Value
<b>Name</b>	Gain <a href="#">[Gain Selector]</a>
<b>Interface</b>	IFloat
<b>Access</b>	
<b>Unit</b>	dB
<b>Visibility</b>	Beginner

### 4.7.3 Gain Auto

Sets the automatic gain mode. Set to Off for manual control. Set to Once for a single automatic adjustment then return to Off. Set to Continuous for constant adjustment. In automatic modes, the camera adjusts the gain to maximize the dynamic range.

Property	Value
<b>Name</b>	GainAuto
<b>Interface</b>	IEnumeration
<b>Access</b>	
<b>Visibility</b>	Beginner

**Enumeration Values**

Off

Once

Continuous

### 4.7.4 Black Level Selector

Selects which black level to control. Only All can be set by the user. Analog and Digital are read-only.

Property	Value
<b>Name</b>	BlackLevelSelector
<b>Interface</b>	IEnumeration
<b>Access</b>	
<b>Visibility</b>	Beginner

**Enumeration Values**

All
Analog
Digital

### 4.7.5 Black Level Raw

Controls the offset of the video signal in camera specific units.

Property	Value
<b>Name</b>	BlackLevelRaw <a href="#">[Black Level Selector]</a>
<b>Interface</b>	IInteger
<b>Access</b>	
<b>Unit</b>	
<b>Visibility</b>	Expert

### 4.7.6 Black Level

Controls the offset of the video signal in percent.

Property	Value
<b>Name</b>	BlackLevel <a href="#">[Black Level Selector]</a>
<b>Interface</b>	IFloat
<b>Access</b>	
<b>Unit</b>	%
<b>Visibility</b>	Beginner

### 4.7.7 Black Level Clamping Enable

Enable the black level auto clamping feature which performing dark current compensation.

Property	Value
<b>Name</b>	BlackLevelClampingEnable
<b>Interface</b>	IBoolean
<b>Access</b>	RW
<b>Visibility</b>	Guru

### 4.7.8 Balance Ratio Selector

Selects a balance ratio to configure once a balance ratio control has been selected.

Property	Value
<b>Name</b>	BalanceRatioSelector
<b>Interface</b>	IEnumeration
<b>Access</b>	
<b>Visibility</b>	Expert

#### Enumeration Values

Red
Blue

### 4.7.9 Balance Ratio

Controls the balance ratio of the selected color relative to green. Used for white balancing.

Property	Value
<b>Name</b>	BalanceRatio <a href="#">[Balance Ratio Selector]</a>
<b>Interface</b>	IFloat
<b>Access</b>	
<b>Unit</b>	
<b>Visibility</b>	Expert

### 4.7.10 Balance White Auto

White Balance compensates for color shifts caused by different lighting conditions. It can be automatically or manually controlled. For manual control, set to Off. For automatic control, set to Once or Continuous.

Property	Value
<b>Name</b>	BalanceWhiteAuto
<b>Interface</b>	IEnumeration
<b>Access</b>	RW
<b>Visibility</b>	Expert

#### Enumeration Values

Off
Once
Continuous

### 4.7.11 Gamma

Controls the gamma correction of pixel intensity.

Property	Value
<b>Name</b>	Gamma
<b>Interface</b>	IFloat
<b>Access</b>	
<b>Unit</b>	
<b>Visibility</b>	Beginner

### 4.7.12 Gamma Enable

Enables/disables gamma correction.

Property	Value
<b>Name</b>	GammaEnable
<b>Interface</b>	IBoolean

Property	Value
Access	
Visibility	Beginner

### 4.7.13 Sharpening Enable

Enables/disables the sharpening feature. Sharpening is disabled by default.

Property	Value
Name	SharpeningEnable
Interface	IBoolean
Access	RW
Visibility	Beginner

### 4.7.14 Sharpening Auto

Enables/disables the auto sharpening feature. When enabled, the camera automatically determines the sharpening threshold based on the noise level of the camera.

Property	Value
Name	SharpeningAuto
Interface	IBoolean
Access	RW
Visibility	Beginner

### 4.7.15 Sharpening

Controls the amount to sharpen a signal. The sharpened amount is proportional to the difference between a pixel and its neighbors. A negative value smooths out the difference, while a positive value amplifies the difference. You can boost by a maximum of 8x, but smoothing is limited to 1x (in float). Default value: 2.0

Property	Value
Name	Sharpening
Interface	IFloat
Access	RW

Property	Value
Unit	
Visibility	Beginner

### 4.7.16 Sharpening Threshold

Controls the minimum intensity gradient change to invoke sharpening. When "Sharpening Auto" is enabled, this is determined automatically by the device. The threshold is specified as a fraction of the total intensity range, and ranges from 0 to 0.25. A threshold higher than 25% produces little to no difference than 25%. High thresholds sharpen only areas with significant intensity changes. Low thresholds sharpen more areas.

Property	Value
Name	SharpeningThreshold
Interface	IFloat
Access	RW
Unit	
Visibility	Guru

# 5 Image Format Control

## 5.1 Binning/Decimation

Binning refers to the act of combining the signal from groups of photo-sensitive cells into a larger logical pixel. This is achieved by either adding (additive), averaging (average), or discarding (discard). Binning may be implemented in analog by the sensor or digitally by the Image Signal Processing engine (ISP).

**Note:** Binning and Decimation cannot operate simultaneously. For one to be active, the other must be inactive. Changes to binning features can only be made while the camera is not streaming.

Use the [BinningSelector](#) to choose the binning engine. This affects both horizontal and vertical binning. The choices are:

**All** - the total amount of binning. In this mode, the camera adjusts the sensor/ISP binning to achieve the best image quality with the fastest frame rate.

**Sensor** - the portion of binning implemented in analog by the sensor. Binning done by the sensor usually results in a higher frame rate. Unless otherwise specified, or unsupported, binning is done by the sensor by default.

**ISP** - the portion of binning implemented digitally by the ISP. Unless otherwise specified, binning is done by the ISP if sensor binning is unsupported or compromises image quality.

Use [BinningHorizontalMode](#) and [BinningVerticalMode](#) to choose the algorithm to perform the combination. The choices are:

**Additive** - The response from the combined cells are added, resulting in increased sensitivity (a brighter image).

**Average** - The response from the combined cells are averaged, resulting in increased signal to noise ratio. Some sensors do not support average binning.

Use [BinningHorizontal](#) and [BinningVertical](#) to set the number of cells to combine. Binning values reduce the resolution of the image by a corresponding factor. A value of 1 indicates no binning. This must be set to 1 for decimation to be active.

Use [DecimationSelector](#) to choose the decimation engine. The choices are All or Sensor. Decimation cannot be done by the ISP.

[DecimationHorizontalMode](#) and [DecimationVerticalMode](#) indicate the algorithm to perform the reduction. There is only one decimation mode supported: Discard.

Use [DecimationHorizontal](#) and [DecimationVertical](#) to set the number of cells to discard. This value reduces the resolution of the image by only retaining a single pixel within a window whose size is the specified decimation factor. A value of 1 indicates no decimation. This must be set to 1 for binning to be active.

## 5.1.1 Binning/Decimation Feature Dependency

There are many feature dependencies which can affect binning. You can disable the ISP engine which would force all binning to be sensor controlled. However, some pixel formats (such as YUV and RGB) do not allow the ISP to be disabled, as it is required for color interpolation. In addition, not all sensors support average binning.

A simple hierarchical organization of the features means that features higher up have the greatest flexibility. Choices made at the top of the hierarchy adjust features downstream. The camera always attempts to achieve the best possible image quality.

## 5.2 Pixel Format

Format of the pixel provided by the camera. Use [PixelFormat](#) feature to select from a list of supported formats. (Not all formats are supported on all cameras.) Once a format is selected, the following values are derived:

[PixelSize](#) provides the total size in bits of the image's pixel.

[PixelColorFilter](#) is the type of color filter that is applied to the image. This only applies to bayer formats. The value is None for other formats.

[PixelDynamicRangeMin](#) is the minimum value that can be returned during the digitization process. This corresponds to the darkest value of the camera. For color cameras, this returns the smallest value that each color component can take.

[PixelDynamicRangeMax](#) is the maximum value that can be returned during the digitization process. This corresponds to the brightest value of the camera. For color cameras, this returns the largest value that each color component can take.

Note: For color cameras, the bayer pixel format is updated if [Reverse X](#) and [Reverse Y](#) are changed. For example, if the original pixel format is BayerRG8 and [Reverse X](#) is switched from Disabled to Enabled, then the pixel format is updated to BayerGR8.

### 5.2.1 Single Channel 8-bit and 16-bit Formats

8-bit Formats	Mono8	8-bit monochrome packed format
	BayerGR8	8-bit bayer green red packed format
	BayerRG8	8-bit bayer red green packed format
	BayerGB8	8-bit bayer green blue packed format
	BayerBG8	8-bit bayer blue green packed format
16-bit Formats	Mono16	16-bit monochrome packed format
	BayerGR16	16-bit bayer green red packed format
	BayerRG16	16-bit bayer red green packed format
	BayerGB16	16-bit bayer green blue packed format
	BayerBG16	16-bit bayer blue green packed format



## 5.2.2 Single Channel 12-bit Formats

12-bit pixel formats have two different packing formats as defined by USB3 Vision and GigE Vision. Note: the packing format is not related to the interface of the camera. Both may be available on USB3 or GigE devices.

The USB3 Vision method is designated with a p. It is a 12-bit format with its bit-stream following the bit packing method illustrated in Figure 1. The first byte of the packed stream contains the eight least significant bits (lsb) of the first pixel. The third byte contains the eight most significant bits (msb) of the second pixel. The four lsb of the second byte contains four msb of the first pixel, and the rest of the second byte is packed with the four lsb of the second pixel.

This packing format is applied to: Mono12p, BayerGR12p, BayerRG12p, BayerGB12p and BayerBG12p.

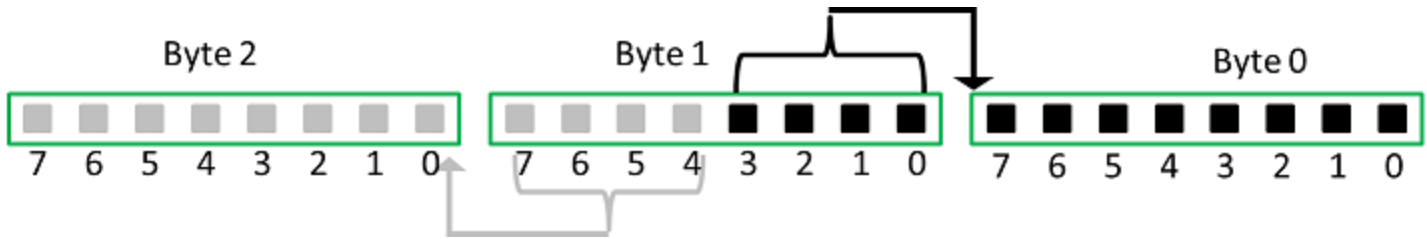

Figure 1. Packing two 12-bit pixels into three bytes.

The GigE Vision method is designated with Packed. It is a 12-bit format with its bit-stream following the bit packing method illustrated in Figure 2. The first byte of the packed stream contains the eight msb of the first pixel. The third byte contains the eight msb of the second pixel. The four lsb of the second byte contains four lsb of the first pixel, and the rest of the second byte is packed with the four lsb of the second pixel.

This packing format is applied to: Mono12Packed, BayerGR12Packed, BayerRG12Packed, BayerGB12Packed and BayerBG12Packed.

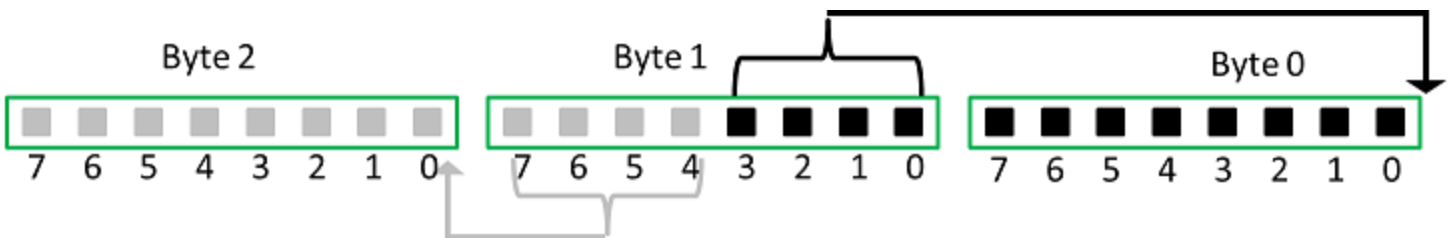

Figure 2. Packing two 12-bit pixels into three bytes.

## 5.2.3 Multi-Channel Formats

For the following pixel formats, the color channels are packed in the order indicated:

**RGB8Packed** 8-bit red-green-blue packed format

**BGR8** 8-bit blue-green-red packed format

**BGRa8** 8-bit blue-green-red-alpha packed format

For YCbCr and YUV pixel formats, the RGB to YCbCr transformation follows Equation 1 below:

$$Y' = 0.299 R' + 0.587 G' + 0.114 B'$$

$$Cb = -0.16874 R' - 0.33126 G' + 0.5000 B' + 128$$

$$Cr = 0.5000 R' - 0.41869 G' - 0.08131 B' + 128$$

### 5.2.3.1 YCbCr8 / YUV444Packed

8-bit Y-Cb-Cr 4:4:4 format (Figure 3). No sub-sampling on Y, Cb or Cr. The values of Y, Cb and Cr cover the full range from 0 to 255 if the input R, G and B values are in the range of [0, 255].

Y <sub>00</sub>	Y <sub>01</sub>	Y <sub>02</sub>	Y <sub>03</sub>	Y <sub>04</sub>	Y <sub>05</sub>	Y <sub>06</sub>	Y <sub>07</sub>	U <sub>00</sub>	U <sub>01</sub>	U <sub>02</sub>	U <sub>03</sub>	U <sub>04</sub>	U <sub>05</sub>	U <sub>06</sub>	U <sub>07</sub>	V <sub>00</sub>	V <sub>01</sub>	V <sub>02</sub>	V <sub>03</sub>	V <sub>04</sub>	V <sub>05</sub>	V <sub>06</sub>	V <sub>07</sub>
Y <sub>10</sub>	Y <sub>11</sub>	Y <sub>12</sub>	Y <sub>13</sub>	Y <sub>14</sub>	Y <sub>15</sub>	Y <sub>16</sub>	Y <sub>17</sub>	U <sub>10</sub>	U <sub>11</sub>	U <sub>12</sub>	U <sub>13</sub>	U <sub>14</sub>	U <sub>15</sub>	U <sub>16</sub>	U <sub>17</sub>	V <sub>10</sub>	V <sub>11</sub>	V <sub>12</sub>	V <sub>13</sub>	V <sub>14</sub>	V <sub>15</sub>	V <sub>16</sub>	V <sub>17</sub>
Y <sub>20</sub>	Y <sub>21</sub>	Y <sub>22</sub>	Y <sub>23</sub>	Y <sub>24</sub>	Y <sub>25</sub>	Y <sub>26</sub>	Y <sub>27</sub>	U <sub>20</sub>	U <sub>21</sub>	U <sub>22</sub>	U <sub>23</sub>	U <sub>24</sub>	U <sub>25</sub>	U <sub>26</sub>	U <sub>27</sub>	V <sub>20</sub>	V <sub>21</sub>	V <sub>22</sub>	V <sub>23</sub>	V <sub>24</sub>	V <sub>25</sub>	V <sub>26</sub>	V <sub>27</sub>
Y <sub>30</sub>	Y <sub>31</sub>	Y <sub>32</sub>	Y <sub>33</sub>	Y <sub>34</sub>	Y <sub>35</sub>	Y <sub>36</sub>	Y <sub>37</sub>	U <sub>30</sub>	U <sub>31</sub>	U <sub>32</sub>	U <sub>33</sub>	U <sub>34</sub>	U <sub>35</sub>	U <sub>36</sub>	U <sub>37</sub>	V <sub>30</sub>	V <sub>31</sub>	V <sub>32</sub>	V <sub>33</sub>	V <sub>34</sub>	V <sub>35</sub>	V <sub>36</sub>	V <sub>37</sub>
Y <sub>40</sub>	Y <sub>41</sub>	Y <sub>42</sub>	Y <sub>43</sub>	Y <sub>44</sub>	Y <sub>45</sub>	Y <sub>46</sub>	Y <sub>47</sub>	U <sub>40</sub>	U <sub>41</sub>	U <sub>42</sub>	U <sub>43</sub>	U <sub>44</sub>	U <sub>45</sub>	U <sub>46</sub>	U <sub>47</sub>	V <sub>40</sub>	V <sub>41</sub>	V <sub>42</sub>	V <sub>43</sub>	V <sub>44</sub>	V <sub>45</sub>	V <sub>46</sub>	V <sub>47</sub>

Figure 3. Y-Cb-Cr 4:4:4 format.

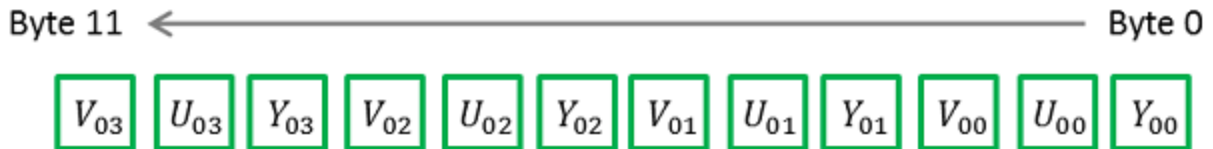

Figure 4. Packing format for YCbCr8.

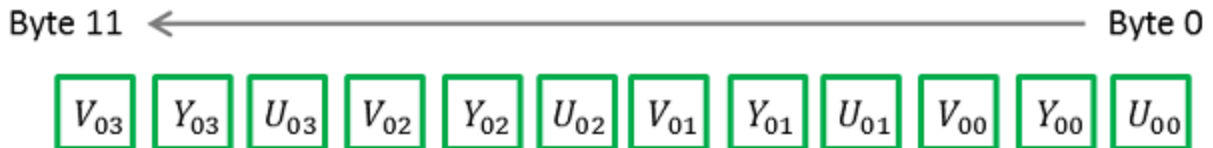

Figure 5. Packing format for YUV444Packed.

### 5.2.3.2 YCbCr422\_8 / YUV422Packed

8-bit Y-Cb-Cr 4:2:2 format (Figure 6). No sub-sampling on Y. Cb and Cr are sub-sampled by a factor of 2 in the horizontal direction, but no sub-sampling in the vertical direction. The values of Y, Cb and Cr cover the full range from 0 to 255 if the input R, G and B values are in the range of [0, 255].

Y <sub>00</sub>	Y <sub>01</sub>	Y <sub>02</sub>	Y <sub>03</sub>	Y <sub>04</sub>	Y <sub>05</sub>	Y <sub>06</sub>	Y <sub>07</sub>	U <sub>00</sub>	U <sub>01</sub>	U <sub>02</sub>	U <sub>03</sub>	U <sub>04</sub>	U <sub>05</sub>	U <sub>06</sub>	U <sub>07</sub>	V <sub>00</sub>	V <sub>01</sub>	V <sub>02</sub>	V <sub>03</sub>	V <sub>04</sub>	V <sub>05</sub>	V <sub>06</sub>	V <sub>07</sub>
Y <sub>10</sub>	Y <sub>11</sub>	Y <sub>12</sub>	Y <sub>13</sub>	Y <sub>14</sub>	Y <sub>15</sub>	Y <sub>16</sub>	Y <sub>17</sub>	U <sub>10</sub>	U <sub>11</sub>	U <sub>12</sub>	U <sub>13</sub>	U <sub>14</sub>	U <sub>15</sub>	U <sub>16</sub>	U <sub>17</sub>	V <sub>10</sub>	V <sub>11</sub>	V <sub>12</sub>	V <sub>13</sub>	V <sub>14</sub>	V <sub>15</sub>	V <sub>16</sub>	V <sub>17</sub>
Y <sub>20</sub>	Y <sub>21</sub>	Y <sub>22</sub>	Y <sub>23</sub>	Y <sub>24</sub>	Y <sub>25</sub>	Y <sub>26</sub>	Y <sub>27</sub>	U <sub>20</sub>	U <sub>21</sub>	U <sub>22</sub>	U <sub>23</sub>	U <sub>24</sub>	U <sub>25</sub>	U <sub>26</sub>	U <sub>27</sub>	V <sub>20</sub>	V <sub>21</sub>	V <sub>22</sub>	V <sub>23</sub>	V <sub>24</sub>	V <sub>25</sub>	V <sub>26</sub>	V <sub>27</sub>
Y <sub>30</sub>	Y <sub>31</sub>	Y <sub>32</sub>	Y <sub>33</sub>	Y <sub>34</sub>	Y <sub>35</sub>	Y <sub>36</sub>	Y <sub>37</sub>	U <sub>30</sub>	U <sub>31</sub>	U <sub>32</sub>	U <sub>33</sub>	U <sub>34</sub>	U <sub>35</sub>	U <sub>36</sub>	U <sub>37</sub>	V <sub>30</sub>	V <sub>31</sub>	V <sub>32</sub>	V <sub>33</sub>	V <sub>34</sub>	V <sub>35</sub>	V <sub>36</sub>	V <sub>37</sub>
Y <sub>40</sub>	Y <sub>41</sub>	Y <sub>42</sub>	Y <sub>43</sub>	Y <sub>44</sub>	Y <sub>45</sub>	Y <sub>46</sub>	Y <sub>47</sub>	U <sub>40</sub>	U <sub>41</sub>	U <sub>42</sub>	U <sub>43</sub>	U <sub>44</sub>	U <sub>45</sub>	U <sub>46</sub>	U <sub>47</sub>	V <sub>40</sub>	V <sub>41</sub>	V <sub>42</sub>	V <sub>43</sub>	V <sub>44</sub>	V <sub>45</sub>	V <sub>46</sub>	V <sub>47</sub>

Figure 6. Y-Cb-Cr 4:2:2 format.

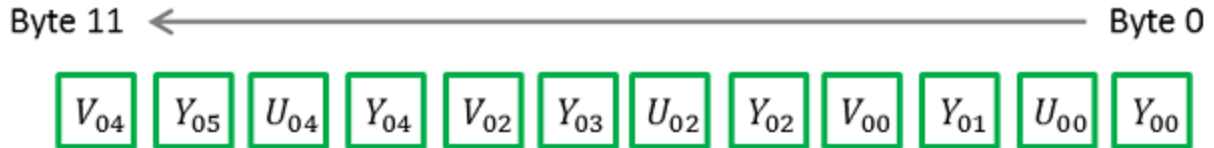

Figure 7. Packing format for YCbCr422\_8.

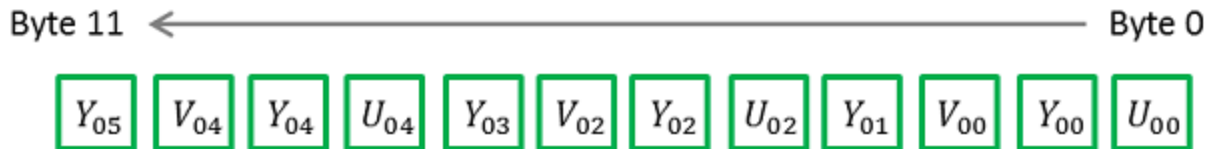

Figure 8. Packing format for YUV422Packed.

### 5.2.3.3 YCbCr411\_8 / YUV411Packed

8-bit Y-Cb-Cr 4:1:1 format (Figure 9). No sub-sampling on Y. Cb and Cr are sub-sampled by a factor of 4 in the horizontal direction, but no sub-sampling in the vertical direction. The values of Y, Cb and Cr cover the full range from 0 to 255 if the input R, G and B values are in the range of [0, 255].

Y <sub>00</sub>	Y <sub>01</sub>	Y <sub>02</sub>	Y <sub>03</sub>	Y <sub>04</sub>	Y <sub>05</sub>	Y <sub>06</sub>	Y <sub>07</sub>	U <sub>00</sub>	U <sub>01</sub>	U <sub>02</sub>	U <sub>03</sub>	U <sub>04</sub>	U <sub>05</sub>	U <sub>06</sub>	U <sub>07</sub>	V <sub>00</sub>	V <sub>01</sub>	V <sub>02</sub>	V <sub>03</sub>	V <sub>04</sub>	V <sub>05</sub>	V <sub>06</sub>	V <sub>07</sub>
Y <sub>10</sub>	Y <sub>11</sub>	Y <sub>12</sub>	Y <sub>13</sub>	Y <sub>14</sub>	Y <sub>15</sub>	Y <sub>16</sub>	Y <sub>17</sub>	U <sub>10</sub>	U <sub>11</sub>	U <sub>12</sub>	U <sub>13</sub>	U <sub>14</sub>	U <sub>15</sub>	U <sub>16</sub>	U <sub>17</sub>	V <sub>10</sub>	V <sub>11</sub>	V <sub>12</sub>	V <sub>13</sub>	V <sub>14</sub>	V <sub>15</sub>	V <sub>16</sub>	V <sub>17</sub>
Y <sub>20</sub>	Y <sub>21</sub>	Y <sub>22</sub>	Y <sub>23</sub>	Y <sub>24</sub>	Y <sub>25</sub>	Y <sub>26</sub>	Y <sub>27</sub>	U <sub>20</sub>	U <sub>21</sub>	U <sub>22</sub>	U <sub>23</sub>	U <sub>24</sub>	U <sub>25</sub>	U <sub>26</sub>	U <sub>27</sub>	V <sub>20</sub>	V <sub>21</sub>	V <sub>22</sub>	V <sub>23</sub>	V <sub>24</sub>	V <sub>25</sub>	V <sub>26</sub>	V <sub>27</sub>
Y <sub>30</sub>	Y <sub>31</sub>	Y <sub>32</sub>	Y <sub>33</sub>	Y <sub>34</sub>	Y <sub>35</sub>	Y <sub>36</sub>	Y <sub>37</sub>	U <sub>30</sub>	U <sub>31</sub>	U <sub>32</sub>	U <sub>33</sub>	U <sub>34</sub>	U <sub>35</sub>	U <sub>36</sub>	U <sub>37</sub>	V <sub>30</sub>	V <sub>31</sub>	V <sub>32</sub>	V <sub>33</sub>	V <sub>34</sub>	V <sub>35</sub>	V <sub>36</sub>	V <sub>37</sub>
Y <sub>40</sub>	Y <sub>41</sub>	Y <sub>42</sub>	Y <sub>43</sub>	Y <sub>44</sub>	Y <sub>45</sub>	Y <sub>46</sub>	Y <sub>47</sub>	U <sub>40</sub>	U <sub>41</sub>	U <sub>42</sub>	U <sub>43</sub>	U <sub>44</sub>	U <sub>45</sub>	U <sub>46</sub>	U <sub>47</sub>	V <sub>40</sub>	V <sub>41</sub>	V <sub>42</sub>	V <sub>43</sub>	V <sub>44</sub>	V <sub>45</sub>	V <sub>46</sub>	V <sub>47</sub>

Figure 9. Y-Cb-Cr 4:1:1 format.

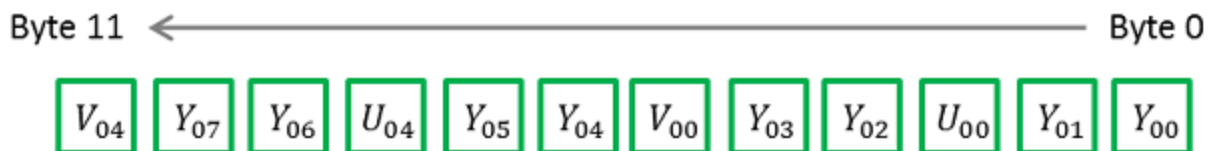

Figure 10. Packing format for YCbCr411\_8.

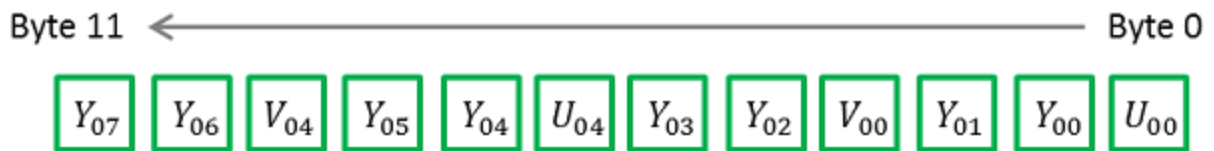

Figure 12. Packing format for YUV411Packed.

## 5.3 ADC Bit Depth

All camera sensors incorporate an analog to digital converter (ADC) to digitize the images.

The camera's ADC is configured to a fixed bit output. This is not the same as pixel size. If the pixel format selected has fewer bits per pixel than the ADC output, the least significant bits are dropped. If the pixel format selected has greater bits per pixel than the ADC output, the least significant bits are padded and can be discarded by the user. Image data is left-aligned across a 2-byte format.

For example, for a 12-bit output, the least significant 4 bits are padded in order to fill 2 bytes (0xFF0).

A 10-bit conversion produces 1,024 possible values between 0 and 65,472.

A 12-bit conversion produces 4,096 possible values between 0 and 65,520.

A 14-bit conversion produces 16,384 possible values between 0 and 65,532.

Some image sensors support multiple ADC bit depths. A higher ADC bit depth results in better image quality but slower maximum frame rate. Stop acquisition then use the [ADC Bit Depth](#) control to make a selection.

## 5.4 Test Pattern

The camera is capable of outputting continuous static images for testing and development purposes.

Use the [TestPatternGeneratorSelector](#) feature to choose which test pattern to control.

Sensor produces a test pattern that varies based on the image sensor.

Pipeline Start inserts a test pattern at the start of the camera's image processing pipeline.

Set the [TestPattern](#) feature to Off to disable the selected test pattern generator.

When Sensor is selected, create a test pattern by setting the [TestPattern](#) feature to Sensor Test Pattern.

When Pipeline Start is selected, create a test pattern by setting the [TestPattern](#) feature to Increment. The Increment test pattern increases the pixel value by one 8-bit greyscale value at each pixel location, wrapping around to zero after it reaches 255.

Both test pattern generators can be enabled at the same time, however, the Pipeline Start test pattern overwrites the Sensor test pattern.

Most image processing features (such as [Gamma](#), [Balance Ratio](#), and others) are still available when the test pattern is on and can alter the test pattern image. Some features for controlling the sensor do not affect the test pattern image, such as [Exposure Time](#), [Gain](#), and analog [Black Level](#). It is recommended to turn [Exposure Auto](#) and [Gain Auto](#) Off when using a test pattern, as those features do not function properly when the test pattern is on.

Note that the test pattern generators must be set to Off to get the actual image data from the sensor.

## 5.5 Region Of Interest

An image region of interest (ROI) lets you specify a portion of the image so that after each image is acquired only the pixel information from the specified portion is processed.

Use the following features to specify the location and size of the ROI. All values are in pixels.

[OffsetX](#) - Horizontal offset from the origin to the ROI.

[Width](#) - Width of the image provided by the device. This reflects the current ROI. The maximum value of this feature takes into account horizontal binning, decimation, or any other function

changing the maximum horizontal dimensions of the image and is typically equal to [WidthMax](#) minus [OffsetX](#).

[OffsetY](#) - Vertical offset from the origin to the ROI.

[Height](#) - Height of the image provided by the device. This reflects the current ROI. The maximum value of this feature takes into account vertical binning, decimation, or any other function changing the maximum vertical dimensions of the image and is typically equal to [HeightMax](#) minus [OffsetY](#).

## 5.6 Reverse X

When Reverse X is enabled, it horizontally flips the image sent by the camera. The region of interest is applied after flipping.

For color cameras, the bayer pixel format may be changed after flipping. For example, BayerRG16 is changed to BayerGR16.

## 5.7 Reverse Y

When Reverse Y is enabled, it vertically flips the image sent by the camera. The region of interest is applied after flipping.

For color cameras, the bayer pixel format may be changed after flipping. For example, BayerRG16 is changed to BayerGB16.

## 5.8 Summary Table

Name	Interface	Access	Visibility	Description
<a href="#">Sensor Width</a>	Integer	RO	Expert	Effective width of the sensor in pixels.
<a href="#">Sensor Height</a>	Integer	RO	Expert	Effective height of the sensor in pixels.
<a href="#">Width Max</a>	Integer		Expert	Maximum width of the image (in pixels). The dimension is calculated after horizontal binning. WidthMax does not take into account the current Region of interest (Width or OffsetX).
<a href="#">Height Max</a>	Integer		Expert	Maximum height of the image (in pixels). This dimension is calculated after vertical binning. HeightMax does not take into account the current Region of interest (Height or OffsetY).
<a href="#">Width</a>	Integer		Beginner	Width of the image provided by the device (in pixels).
<a href="#">Height</a>	Integer		Beginner	Height of the image provided by the device (in pixels).

Name	Interface	Access	Visibility	Description
<a href="#">Offset X</a>	Integer		Beginner	Horizontal offset from the origin to the ROI (in pixels).
<a href="#">Offset Y</a>	Integer		Beginner	Vertical offset from the origin to the ROI (in pixels).
<a href="#">Pixel Format</a>	Enumeration		Beginner	Format of the pixel provided by the camera.
<a href="#">Pixel Size</a>	Enumeration	RO	Expert	Total size in bits of a pixel of the image.
<a href="#">Pixel Color Filter</a>	Enumeration	RO	Expert	Type of color filter that is applied to the image. Only applies to Bayer pixel formats. All others have no color filter.
<a href="#">Pixel Dynamic Range Min</a>	Integer	RO	Expert	Minimum value that can be returned during the digitization process. This corresponds to the darkest value of the camera. For color cameras, this returns the smallest value that each color component can take.
<a href="#">Pixel Dynamic Range Max</a>	Integer	RO	Expert	Maximum value that can be returned during the digitization process. This corresponds to the brightest value of the camera. For color cameras, this returns the biggest value that each color component can take.
<a href="#">ISP Enable</a>	Boolean	RW	Expert	Controls whether the image processing core is used for optional pixel format mode (i.e. mono).
<a href="#">Binning Selector</a>	Enumeration		Beginner	Selects which binning engine is controlled by the BinningHorizontal and BinningVertical features.
<a href="#">Binning Horizontal Mode [Binning Selector]</a>	Enumeration		Expert	
<a href="#">Binning Vertical Mode [Binning Selector]</a>	Enumeration		Expert	
<a href="#">Binning Horizontal [Binning Selector]</a>	Integer		Beginner	Number of horizontal photo-sensitive cells to combine together. This reduces the horizontal resolution (width) of the image. A value of 1 indicates that no horizontal binning is performed by the camera. This value must be 1 for decimation to be active.

Name	Interface	Access	Visibility	Description
<a href="#">Binning Vertical [Binning Selector]</a>	IInteger		Beginner	Number of vertical photo-sensitive cells to combine together. This reduces the vertical resolution (height) of the image. A value of 1 indicates that no vertical binning is performed by the camera. This value must be 1 for decimation to be active.
<a href="#">Decimation Selector</a>	IEnumeration		Beginner	Selects which decimation layer is controlled by the DecimationHorizontal and DecimationVertical features.
<a href="#">Decimation Horizontal Mode [Decimation Selector]</a>	IEnumeration		Expert	The mode used to reduce the horizontal resolution when DecimationHorizontal is used. The current implementation only supports a single decimation mode: Discard. Average should be achieved via Binning.
<a href="#">Decimation Vertical Mode [Decimation Selector]</a>	IEnumeration		Expert	The mode used to reduce the vertical resolution when DecimationVertical is used. The current implementation only supports a single decimation mode: Discard. Average should be achieved via Binning.
<a href="#">Decimation Horizontal [Decimation Selector]</a>	IInteger		Beginner	Horizontal decimation of the image. This reduces the horizontal resolution (width) of the image by only retaining a single pixel within a window whose size is the decimation factor specified here. A value of 1 indicates that no horizontal decimation is performed by the camera. This value must be 1 for binning to be active.
<a href="#">Decimation Vertical [Decimation Selector]</a>	IInteger		Beginner	Vertical decimation of the image. This reduces the vertical resolution (height) of the image by only retaining a single pixel within a window whose size is the decimation factor specified here. A value of 1 indicates that no vertical decimation is performed by the camera. This value must be 1 for binning to be active.
<a href="#">Reverse X</a>	IBoolean	RW	Expert	Horizontally flips the image sent by the device. The region of interest is applied after flipping. For color cameras the bayer pixel format is affected. For example, BayerRG16 changes to BayerGR16.
<a href="#">Reverse Y</a>	IBoolean	RW	Expert	Vertically flips the image sent by the device. The region of interest is applied after flipping. For color cameras the bayer pixel format is affected. For example, BayerRG16 changes to BayerGB16.
<a href="#">Test Pattern</a>	IEnumeration			Selects which test pattern generator is controlled

Name	Interface	Access	Visibility	Description
<a href="#">Generator Selector</a>				by the TestPattern feature.
<a href="#">Test Pattern [Test Pattern Generator Selector]</a>	IEnumeration			Selects the type of test pattern that is generated by the device as image source.
<a href="#">ADC Bit Depth</a>	IEnumeration		Beginner	Selects which ADC bit depth to use. A higher ADC bit depth results in better image quality but slower maximum frame rate.

## 5.9 Image Format Control Features

### 5.9.1 Sensor Width

Effective width of the sensor in pixels.

Property	Value
<b>Name</b>	SensorWidth
<b>Interface</b>	IInteger
<b>Access</b>	RO
<b>Unit</b>	
<b>Visibility</b>	Expert
<b>Value</b>	4096

### 5.9.2 Sensor Height

Effective height of the sensor in pixels.

Property	Value
<b>Name</b>	SensorHeight
<b>Interface</b>	IInteger
<b>Access</b>	RO
<b>Unit</b>	



Property	Value
Visibility	Expert
Value	3008

### 5.9.3 Width Max

Maximum width of the image (in pixels). The dimension is calculated after horizontal binning. WidthMax does not take into account the current Region of interest (Width or OffsetX).

Property	Value
Name	WidthMax
Interface	Integer
Access	
Unit	
Visibility	Expert

### 5.9.4 Height Max

Maximum height of the image (in pixels). This dimension is calculated after vertical binning. HeightMax does not take into account the current Region of interest (Height or OffsetY).

Property	Value
Name	HeightMax
Interface	Integer
Access	
Unit	
Visibility	Expert

### 5.9.5 Width

Width of the image provided by the device (in pixels).

Property	Value
Name	Width
Interface	Integer
Access	

Property	Value
Unit	
Visibility	Beginner

### 5.9.6 Height

Height of the image provided by the device (in pixels).

Property	Value
Name	Height
Interface	Integer
Access	
Unit	
Visibility	Beginner

### 5.9.7 Offset X

Horizontal offset from the origin to the ROI (in pixels).

Property	Value
Name	OffsetX
Interface	Integer
Access	
Unit	
Visibility	Beginner

### 5.9.8 Offset Y

Vertical offset from the origin to the ROI (in pixels).

Property	Value
Name	OffsetY
Interface	Integer
Access	

Property	Value
<b>Unit</b>	
<b>Visibility</b>	Beginner

### 5.9.9 Pixel Format

Format of the pixel provided by the camera.

Property	Value
<b>Name</b>	PixelFormat
<b>Interface</b>	IEnumeration
<b>Access</b>	
<b>Visibility</b>	Beginner

#### Enumeration Values

Mono8
Mono16
RGB8Packed
BayerGR8
BayerRG8
BayerGB8
BayerBG8
BayerGR16
BayerRG16
BayerGB16
BayerBG16
Mono12Packed
BayerGR12Packed
BayerRG12Packed
BayerGB12Packed

**Enumeration Values**

BayerBG12Packed
YUV411Packed
YUV422Packed
YUV444Packed
Mono12p
BayerGR12p
BayerRG12p
BayerGB12p
BayerBG12p
YCbCr8
YCbCr422_8
YCbCr411_8
BGR8
BGRa8

### 5.9.10 Pixel Size

Total size in bits of a pixel of the image.

Property	Value
<b>Name</b>	PixelFormat
<b>Interface</b>	IEnumeration
<b>Access</b>	RO
<b>Visibility</b>	Expert

**Enumeration Values**

Bpp1
Bpp2
Bpp4

**Enumeration Values**

Bpp8
Bpp10
Bpp12
Bpp14
Bpp16
Bpp20
Bpp24
Bpp30
Bpp32
Bpp36
Bpp48
Bpp64
Bpp96

### 5.9.11 Pixel Color Filter

Type of color filter that is applied to the image. Only applies to Bayer pixel formats. All others have no color filter.

Property	Value
<b>Name</b>	PixelColorFilter
<b>Interface</b>	IEnumeration
<b>Access</b>	RO
<b>Visibility</b>	Expert

**Enumeration Values**

None
BayerRG
BayerGB
BayerGR

### Enumeration Values

BayerBG

#### 5.9.12 Pixel Dynamic Range Min

Minimum value that can be returned during the digitization process. This corresponds to the darkest value of the camera. For color cameras, this returns the smallest value that each color component can take.

Property	Value
<b>Name</b>	PixelDynamicRangeMin
<b>Interface</b>	Integer
<b>Access</b>	RO
<b>Unit</b>	
<b>Visibility</b>	Expert
<b>Value</b>	0

#### 5.9.13 Pixel Dynamic Range Max

Maximum value that can be returned during the digitization process. This corresponds to the brightest value of the camera. For color cameras, this returns the biggest value that each color component can take.

Property	Value
<b>Name</b>	PixelDynamicRangeMax
<b>Interface</b>	Integer
<b>Access</b>	RO
<b>Unit</b>	
<b>Visibility</b>	Expert

#### 5.9.14 ISP Enable

Controls whether the image processing core is used for optional pixel format mode (i.e. mono).

Property	Value
<b>Name</b>	IspEnable

Property	Value
Interface	IBoolean
Access	RW
Visibility	Expert

### 5.9.15 Binning Selector

Selects which binning engine is controlled by the BinningHorizontal and BinningVertical features.

Property	Value
Name	BinningSelector
Interface	IEnumeration
Access	
Visibility	Beginner

#### Enumeration Values

All
Sensor
ISP

### 5.9.16 Binning Horizontal Mode

Property	Value
Name	BinningHorizontalMode <a href="#">[Binning Selector]</a>
Interface	IEnumeration
Access	
Visibility	Expert

#### Enumeration Values

Sum
Average

### 5.9.17 Binning Vertical Mode

Property	Value
<b>Name</b>	BinningVerticalMode <a href="#">[Binning Selector]</a>
<b>Interface</b>	IEnumeration
<b>Access</b>	
<b>Visibility</b>	Expert

#### Enumeration Values

Sum
Average

### 5.9.18 Binning Horizontal

Number of horizontal photo-sensitive cells to combine together. This reduces the horizontal resolution (width) of the image. A value of 1 indicates that no horizontal binning is performed by the camera. This value must be 1 for decimation to be active.

Property	Value
<b>Name</b>	BinningHorizontal <a href="#">[Binning Selector]</a>
<b>Interface</b>	IInteger
<b>Access</b>	
<b>Unit</b>	
<b>Visibility</b>	Beginner

### 5.9.19 Binning Vertical

Number of vertical photo-sensitive cells to combine together. This reduces the vertical resolution (height) of the image. A value of 1 indicates that no vertical binning is performed by the camera. This value must be 1 for decimation to be active.

Property	Value
<b>Name</b>	BinningVertical <a href="#">[Binning Selector]</a>
<b>Interface</b>	IInteger
<b>Access</b>	



Property	Value
Unit	
Visibility	Beginner

### 5.9.20 Decimation Selector

Selects which decimation layer is controlled by the DecimationHorizontal and DecimationVertical features.

Property	Value
Name	DecimationSelector
Interface	IEnumeration
Access	
Visibility	Beginner

#### Enumeration Values

All
Sensor

### 5.9.21 Decimation Horizontal Mode

The mode used to reduce the horizontal resolution when DecimationHorizontal is used. The current implementation only supports a single decimation mode: Discard. Average should be achieved via Binning.

Property	Value
Name	DecimationHorizontalMode <a href="#">[Decimation Selector]</a>
Interface	IEnumeration
Access	
Visibility	Expert

#### Enumeration Values

Discard
---------

## 5.9.22 Decimation Vertical Mode

The mode used to reduce the vertical resolution when DecimationVertical is used. The current implementation only supports a single decimation mode: Discard. Average should be achieved via Binning.

Property	Value
Name	DecimationVerticalMode <a href="#">[Decimation Selector]</a>
Interface	IEnumeration
Access	
Visibility	Expert

### Enumeration Values

Discard

## 5.9.23 Decimation Horizontal

Horizontal decimation of the image. This reduces the horizontal resolution (width) of the image by only retaining a single pixel within a window whose size is the decimation factor specified here. A value of 1 indicates that no horizontal decimation is performed by the camera. This value must be 1 for binning to be active.

Property	Value
Name	DecimationHorizontal <a href="#">[Decimation Selector]</a>
Interface	IInteger
Access	
Unit	
Visibility	Beginner

## 5.9.24 Decimation Vertical

Vertical decimation of the image. This reduces the vertical resolution (height) of the image by only retaining a single pixel within a window whose size is the decimation factor specified here. A value of 1 indicates that no vertical decimation is performed by the camera. This value must be 1 for binning to be active.

Property	Value
Name	DecimationVertical <a href="#">[Decimation Selector]</a>

Property	Value
Interface	Integer
Access	
Unit	
Visibility	Beginner

### 5.9.25 Reverse X

Horizontally flips the image sent by the device. The region of interest is applied after flipping. For color cameras the bayer pixel format is affected. For example, BayerRG16 changes to BayerGR16.

Property	Value
Name	ReverseX
Interface	IBoolean
Access	RW
Visibility	Expert

### 5.9.26 Reverse Y

Vertically flips the image sent by the device. The region of interest is applied after flipping. For color cameras the bayer pixel format is affected. For example, BayerRG16 changes to BayerGB16.

Property	Value
Name	ReverseY
Interface	IBoolean
Access	RW
Visibility	Expert

### 5.9.27 Test Pattern Generator Selector

Selects which test pattern generator is controlled by the TestPattern feature.

Property	Value
Name	TestPatternGeneratorSelector
Interface	IEnumeration
Access	

Property	Value
Visibility	

**Enumeration Values**

Sensor
PipelineStart

### 5.9.28 Test Pattern

Selects the type of test pattern that is generated by the device as image source.

Property	Value
Name	TestPattern <a href="#">[Test Pattern Generator Selector]</a>
Interface	IEnumeration
Access	
Visibility	

**Enumeration Values**

Off
Increment
SensorTestPattern

### 5.9.29 ADC Bit Depth

Selects which ADC bit depth to use. A higher ADC bit depth results in better image quality but slower maximum frame rate.

Property	Value
Name	AdcBitDepth
Interface	IEnumeration
Access	
Visibility	Beginner

### Enumeration Values

Bit8

Bit10

Bit12

## 6 Device Control

Device Control provides you with device information and allows you to control some device parameters.

### 6.1 General Information

Use [Device User ID](#) to enter a unique device name. This information is retained over power cycles.

Use [Device Indicator Mode](#) to control the status LED. The LED can be active, inactive, or in error mode.

### 6.2 Bandwidth

Information about the bandwidth usage and link speed is provided.

Use [Device Link Throughput Limit](#) to specify what bandwidth is used for the streaming of data. This affects the maximum frame rate. This must be less than the Device Max Throughput.

### 6.3 Timestamp

Use [Timestamp Latch](#) to capture the current timestamp of the device.

### 6.4 Power Supply

Use the [Device Power Supply Selector](#) to choose a power supply, either External or Sensor (Internal). External power is either through the device interface or through GPIO.

### 6.5 Device Reset

Use [Device Reset](#) to soft reboot the camera. Use [Factory Reset](#) to clear any user tables loaded and perform a soft reboot of the camera.

### 6.6 Summary Table

Name	Interface	Access	Visibility	Description
<a href="#">Device Scan Type</a>	IEnumeration	RO	Expert	Scan type of the sensor of the device.
<a href="#">Device Vendor Name</a>	IStringReg		Beginner	Name of the manufacturer of the device.
<a href="#">Device Model Name</a>	IStringReg		Beginner	Model of the device.

Name	Interface	Access	Visibility	Description
<a href="#">Sensor Description</a>	IStringReg		Guru	Returns Sensor Description
<a href="#">Device Manufacturer Info</a>	IStringReg		Beginner	Manufacturer information about the device.
<a href="#">Firmware Version</a>	IStringReg		Beginner	Version of the firmware on the device.
<a href="#">Serial Number</a>	IStringReg		Expert	Device's serial number. This string is a unique identifier of the device.
<a href="#">User ID</a>	IStringReg		Beginner	User-programmable device identifier.
<a href="#">Device TL Type</a>	IEnumeration	RO	Beginner	Transport Layer type of the device.
<a href="#">TL Version Major</a>	Integer	RO	Beginner	Major version of the Transport Layer of the device.
<a href="#">TL Version Minor</a>	Integer	RO	Beginner	Minor version of the Transport Layer of the device.
<a href="#">Device Max Throughput</a>	Integer	RO	Expert	Maximum bandwidth of the data that can be streamed out of the device. This can be used to estimate if the physical connection(s) can sustain transfer of free-running images from the camera at its maximum speed.
<a href="#">Link Speed</a>	Integer	RO	Expert	Indicates the speed of transmission negotiated on the specified Link. (Bps)
<a href="#">Device Link Throughput Limit</a>	Integer	RW	Expert	Limits the maximum bandwidth of the data that will be streamed out by the device on the selected Link. If necessary, delays will be uniformly inserted between transport layer packets in order to control the peak bandwidth.
<a href="#">Device Link Bandwidth Reserve</a>	Float	RW	Expert	Percentage of streamed data bandwidth reserved for packet resend.
<a href="#">Device Link Current Throughput</a>	Integer	RO	Expert	Current bandwidth of streamed data.
<a href="#">Stream Channel Count</a>	Integer	RO	Expert	Indicates the number of streaming channels supported by the device.
<a href="#">Event Channel Count</a>	Integer	RO	Expert	Indicates the number of event channels supported by the device.

Name	Interface	Access	Visibility	Description
<a href="#">Character Set</a>	IEnumeration	RO	Guru	Character set used by the strings of the device's bootstrap registers.
<a href="#">Device Reset</a>	ICommand	WO	Guru	This is a command that immediately resets and reboots the device.
<a href="#">Device Indicator Mode</a>	IEnumeration		Expert	Controls the LED behaviour: Inactive (off), Active (current status), or Error Status (off unless an error occurs).
<a href="#">Registers Endianness</a>	IEnumeration	RO	Guru	Endianness of the registers of the device.
<a href="#">Device Temperature Selector</a>	IEnumeration		Expert	Selects the location within the device, where the temperature will be measured.
<a href="#">Device Temperature [Device Temperature Selector]</a>	IFloat	RO	Expert	Device temperature in degrees Celsius (C).
<a href="#">Timestamp Reset</a>	ICommand	WO	Expert	Resets the current value of the device timestamp counter.
<a href="#">Timestamp Latch</a>	ICommand	WO	Expert	Latches the current timestamp counter into TimestampLatchValue.
<a href="#">Timestamp Latch Value</a>	Integer	RO	Expert	Returns the latched value of the timestamp counter.
<a href="#">Device Power Supply Selector</a>	IEnumeration		Expert	Selects the power supply source to control or read.
<a href="#">Power Supply Voltage [Device Power Supply Selector]</a>	IFloat	RO	Expert	Indicates the current voltage of the selected power supply (V).
<a href="#">Power Supply Current [Device Power Supply Selector]</a>	IFloat	RO	Expert	Indicates the output current of the selected power supply (A).
<a href="#">Device Uptime</a>	Integer	RO	Expert	Total time since the device was powered up in seconds.
<a href="#">Link Uptime</a>	Integer	RO	Expert	Time since the last phy negotiation (enumeration).



Name	Interface	Access	Visibility	Description
<a href="#">Enumeration Count</a>	IInteger	RO	Expert	Number of enumerations since uptime.
<a href="#">Factory Reset</a>	ICommand	WO	Guru	Returns all user tables to factory default
<a href="#">Max Device Reset Time</a>	IInteger	RO	Expert	Time to wait until device reset complete (ms).

## 6.7 Device Control Features

### 6.7.1 Device Scan Type

Scan type of the sensor of the device.

Property	Value
<b>Name</b>	DeviceScanType
<b>Interface</b>	IEnumeration
<b>Access</b>	RO
<b>Visibility</b>	Expert

#### Enumeration Values

Areascan

### 6.7.2 Device Vendor Name

Name of the manufacturer of the device.

Property	Value
<b>Name</b>	DeviceVendorName
<b>Interface</b>	IStringReg
<b>Access</b>	
<b>Visibility</b>	Beginner

### 6.7.3 Device Model Name

Model of the device.

Property	Value
<b>Name</b>	DeviceModelName
<b>Interface</b>	IStringReg
<b>Access</b>	
<b>Visibility</b>	Beginner

## 6.7.4 Sensor Description

Returns Sensor Description

Property	Value
<b>Name</b>	SensorDescription
<b>Interface</b>	IStringReg
<b>Access</b>	
<b>Visibility</b>	Guru

## 6.7.5 Device Manufacturer Info

Manufacturer information about the device.

Property	Value
<b>Name</b>	DeviceManufacturerInfo
<b>Interface</b>	IStringReg
<b>Access</b>	
<b>Visibility</b>	Beginner

## 6.7.6 Firmware Version

Version of the firmware on the device.

Property	Value
<b>Name</b>	DeviceFirmwareVersion
<b>Interface</b>	IStringReg
<b>Access</b>	
<b>Visibility</b>	Beginner

## 6.7.7 Serial Number

Device's serial number. This string is a unique identifier of the device.

Property	Value
<b>Name</b>	DeviceSerialNumber
<b>Interface</b>	IStringReg
<b>Access</b>	
<b>Visibility</b>	Expert

## 6.7.8 User ID

User-programmable device identifier.

Property	Value
<b>Name</b>	DeviceUserID
<b>Interface</b>	IStringReg
<b>Access</b>	
<b>Visibility</b>	Beginner

## 6.7.9 Device TL Type

Transport Layer type of the device.

Property	Value
<b>Name</b>	DeviceTLType
<b>Interface</b>	IEnumeration
<b>Access</b>	RO
<b>Visibility</b>	Beginner

### Enumeration Values

GigEVision
CameraLink
CameraLinkHS

**Enumeration Values**

CoaXPress
USB3Vision
Custom

### 6.7.10 TL Version Major

Major version of the Transport Layer of the device.

Property	Value
<b>Name</b>	DeviceTLVersionMajor
<b>Interface</b>	Integer
<b>Access</b>	RO
<b>Unit</b>	
<b>Visibility</b>	Beginner

### 6.7.11 TL Version Minor

Minor version of the Transport Layer of the device.

Property	Value
<b>Name</b>	DeviceTLVersionMinor
<b>Interface</b>	Integer
<b>Access</b>	RO
<b>Unit</b>	
<b>Visibility</b>	Beginner

### 6.7.12 Device Max Throughput

Maximum bandwidth of the data that can be streamed out of the device. This can be used to estimate if the physical connection(s) can sustain transfer of free-running images from the camera at its maximum speed.

Property	Value
<b>Name</b>	DeviceMaxThroughput
<b>Interface</b>	Integer

Property	Value
Access	RO
Unit	Bps
Visibility	Expert

### 6.7.13 Link Speed

Indicates the speed of transmission negotiated on the specified Link. (Bps)

Property	Value
Name	DeviceLinkSpeed
Interface	Integer
Access	RO
Unit	
Visibility	Expert

### 6.7.14 Device Link Throughput Limit

Limits the maximum bandwidth of the data that will be streamed out by the device on the selected Link. If necessary, delays will be uniformly inserted between transport layer packets in order to control the peak bandwidth.

Property	Value
Name	DeviceLinkThroughputLimit
Interface	Integer
Access	RW
Unit	Bps
Visibility	Expert

### 6.7.15 Device Link Bandwidth Reserve

Percentage of streamed data bandwidth reserved for packet resend.

Property	Value
Name	DeviceLinkBandwidthReserve
Interface	Float

Property	Value
Access	RW
Unit	%
Visibility	Expert

### 6.7.16 Device Link Current Throughput

Current bandwidth of streamed data.

Property	Value
Name	DeviceLinkCurrentThroughput
Interface	Integer
Access	RO
Unit	Bps
Visibility	Expert

### 6.7.17 Stream Channel Count

Indicates the number of streaming channels supported by the device.

Property	Value
Name	DeviceStreamChannelCount
Interface	Integer
Access	RO
Unit	
Visibility	Expert

### 6.7.18 Event Channel Count

Indicates the number of event channels supported by the device.

Property	Value
Name	DeviceEventChannelCount
Interface	Integer

Property	Value
Access	RO
Unit	
Visibility	Expert

### 6.7.19 Character Set

Character set used by the strings of the device's bootstrap registers.

Property	Value
Name	DeviceCharacterSet
Interface	IEnumeration
Access	RO
Visibility	Guru

#### Enumeration Values

UTF8

ASCII

### 6.7.20 Device Reset

This is a command that immediately resets and reboots the device.

Property	Value
Name	DeviceReset
Interface	ICommand
Access	WO
Visibility	Guru

### 6.7.21 Device Indicator Mode

Controls the LED behaviour: Inactive (off), Active (current status), or Error Status (off unless an error occurs).

Property	Value
<b>Name</b>	DeviceIndicatorMode
<b>Interface</b>	IEnumeration
<b>Access</b>	
<b>Visibility</b>	Expert

**Enumeration Values**

Inactive
Active
ErrorStatus

### 6.7.22 Registers Endianness

Endianness of the registers of the device.

Property	Value
<b>Name</b>	DeviceRegistersEndianness
<b>Interface</b>	IEnumeration
<b>Access</b>	RO
<b>Visibility</b>	Guru

**Enumeration Values**

Little
Big

### 6.7.23 Device Temperature Selector

Selects the location within the device, where the temperature will be measured.

Property	Value
<b>Name</b>	DeviceTemperatureSelector
<b>Interface</b>	IEnumeration
<b>Access</b>	



Property	Value
Visibility	Expert

#### Enumeration Values

Sensor
--------

## 6.7.24 Device Temperature

Device temperature in degrees Celsius (C).

Property	Value
Name	DeviceTemperature <a href="#">[Device Temperature Selector]</a>
Interface	IFloat
Access	RO
Unit	C
Visibility	Expert

## 6.7.25 Timestamp Reset

Resets the current value of the device timestamp counter.

Property	Value
Name	TimestampReset
Interface	ICommand
Access	WO
Visibility	Expert

## 6.7.26 Timestamp Latch

Latches the current timestamp counter into TimestampLatchValue.

Property	Value
Name	TimestampLatch
Interface	ICommand

Property	Value
Access	WO
Visibility	Expert

### 6.7.27 Timestamp Latch Value

Returns the latched value of the timestamp counter.

Property	Value
Name	TimestampLatchValue
Interface	Integer
Access	RO
Unit	ns
Visibility	Expert

### 6.7.28 Device Power Supply Selector

Selects the power supply source to control or read.

Property	Value
Name	DevicePowerSupplySelector
Interface	IEnumeration
Access	
Visibility	Expert

#### Enumeration Values

External
----------

### 6.7.29 Power Supply Voltage

Indicates the current voltage of the selected power supply (V).

Property	Value
Name	PowerSupplyVoltage <a href="#">[Device Power Supply Selector]</a>

Property	Value
Interface	IFloat
Access	RO
Unit	V
Visibility	Expert

### 6.7.30 Power Supply Current

Indicates the output current of the selected power supply (A).

Property	Value
Name	PowerSupplyCurrent <a href="#">[Device Power Supply Selector]</a>
Interface	IFloat
Access	RO
Unit	A
Visibility	Expert

### 6.7.31 Device Uptime

Total time since the device was powered up in seconds.

Property	Value
Name	DeviceUptime
Interface	Integer
Access	RO
Unit	s
Visibility	Expert

### 6.7.32 Link Uptime

Time since the last phy negotiation (enumeration).

Property	Value
Name	LinkUptime

Property	Value
Interface	Integer
Access	RO
Unit	s
Visibility	Expert

### 6.7.33 Enumeration Count

Number of enumerations since uptime.

Property	Value
Name	EnumerationCount
Interface	Integer
Access	RO
Unit	
Visibility	Expert

### 6.7.34 Factory Reset

Returns all user tables to factory default

Property	Value
Name	FactoryReset
Interface	ICommand
Access	WO
Visibility	Guru

### 6.7.35 Max Device Reset Time

Time to wait until device reset complete (ms).

Property	Value
Name	MaxDeviceResetTime
Interface	Integer

Property	Value
Access	RO
Unit	ms
Visibility	Expert

# 7 Transport Layer Control

The Transport Layer control provides the following information:

**GeV IEEE 1588** - Enables IEEE 1588 Precision Time Protocol (PTP) to control the timestamp register.

**GeV IEEE 1588 Clock Accuracy** - The expected accuracy of the device clock when it is the grandmaster or when it becomes the grandmaster.

**GeV IEEE 1588 Status** - The status of the IEEE 1588 clock.

**GeV IEEE 1588 Mode** - The mode of the IEEE 1588 clock.

## 7.1 Summary Table

Name	Interface	Access	Visibility	Description
<a href="#">Payload Size</a>	Integer		Expert	Provides the number of bytes transferred for each image or chunk on the stream channel.
<a href="#">GigE Vision</a>	ICategory	RO	Beginner	Category that contains the features pertaining to the GigE Vision transport layer of the device.
<a href="#">Link Error Count</a>	Integer	RO	Expert	Counts the number of error on the link.
<a href="#">Packet Resend Request Count</a>	Integer	RO	Expert	Counts the number of resend requests received from the host.
<a href="#">Packet Resend Requests Dropped Count</a>	Integer	RO	Expert	Counts the number of resend requests that were not processed due to an error condition.

## 7.2 Transport Layer Control Features

### 7.2.1 Payload Size

Provides the number of bytes transferred for each image or chunk on the stream channel.

Property	Value
<b>Name</b>	PayloadSize
<b>Interface</b>	Integer
<b>Access</b>	

Property	Value
Unit	
Visibility	Expert

## 7.2.2 GigE Vision

Category that contains the features pertaining to the GigE Vision transport layer of the device.

Property	Value
Name	GigEVision
Interface	ICategory
Access	RO
Visibility	Beginner

## 7.2.3 Link Error Count

Counts the number of error on the link.

Property	Value
Name	LinkErrorCount
Interface	Integer
Access	RO
Unit	
Visibility	Expert

## 7.2.4 Packet Resend Request Count

Counts the number of resend requests received from the host.

Property	Value
Name	PacketResendRequestCount
Interface	Integer
Access	RO
Unit	
Visibility	Expert

## 7.2.5 Packet Resend Requests Dropped Count

Counts the number of resend requests that were not processed due to an error condition.

Property	Value
<b>Name</b>	PacketResendRequestsDroppedCount
<b>Interface</b>	Integer
<b>Access</b>	RO
<b>Unit</b>	
<b>Visibility</b>	Expert

## 7.3 GigE Vision

Category that contains the features pertaining to the GigE Vision transport layer of the device.

### 7.3.1 Summary Table

Name	Interface	Access	Visibility	Description
<a href="#">Supported Option Selector</a>	IEnumeration	RW	Expert	Selects the GEV option to interrogate for existing support.
<a href="#">Supported Option [Supported Option Selector]</a>	IBoolean	RO	Expert	Returns if the selected GEV option is supported.
<a href="#">Interface Selector</a>	Integer	RW	Beginner	Selects which logical link to control.
<a href="#">MAC Address [Interface Selector]</a>	Integer		Beginner	MAC address of the logical link.
<a href="#">Current IP Configuration LLA [Interface Selector]</a>	IBoolean	RW	Beginner	Controls whether the Link Local Address IP configuration scheme is activated on the given logical link.
<a href="#">Current IP Configuration DHCP [Interface Selector]</a>	IBoolean	RW	Beginner	Controls whether the DHCP IP configuration scheme is activated on the given logical link.



Name	Interface	Access	Visibility	Description
<a href="#">Current IP Configuration Persistent IP [Interface Selector]</a>	IBoolean	RW	Beginner	Controls whether the PersistentIP configuration scheme is activated on the given logical link.
<a href="#">Current IP Address [Interface Selector]</a>	Integer	RO	Beginner	Reports the IP address for the given logical link.
<a href="#">Current Subnet Mask [Interface Selector]</a>	Integer	RO	Beginner	Reports the subnet mask of the given logical link.
<a href="#">Current Default Gateway [Interface Selector]</a>	Integer	RO	Beginner	Reports the default gateway IP address to be used on the given logical link.
<a href="#">First URL</a>	IStringReg		Guru	The first choice of URL for the XML device description file.
<a href="#">Second URL</a>	IStringReg		Guru	The second choice of URL to the XML device description file.
<a href="#">Number Of Interfaces</a>	Integer	RO	Expert	Indicates the number of physical network interfaces supported by this device.
<a href="#">Persistent IP Address [Interface Selector]</a>	Integer		Beginner	Controls the Persistent IP address for this logical link.
<a href="#">Persistent Subnet Mask [Interface Selector]</a>	Integer		Beginner	Controls the Persistent subnet mask associated with the Persistent IP address on this logical link.
<a href="#">Persistent Default Gateway [Interface Selector]</a>	Integer		Beginner	Controls the persistent default gateway for this logical link.
<a href="#">Heartbeat Timeout</a>	Integer		Guru	Indicates the current heartbeat timeout in milliseconds.
<a href="#">Timestamp Tick Frequency</a>	Integer	RO	Expert	Indicates the number of timestamp ticks in 1 second (frequency in Hz).
<a href="#">Pending</a>	IBoolean	RW	Guru	Enables the generation of PENDING_ACK.

Name	Interface	Access	Visibility	Description
<a href="#">Acknowledge Enable</a>				
<a href="#">Heartbeat Disable</a>	IBoolean	RW	Expert	Disables the GVCP heartbeat.
<a href="#">Pending Timeout</a>	IInteger	RO	Guru	Indicates the longest GVCP command execution time before the device returns a PENDING_ACK in milliseconds.
<a href="#">IEEE 1588</a>	IBoolean	RW	Expert	Enables the IEEE 1588 Precision Time Protocol to control the timestamp register.
<a href="#">IEEE 1588 Clock Accuracy</a>	IEnumeration	RO	Expert	Indicates the expected accuracy of the device clock when it is the grandmaster, or in the event it becomes the grandmaster.
<a href="#">IEEE 1588 Status</a>	IEnumeration	RO	Expert	Provides the status of the IEEE 1588 clock.
<a href="#">CCP</a>	IEnumeration	RW	Guru	Controls the device access privilege of an application.
<a href="#">MCP Host Port</a>	IInteger	RW	Guru	The port to which the device must send messages
<a href="#">Message Channel Destination Address</a>	IInteger	RW	Guru	Controls the destination IP address of the message channel
<a href="#">Message Channel Transmission Timeout</a>	IInteger	RO	Guru	Indicates the transmission timeout of the message channel.
<a href="#">Message Channel Retry Count</a>	IInteger	RO	Guru	Indicates the number of retries of the message channel.
<a href="#">Message Channel Source Port</a>	IInteger	RO	Guru	Indicates the source port of the message channel.
<a href="#">Stream Channel Selector</a>	IInteger		Expert	Selects the stream channel to control.
<a href="#">SCCFG Unconditional Streaming [Stream</a>	IBoolean	RW	Guru	Enables the camera to continue to stream, for this stream channel, if its control channel is closed or regardless of the reception of any ICMP messages (such as destination unreachable messages).

Name	Interface	Access	Visibility	Description
<a href="#">Channel Selector</a>				
<a href="#">Gev SCCFG Extended Chunk Data [Stream Channel Selector]</a>	IBoolean	RW	Guru	Enables cameras to use the extended chunk data payload type for this stream channel.
<a href="#">SCP Direction [Stream Channel Selector]</a>	IInteger	RO	Guru	Transmit or Receive of the channel
<a href="#">SCP Interface Index [Stream Channel Selector]</a>	IInteger	RO	Guru	Index of the logical link to use.
<a href="#">SCP Host Port [Stream Channel Selector]</a>	IInteger	RW	Guru	Controls the port of the selected channel to which a GVSP transmitter must send data stream or the port from which a GVSP receiver may receive data stream.
<a href="#">SCPS Fire Test Packet [Stream Channel Selector]</a>	IBoolean	RW	Guru	Sends a test packet.
<a href="#">SCPS Do Not Fragment [Stream Channel Selector]</a>	IBoolean	RW	Guru	The state of this feature is copied into the "do not fragment" bit of the IP header of each stream packet.
<a href="#">SCPS Big Endian [Stream Channel Selector]</a>	IBoolean	RW	Guru	Endianess of multi-byte pixel data for this stream.
<a href="#">SCPS Packet Size [Stream Channel Selector]</a>	IInteger	RW	Expert	Specifies the stream packet size (in bytes) to send on this channel.
<a href="#">Stream Channel Packet Delay [Stream Channel Selector]</a>	IInteger	RW	Expert	Controls the delay (in GEV timestamp counter unit) to insert between each packet for this stream channel. This can be used as a crude flow-control mechanism if the application or the network infrastructure cannot keep up

Name	Interface	Access	Visibility	Description
				with the packets coming from the device.
<a href="#">Stream Channel Destination Address [Stream Channel Selector]</a>	Integer	RW	Guru	Controls the destination IP address of the selected stream channel to which a GVSP transmitter must send data stream or the destination IP address from which a GVSP receiver may receive data stream.
<a href="#">Stream Channel Source Port [Stream Channel Selector]</a>	Integer	RO	Guru	Indicates the source port of the stream channel.
<a href="#">IEEE 1588 Mode</a>	IEnumeration	RW	Expert	Provides the mode of the IEEE 1588 clock.

## 7.3.2 GigE Vision Features

### 7.3.2.1 Supported Option Selector

Selects the GEV option to interrogate for existing support.

Property	Value
<b>Name</b>	GevSupportedOptionSelector
<b>Interface</b>	IEnumeration
<b>Access</b>	RW
<b>Visibility</b>	Expert

#### Enumeration Values

UserDefinedName
SerialNumber
HeartbeatDisable
LinkSpeed
CCPApplicationSocket

**Enumeration Values**

ManifestTable
TestData
DiscoveryAckDelay
DiscoveryAckDelayWritable
ExtendedStatusCodes
Action
PendingAck
EventData
Event
PacketResend
WriteMem
CommandsConcatenation
IPConfigurationLLA
IPConfigurationDHCP
IPConfigurationPersistentIP
StreamChannelSourceSocket
MessageChannelSourceSocket

**7.3.2.2 Supported Option**

Returns if the selected GEV option is supported.

Property	Value
<b>Name</b>	GevSupportedOption <a href="#">[Supported Option Selector]</a>
<b>Interface</b>	IBoolean
<b>Access</b>	RO
<b>Visibility</b>	Expert

**7.3.2.3 Interface Selector**

Selects which logical link to control.

Property	Value
<b>Name</b>	GevInterfaceSelector
<b>Interface</b>	Integer
<b>Access</b>	RW
<b>Unit</b>	
<b>Visibility</b>	Beginner
<b>Value</b>	0

#### 7.3.2.4 MAC Address

MAC address of the logical link.

Property	Value
<b>Name</b>	GevMACAddress <a href="#">[Interface Selector]</a>
<b>Interface</b>	Integer
<b>Access</b>	
<b>Unit</b>	
<b>Visibility</b>	Beginner

#### 7.3.2.5 Current IP Configuration LLA

Controls whether the Link Local Address IP configuration scheme is activated on the given logical link.

Property	Value
<b>Name</b>	GevCurrentIPConfigurationLLA <a href="#">[Interface Selector]</a>
<b>Interface</b>	Boolean
<b>Access</b>	RW
<b>Visibility</b>	Beginner

#### 7.3.2.6 Current IP Configuration DHCP

Controls whether the DHCP IP configuration scheme is activated on the given logical link.

Property	Value
<b>Name</b>	GevCurrentIPConfigurationDHCP <a href="#">[Interface Selector]</a>

Property	Value
Interface	IBoolean
Access	RW
Visibility	Beginner

### 7.3.2.7 Current IP Configuration Persistent IP

Controls whether the PersistentIP configuration scheme is activated on the given logical link.

Property	Value
Name	GevCurrentIPConfigurationPersistentIP <a href="#">[Interface Selector]</a>
Interface	IBoolean
Access	RW
Visibility	Beginner

### 7.3.2.8 Current IP Address

Reports the IP address for the given logical link.

Property	Value
Name	GevCurrentIPAddress <a href="#">[Interface Selector]</a>
Interface	IInteger
Access	RO
Unit	
Visibility	Beginner

### 7.3.2.9 Current Subnet Mask

Reports the subnet mask of the given logical link.

Property	Value
Name	GevCurrentSubnetMask <a href="#">[Interface Selector]</a>
Interface	IInteger
Access	RO
Unit	
Visibility	Beginner

### 7.3.2.10 Current Default Gateway

Reports the default gateway IP address to be used on the given logical link.

Property	Value
<b>Name</b>	GevCurrentDefaultGateway <a href="#">[Interface Selector]</a>
<b>Interface</b>	Integer
<b>Access</b>	RO
<b>Unit</b>	
<b>Visibility</b>	Beginner

### 7.3.2.11 First URL

The first choice of URL for the XML device description file.

Property	Value
<b>Name</b>	GevFirstURL
<b>Interface</b>	IStringReg
<b>Access</b>	
<b>Visibility</b>	Guru

### 7.3.2.12 Second URL

The second choice of URL to the XML device description file.

Property	Value
<b>Name</b>	GevSecondURL
<b>Interface</b>	IStringReg
<b>Access</b>	
<b>Visibility</b>	Guru

### 7.3.2.13 Number Of Interfaces

Indicates the number of physical network interfaces supported by this device.

Property	Value
<b>Name</b>	GevNumberOfInterfaces
<b>Interface</b>	Integer



Property	Value
Access	RO
Unit	
Visibility	Expert

### 7.3.2.14 Persistent IP Address

Controls the Persistent IP address for this logical link.

Property	Value
Name	GevPersistentIPAddress <a href="#">[Interface Selector]</a>
Interface	Integer
Access	
Unit	
Visibility	Beginner

### 7.3.2.15 Persistent Subnet Mask

Controls the Persistent subnet mask associated with the Persistent IP address on this logical link.

Property	Value
Name	GevPersistentSubnetMask <a href="#">[Interface Selector]</a>
Interface	Integer
Access	
Unit	
Visibility	Beginner

### 7.3.2.16 Persistent Default Gateway

Controls the persistent default gateway for this logical link.

Property	Value
Name	GevPersistentDefaultGateway <a href="#">[Interface Selector]</a>
Interface	Integer
Access	
Unit	

Property	Value
Visibility	Beginner

### 7.3.2.17 Heartbeat Timeout

Indicates the current heartbeat timeout in milliseconds.

Property	Value
Name	GevHeartbeatTimeout
Interface	Integer
Access	
Unit	
Visibility	Guru

### 7.3.2.18 Timestamp Tick Frequency

Indicates the number of timestamp ticks in 1 second (frequency in Hz).

Property	Value
Name	GevTimestampTickFrequency
Interface	Integer
Access	RO
Unit	
Visibility	Expert

### 7.3.2.19 Pending Acknowledge Enable

Enables the generation of PENDING\_ACK.

Property	Value
Name	GevGVCPPendingAck
Interface	Boolean
Access	RW
Visibility	Guru

### 7.3.2.20 Heartbeat Disable

Disables the GVCP heartbeat.

Property	Value
<b>Name</b>	GevGVCPHeartbeatDisable
<b>Interface</b>	IBoolean
<b>Access</b>	RW
<b>Visibility</b>	Expert

### 7.3.2.21 Pending Timeout

Indicates the longest GVCP command execution time before the device returns a PENDING\_ACK in milliseconds.

Property	Value
<b>Name</b>	GevGVCPPendingTimeout
<b>Interface</b>	IInteger
<b>Access</b>	RO
<b>Unit</b>	
<b>Visibility</b>	Guru

### 7.3.2.22 IEEE 1588

Enables the IEEE 1588 Precision Time Protocol to control the timestamp register.

Property	Value
<b>Name</b>	GevIEEE1588
<b>Interface</b>	IBoolean
<b>Access</b>	RW
<b>Visibility</b>	Expert

### 7.3.2.23 IEEE 1588 Clock Accuracy

Indicates the expected accuracy of the device clock when it is the grandmaster, or in the event it becomes the grandmaster.

Property	Value
<b>Name</b>	GevIEEE1588ClockAccuracy
<b>Interface</b>	IEnumeration

Property	Value
Access	RO
Visibility	Expert

**Enumeration Values**

Unknown
---------

### 7.3.2.24 IEEE 1588 Status

Provides the status of the IEEE 1588 clock.

Property	Value
Name	GevIEEE1588Status
Interface	IEnumeration
Access	RO
Visibility	Expert

**Enumeration Values**

Initializing
Faulty
Disabled
Listening
PreMaster
Master
Passive
Uncalibrated
Slave

### 7.3.2.25 CCP

Controls the device access privilege of an application.

**Property Value**

<b>Name</b>	GevCCP
<b>Interface</b>	IEnumeration
<b>Access</b>	RW
<b>Visibility</b>	Guru

**Enumeration Values**

OpenAccess
ExclusiveAccess
ControlAccess

### 7.3.2.26 MCP Host Port

The port to which the device must send messages

**Property Value**

<b>Name</b>	GevMCPHostPort
<b>Interface</b>	Integer
<b>Access</b>	RW
<b>Unit</b>	
<b>Visibility</b>	Guru

### 7.3.2.27 Message Channel Destination Address

Controls the destination IP address of the message channel

**Property Value**

<b>Name</b>	GevMCDA
<b>Interface</b>	Integer
<b>Access</b>	RW
<b>Unit</b>	
<b>Visibility</b>	Guru

### 7.3.2.28 Message Channel Transmission Timeout

Indicates the transmission timeout of the message channel.

Property	Value
<b>Name</b>	GevMCTT
<b>Interface</b>	Integer
<b>Access</b>	RO
<b>Unit</b>	
<b>Visibility</b>	Guru

### 7.3.2.29 Message Channel Retry Count

Indicates the number of retries of the message channel.

Property	Value
<b>Name</b>	GevMCRC
<b>Interface</b>	Integer
<b>Access</b>	RO
<b>Unit</b>	
<b>Visibility</b>	Guru

### 7.3.2.30 Message Channel Source Port

Indicates the source port of the message channel.

Property	Value
<b>Name</b>	GevMCSP
<b>Interface</b>	Integer
<b>Access</b>	RO
<b>Unit</b>	
<b>Visibility</b>	Guru

### 7.3.2.31 Stream Channel Selector

Selects the stream channel to control.

Property	Value
<b>Name</b>	GevStreamChannelSelector
<b>Interface</b>	Integer
<b>Access</b>	
<b>Unit</b>	
<b>Visibility</b>	Expert
<b>Value</b>	0

### 7.3.2.32 SCCFG Unconditional Streaming

Enables the camera to continue to stream, for this stream channel, if its control channel is closed or regardless of the reception of any ICMP messages (such as destination unreachable messages).

Property	Value
<b>Name</b>	GevSCCFGUnconditionalStreaming <a href="#">[Stream Channel Selector]</a>
<b>Interface</b>	IBoolean
<b>Access</b>	RW
<b>Visibility</b>	Guru

### 7.3.2.33 Gev SCCFG Extended Chunk Data

Enables cameras to use the extended chunk data payload type for this stream channel.

Property	Value
<b>Name</b>	GevSCCFGExtendedChunkData <a href="#">[Stream Channel Selector]</a>
<b>Interface</b>	IBoolean
<b>Access</b>	RW
<b>Visibility</b>	Guru

### 7.3.2.34 SCP Direction

Transmit or Receive of the channel

Property	Value
<b>Name</b>	GevSCPDirection <a href="#">[Stream Channel Selector]</a>
<b>Interface</b>	Integer

Property	Value
Access	RO
Unit	
Visibility	Guru

### 7.3.2.35 SCP Interface Index

Index of the logical link to use.

Property	Value
Name	GevSCPInterfaceIndex <a href="#">[Stream Channel Selector]</a>
Interface	Integer
Access	RO
Unit	
Visibility	Guru

### 7.3.2.36 SCP Host Port

Controls the port of the selected channel to which a GVSP transmitter must send data stream or the port from which a GVSP receiver may receive data stream.

Property	Value
Name	GevSCPHostPort <a href="#">[Stream Channel Selector]</a>
Interface	Integer
Access	RW
Unit	
Visibility	Guru

### 7.3.2.37 SCPS Fire Test Packet

Sends a test packet.

Property	Value
Name	GevSCPSFireTestPacket <a href="#">[Stream Channel Selector]</a>
Interface	Boolean
Access	RW



Property	Value
Visibility	Guru

### 7.3.2.38 SCPS Do Not Fragment

The state of this feature is copied into the "do not fragment" bit of the IP header of each stream packet.

Property	Value
Name	GevSCPSDoNotFragment <a href="#">[Stream Channel Selector]</a>
Interface	IBoolean
Access	RW
Visibility	Guru

### 7.3.2.39 SCPS Big Endian

Endianess of multi-byte pixel data for this stream.

Property	Value
Name	GevSCPSBigEndian <a href="#">[Stream Channel Selector]</a>
Interface	IBoolean
Access	RW
Visibility	Guru

### 7.3.2.40 SCPS Packet Size

Specifies the stream packet size (in bytes) to send on this channel.

Property	Value
Name	GevSCSPPacketSize <a href="#">[Stream Channel Selector]</a>
Interface	IInteger
Access	RW
Unit	
Visibility	Expert

### 7.3.2.41 Stream Channel Packet Delay

Controls the delay (in GEV timestamp counter unit) to insert between each packet for this stream channel. This can be used as a crude flow-control mechanism if the application or the network

infrastructure cannot keep up with the packets coming from the device.

Property	Value
<b>Name</b>	GevSCPD <a href="#">[Stream Channel Selector]</a>
<b>Interface</b>	Integer
<b>Access</b>	RW
<b>Unit</b>	
<b>Visibility</b>	Expert

### 7.3.2.42 Stream Channel Destination Address

Controls the destination IP address of the selected stream channel to which a GVSP transmitter must send data stream or the destination IP address from which a GVSP receiver may receive data stream.

Property	Value
<b>Name</b>	GevSCDA <a href="#">[Stream Channel Selector]</a>
<b>Interface</b>	Integer
<b>Access</b>	RW
<b>Unit</b>	
<b>Visibility</b>	Guru

### 7.3.2.43 Stream Channel Source Port

Indicates the source port of the stream channel.

Property	Value
<b>Name</b>	GevSCSP <a href="#">[Stream Channel Selector]</a>
<b>Interface</b>	Integer
<b>Access</b>	RO
<b>Unit</b>	
<b>Visibility</b>	Guru

### 7.3.2.44 IEEE 1588 Mode

Provides the mode of the IEEE 1588 clock.

Property	Value
<b>Name</b>	GevIEEE1588Mode
<b>Interface</b>	IEnumeration
<b>Access</b>	RW
<b>Visibility</b>	Expert

#### Enumeration Values

Auto
SlaveOnly

## 8 Sequencer Control

The purpose of a sequencer is to allow you to programmatically control the acquisition parameters of an image sequence. You can define not only how the images are captured (i.e. the camera feature settings) but also when the camera transitions from one acquisition setting to another. This is akin to a state machine diagram where the states correspond to the sequencer set feature settings, and the transition among states corresponds to a particular event that triggers the state machine to move from one state to another.

The features to configure and deploy the sequencer are grouped under the Sequencer Control category.

### 8.1 Sequenced Feature Settings

The feature settings used in a sequence set are a combination of the features specifically configured for the set and what was active when the set was saved. Because many of the camera features are dependently linked to each other, settings may be saved to a set that are outside of the sequencer configuration.

Sequencer features can be classified as follows:

**Direct** - direct features are those you define as being part of the set with specified values which may vary from one set to another and are independently recorded for each set. Examples include: exposure time, gain, resolution, and offset.

**Implied** - implied features are those that are dependent on the direct features. Their settings are recorded for each set. While you do not define their values as part of the set, they are included so that their values are valid. They can be modified during the configuration of a set, but are locked during sequencer operation.

**Fixed** - fixed features are those that are the preconditions to implied or direct features. These settings are recorded to guarantee the sequenced features are valid. Fixed features have a single value for the entire sequence. This is locked during sequencer configuration and operation.

**Forced** - forced features are those whose settings are predefined. These are automatic features that if enabled would control other features and invalidate the settings. They are forced into the Off (manual) mode during sequencer operation. During sequencer configuration, they are modifiable, to allow you to achieve the desired conditions which can then be recorded for later operation.

**Non-sequenced** - non-sequenced are features that are not controlled or affected by the sequencer.

The following diagram provides an example of a web of features and how they are classified based on the fact that a single feature B has been directly sequenced:

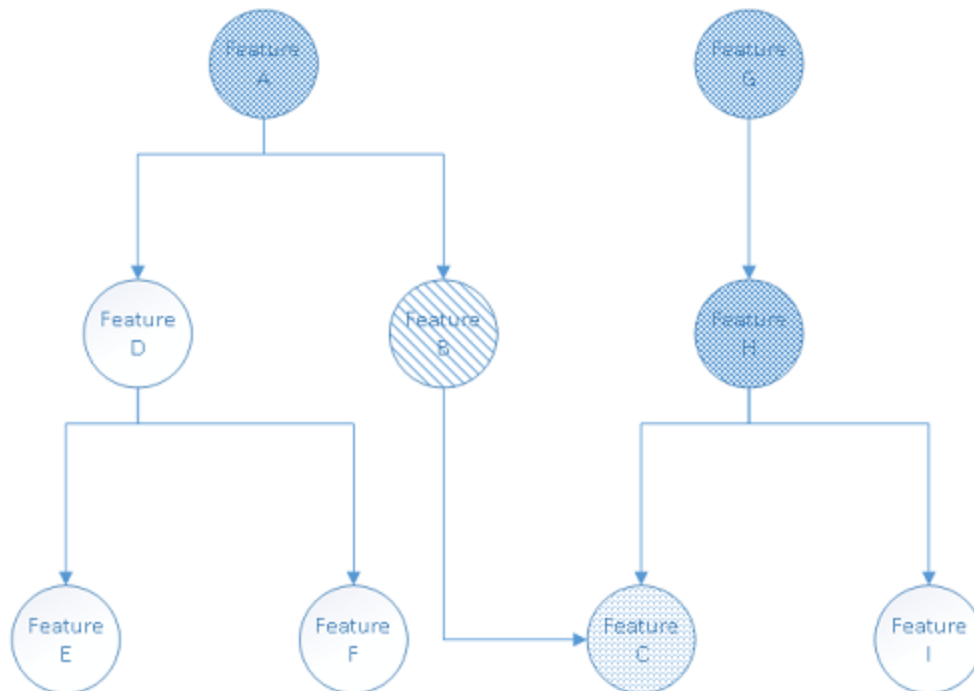

Here is an explanation of how the types of various features are resolved:

- **Direct** - Feature B is the only feature you have requested to be sequenced, making it the sole directly sequenced feature.
- **Implied** - The operational range of feature C is directly affected by feature B, hence it must be sequenced but it is implied only.
- **Fixed** - Feature A controls the operational range of feature B, so it must be fixed to guarantee that the recorded feature B value is legal. Feature C depends on feature H, so it must be fixed. Feature H in turn depends on feature G, so it too must be fixed.
- **Non-sequenced** - Features D, E, and I are not included in the sequence.

## 8.1.1 Sequencer Configuration

The configuration of a sequencer can be broken down into a number of distinct steps :

1. Enable the direct features.

Use the [SequencerFeatureSelector](#) to select which features to directly sequence and set [SequencerFeatureEnable](#) to enabled.

Enabling the direct features must be done prior to entering configuration mode as it determines those features that are defined, implied, fixed, and forced. The enabled features are active for all sequencer sets.

2. Enter configuration mode.

Set [SequencerConfigurationMode](#) to On.

When you enter configuration mode, the camera determines those features which are implied and fixed and locks the fixed features from being modified. If any fixed features need to be adjusted, exit

configuration mode by setting [SequencerConfigurationMode](#) to Off. Make the necessary modifications and enter configuration mode again.

### 3. Configure the features for each sequencer set.

Use [SequencerSetSelector](#) to choose the set to configure. Adjust the features as needed to achieve the desired image. Use the [SequencerSetSave](#) command to save the settings to the selected sequencer set.

Once a set is saved, the camera checks that all the settings are valid. [SequencerSetValid](#) displays the results of this check. If the sequencer set is not valid, adjust the settings and save the set again.

Note: other previously saved and valid sets may become invalid when a set is saved with a new configuration.

Up to 8 sets can be configured and saved.

Once a sequencer set has been configured and is valid, it can be loaded to the active camera at anytime, just like a [User Set](#). The difference between a User Set and a Sequencer Set is the range of features affected. You can load a sequencer set via [SequencerSetLoad](#) at anytime, not just in configuration mode.

Loading is particularly useful when trying to configure multiple sets which may share a similar setup with only minor differences. In that case, you can load an already configured set, select a different set, modify features that are different, and save.

### 4. Configure the transition between sets.

You must define paths for the sequencer to transition from one set to another. Use [SequencerSetSelector](#) to select the set. Then use [SequencerPathSelector](#) to select the path. The current implementation only support a single path for each set.

This path defines the event that causes the transition and the next set to which that it transitions. Use [SequencerTriggerSource](#) to specify the internal signal or physical input line to use as the trigger source. Use [SequencerTriggerActivation](#) to specify the activation mode of the selected trigger source.

Use [SequencerSetNext](#) to specify which set follows the transition.

Note: The order of steps 3 and 4 is not important, as long as the correct set has been chosen via the [SequencerSetSelector](#).

### 5. Configure the starting set.

Use [SequencerSetStart](#) to define which set begins the sequencer operation when it is executed.

### 6. Exit configuration mode.

Set [SequencerConfigurationMode](#) to Off.

Once you have exited configuration mode, the camera checks that the sequencer configuration is valid. [SequencerConfigurationValid](#) displays the results of this check. If the configuration is not valid, enter configuration mode to adjust the settings.

## 8.1.2 Sequencer Execution

Note: Before you can execute a sequencer session, your sequencer configuration must be valid and your camera must not be streaming.

Set [SequencerMode](#) to On. This locks all sequenced features (direct, implied, fixed, and forced) and loads the starting set.

Start image acquisition. The sequencer transitions from set to set according to your path definitions. [SequencerSetActive](#) displays the current set.

During sequencer execution, all sequenced features (direct, implied, fixed, and forced) are locked as their values are driven by the sequencer. However, you can change any features that are not locked. They behave as per normal operation.

To end the sequencer session, set [SequencerMode](#) to Off. The camera is left in the same state as defined by the last sequencer set.

### 8.1.3 Sequencer Usage Example - Simple features change while acquiring images

In this example, Set 0 and Set 1 are the main sets for the camera to capture images. The directly sequenced features are Exposure Time, Gain, Width. Set 0 is defined to acquire full width images with a long exposure and no gain. Set 1 is defined to acquire half-width images with a shorter exposure and higher gain. The transition between the two sets is defined to be triggered by RisingEdge of FrameStart, meaning that the sequencer should toggle between the two sets grabbing an image based on the feature contents of the corresponding set configuration each time.

Set 0:

- ExposureTime = 4000
- Gain = 1.0
- Width = 1024
- SequencerSetTriggerSource[0] = FrameStart
- SequencerSetTriggerActivation[0] = RisingEdge
- SequencerSetTriggerSource[0] = FrameStart
- SequencerSetNext[0] = 1

Set 1:

- ExposureTime = 2000
- Gain = 2.0
- Width = 512
- SequencerSetTriggerSource[0] = FrameStart
- SequencerSetTriggerActivation[0] = RisingEdge
- SequencerSetTriggerSource[0] = FrameStart
- SequencerSetNext[0] = 0

Sequencer begins execution from Set 0.

The working diagram is shown in the following figure:

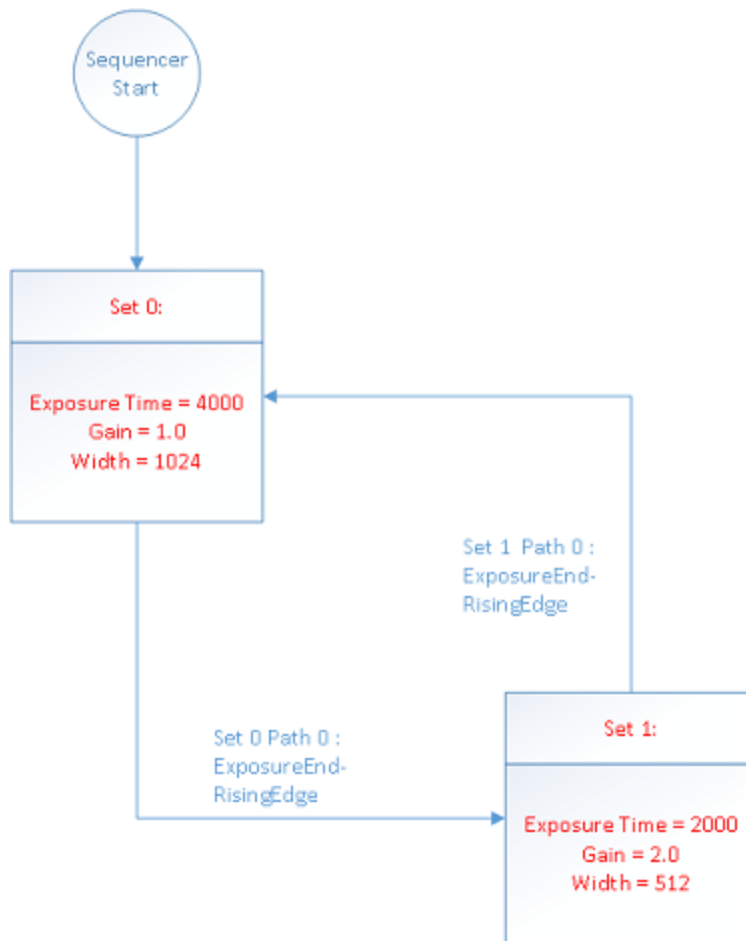

## 8.2 Summary Table

Name	Interface	Access	Visibility	Description
<a href="#">Sequencer Mode</a>	IEnumeration	RW	Expert	Controls whether or not a sequencer is active.
<a href="#">Sequencer Configuration Mode</a>	IEnumeration	RW	Expert	Controls whether or not a sequencer is in configuration mode.
<a href="#">Sequencer Configuration Valid</a>	IEnumeration	RO	Expert	Display whether the current sequencer configuration is valid to run.
<a href="#">Sequencer Feature Selector</a>	IEnumeration	RW	Expert	Selects which sequencer features to control.
<a href="#">Sequencer Feature Enable [Sequencer Feature Selector]</a>	IBoolean	RW	Expert	Enables the selected feature and makes it active in all sequencer sets.



Name	Interface	Access	Visibility	Description
<a href="#">Sequencer Set Start</a>	IInteger	RW	Expert	Sets the first sequencer set to be used.
<a href="#">Sequencer Set Active</a>	IInteger	RO	Expert	Displays the currently active sequencer set.
<a href="#">Sequencer Set Selector</a>	IInteger	RW	Expert	Selects the sequencer set to which subsequent settings apply.
<a href="#">Sequencer Set Valid</a> <a href="#">[Sequencer Set Selector]</a>	IEnumeration	RO	Expert	Displays whether the currently selected sequencer set's register contents are valid to use.
<a href="#">Sequencer Set Save</a> <a href="#">[Sequencer Set Selector]</a>	ICommand	RW	Expert	Saves the current device configuration to the currently selected sequencer set.
<a href="#">Sequencer Set Load</a> <a href="#">[Sequencer Set Selector]</a>	ICommand	RW	Expert	Loads currently selected sequencer to the current device configuration.
<a href="#">Sequencer Path Selector</a> <a href="#">[Sequencer Set Selector]</a>	IInteger	RW	Expert	Selects branching path to be used for subsequent settings.
<a href="#">Sequencer Trigger Source</a> <a href="#">[Sequencer Set Selector]</a> <a href="#">[Sequencer Path Selector]</a>	IEnumeration	RW	Expert	Specifies the internal signal or physical input line to use as the sequencer trigger source.
<a href="#">Sequencer Trigger Activation</a> <a href="#">[Sequencer Set Selector]</a> <a href="#">[Sequencer Path Selector]</a>	IEnumeration	RW	Expert	Specifies the activation mode of the sequencer trigger.
<a href="#">Sequencer Set Next</a> <a href="#">[Sequencer Set Selector]</a> <a href="#">[Sequencer Path Selector]</a>	IInteger	RW	Expert	Specifies the next sequencer set.

## 8.3 Sequencer Control Features

### 8.3.1 Sequencer Mode

Controls whether or not a sequencer is active.

Property	Value
<a href="#">Name</a>	SequencerMode
<a href="#">Interface</a>	IEnumeration

Property	Value
Access	RW
Visibility	Expert

**Enumeration Values**

Off
On

### 8.3.2 Sequencer Configuration Mode

Controls whether or not a sequencer is in configuration mode.

Property	Value
Name	SequencerConfigurationMode
Interface	IEnumeration
Access	RW
Visibility	Expert

**Enumeration Values**

Off
On

### 8.3.3 Sequencer Configuration Valid

Display whether the current sequencer configuration is valid to run.

Property	Value
Name	SequencerConfigurationValid
Interface	IEnumeration
Access	RO
Visibility	Expert

**Enumeration Values**

No
Yes

### 8.3.4 Sequencer Feature Selector

Selects which sequencer features to control.

Property	Value
<b>Name</b>	SequencerFeatureSelector
<b>Interface</b>	IEnumeration
<b>Access</b>	RW
<b>Visibility</b>	Expert

**Enumeration Values**

ExposureTime
Gain

### 8.3.5 Sequencer Feature Enable

Enables the selected feature and makes it active in all sequencer sets.

Property	Value
<b>Name</b>	SequencerFeatureEnable <a href="#">[Sequencer Feature Selector]</a>
<b>Interface</b>	IBoolean
<b>Access</b>	RW
<b>Visibility</b>	Expert

### 8.3.6 Sequencer Set Start

Sets the first sequencer set to be used.

Property	Value
<b>Name</b>	SequencerSetStart
<b>Interface</b>	IInteger

Property	Value
Access	RW
Unit	
Visibility	Expert

### 8.3.7 Sequencer Set Active

Displays the currently active sequencer set.

Property	Value
Name	SequencerSetActive
Interface	Integer
Access	RO
Unit	
Visibility	Expert

### 8.3.8 Sequencer Set Selector

Selects the sequencer set to which subsequent settings apply.

Property	Value
Name	SequencerSetSelector
Interface	Integer
Access	RW
Unit	
Visibility	Expert

### 8.3.9 Sequencer Set Valid

Displays whether the currently selected sequencer set's register contents are valid to use.

Property	Value
Name	SequencerSetValid <a href="#">[Sequencer Set Selector]</a>
Interface	Enumeration

Property	Value
Access	RO
Visibility	Expert

#### Enumeration Values

No
Yes

### 8.3.10 Sequencer Set Save

Saves the current device configuration to the currently selected sequencer set.

Property	Value
Name	SequencerSetSave <a href="#">[Sequencer Set Selector]</a>
Interface	ICommand
Access	RW
Visibility	Expert

### 8.3.11 Sequencer Set Load

Loads currently selected sequencer to the current device configuration.

Property	Value
Name	SequencerSetLoad <a href="#">[Sequencer Set Selector]</a>
Interface	ICommand
Access	RW
Visibility	Expert

### 8.3.12 Sequencer Path Selector

Selects branching path to be used for subsequent settings.

Property	Value
Name	SequencerPathSelector <a href="#">[Sequencer Set Selector]</a>

Property	Value
Interface	IInteger
Access	RW
Unit	
Visibility	Expert

### 8.3.13 Sequencer Trigger Source

Specifies the internal signal or physical input line to use as the sequencer trigger source.

Property	Value
Name	SequencerTriggerSource <a href="#">[Sequencer Set Selector]</a> <a href="#">[Sequencer Path Selector]</a>
Interface	IEnumeration
Access	RW
Visibility	Expert

#### Enumeration Values

Off
FrameStart

### 8.3.14 Sequencer Trigger Activation

Specifies the activation mode of the sequencer trigger.

Property	Value
Name	SequencerTriggerActivation <a href="#">[Sequencer Set Selector]</a> <a href="#">[Sequencer Path Selector]</a>
Interface	IEnumeration
Access	RW
Visibility	Expert

#### Enumeration Values

RisingEdge
------------

**Enumeration Values**

FallingEdge
AnyEdge
LevelHigh
LevelLow

### 8.3.15 Sequencer Set Next

Specifies the next sequencer set.

Property	Value
<b>Name</b>	SequencerSetNext <a href="#">[Sequencer Set Selector]</a> <a href="#">[Sequencer Path Selector]</a>
<b>Interface</b>	Integer
<b>Access</b>	RW
<b>Unit</b>	
<b>Visibility</b>	Expert

# 9 Color Transformation Control

**Note:** To access color transformation controls, ISP must be enabled. The ISP enable feature is under the Image Format control (IspEnable).

A color transformation is a linear operation applied to input red, green, and blue values for each pixel, which are multiplied by a 3x3 matrix and then added to an offset triplet.

The equation, taking input RGB values and producing three output channels (C0, C1 and C2) is given by:

$$\begin{bmatrix} C0_{out} \\ C1_{out} \\ C2_{out} \end{bmatrix} = \begin{bmatrix} Gain00 & Gain01 & Gain02 \\ Gain10 & Gain11 & Gain12 \\ Gain20 & Gain21 & Gain22 \end{bmatrix} \begin{bmatrix} R_{in} \\ G_{in} \\ B_{in} \end{bmatrix} + \begin{bmatrix} Offset0 \\ Offset1 \\ Offset2 \end{bmatrix}$$

There are two available color transformations, RGB to RGB and RGB to YUV.

The RGB to RGB transform takes input in the camera's native RGB color space, which varies based on the properties of the camera and sensor. The RGB to RGB transform is usually used to convert from the camera's native color space to sRGB (standard RGB) color space. This operation is often called a Color Correction Matrix (CCM).

The RGB to RGB transform can be enabled/disabled. Select RGB to RGB with [Color Transformation Selector](#) and then set [Color Transformation Enable](#) to 0 (disabled) or 1 (enabled).

Use the [RGB Transform Light Source](#) to select the active RGB to RGB matrix from a set of pre-calibrated matrices optimized for different lighting conditions.

To set your own RGB to RGB matrix, select Custom [RGB Transform Light Source](#), and then use the features [Color Transformation Value Selector](#) and [Color Transformation Value](#) to set the Gain/Offset coefficients.

The RGB to YUV transform happens after the RGBtoRGB transform and after applying [Gamma](#). It is only available for YUV or YCbCr pixel formats, and it cannot be enabled or disabled, except by changing [Pixel Format](#).

For both RGB to RGB and RGB to YUV, the gain/offset values used can be queried by selecting a value with Color Transformation Value Selector and then reading its Color Transformation Value.

In addition to the RGB to RGB transform, the color of the image can also be adjusted with the [Saturation](#) control, when [Saturation Enable](#) is set to 1. Increasing [Saturation](#) makes the colors in the image more vivid.

## 9.1 Summary Table

Name	Interface	Access	Visibility	Description
<a href="#">Color Transformation</a>	IEnumeration		Beginner	Selects which Color Transformation module is controlled by the various Color



Name	Interface	Access	Visibility	Description
<a href="#">Selector</a>				Transformation features
<a href="#">Color Transformation Enable [Color Transformation Selector]</a>	IBoolean		Beginner	Enables/disables the color transform selected with ColorTransformationSelector. For RGB to YUV this is read-only. Enabling/disabling RGB to YUV can only be done by changing pixel format.
<a href="#">Color Transformation Value Selector [Color Transformation Selector]</a>	IEnumeration			Selects the Gain factor or Offset of the Transformation matrix to access in the selected Color Transformation module
<a href="#">Color Transformation Value [Color Transformation Selector] [Color Transformation Value Selector]</a>	IFloat			Represents the value of the selected Gain factor or Offset inside the Transformation matrix in floating point precision.
<a href="#">RGB Transform Light Source</a>	IEnumeration		Expert	Used to select from a set of RGBtoRGB transform matrices calibrated for different light sources. Selecting a value also sets the white balance ratios (BalanceRatioRed and BalanceRatioBlue), but those can be overwritten through manual or auto white balance.
<a href="#">Saturation Enable</a>	IBoolean		Beginner	Enables/disables Saturation adjustment.
<a href="#">Saturation</a>	IFloat		Beginner	Controls the color saturation.

## 9.2 Color Transformation Control Features

### 9.2.1 Color Transformation Selector

Selects which Color Transformation module is controlled by the various Color Transformation features

Property	Value
<a href="#">Name</a>	ColorTransformationSelector
<a href="#">Interface</a>	IEnumeration

Property	Value
Access	
Visibility	Beginner

**Enumeration Values**

RGBtoRGB
RGBtoYUV

### 9.2.2 Color Transformation Enable

Enables/disables the color transform selected with ColorTransformationSelector. For RGB to YUV this is read-only. Enabling/disabling RGB to YUV can only be done by changing pixel format.

Property	Value
Name	ColorTransformationEnable <a href="#">[Color Transformation Selector]</a>
Interface	IBoolean
Access	
Visibility	Beginner

### 9.2.3 Color Transformation Value Selector

Selects the Gain factor or Offset of the Transformation matrix to access in the selected Color Transformation module

Property	Value
Name	ColorTransformationValueSelector <a href="#">[Color Transformation Selector]</a>
Interface	IEnumeration
Access	
Visibility	

**Enumeration Values**

Gain00
Gain01

## Enumeration Values

Gain02
Gain10
Gain11
Gain12
Gain20
Gain21
Gain22
Offset0
Offset1
Offset2

## 9.2.4 Color Transformation Value

Represents the value of the selected Gain factor or Offset inside the Transformation matrix in floating point precision.

Property	Value
Name	ColorTransformationValue <a href="#">[Color Transformation Selector]</a> <a href="#">[Color Transformation Value Selector]</a>
Interface	IFloat
Access	
Unit	
Visibility	

## 9.2.5 RGB Transform Light Source

Used to select from a set of RGBtoRGB transform matrices calibrated for different light sources. Selecting a value also sets the white balance ratios (BalanceRatioRed and BalanceRatioBlue), but those can be overwritten through manual or auto white balance.

Property	Value
Name	RgbTransformLightSource
Interface	IEnumeration

Property	Value
Access	
Visibility	Expert

**Enumeration Values**

General
Tungsten2800K
WarmFluorescent3000K
CoolFluorescent4000K
Daylight5000K
Cloudy6500K
Shade8000K
Custom

### 9.2.6 Saturation Enable

Enables/disables Saturation adjustment.

Property	Value
Name	SaturationEnable
Interface	IBoolean
Access	
Visibility	Beginner

### 9.2.7 Saturation

Controls the color saturation.

Property	Value
Name	Saturation
Interface	IFloat
Access	

Property	Value
Unit	
Visibility	Beginner

# 10 Auto Algorithm Control

## 10.1 Auto Exposure (AE)

Auto exposure (AE) control is designed to automatically determine the exposure time and gain of the camera so that the resulting image looks as bright as expected. In general, the camera supports various auto exposure features, and these features produce different results in the final image. In addition, the camera allows users to control how fast the exposure and gain get settled.

Note that for AE to work, [Exposure Auto](#) and/or [Gain Auto](#) must be set to Once or Continuous.

### 10.1.1 Auto Exposure Features

To enable AE, [Exposure Auto](#) and/or [Gain Auto](#) must be set to Once or Continuous. AE automatically determines the exposure time and/or gain according to the target image average.

The target image average can be manually or automatically controlled.

For manual control, set [Target Grey Value Auto](#) to Continuous and then set the desired image average in [Target Grey Value](#). This value is a percentage of the maximum pixel value.

For automatic control, set [Target Grey Value Auto](#) to Off. The target image average is then automatically determined according to user-defined AE modes and other AE features.

By default, AE uses the full range of exposure time and/or gain and target grey value, but these can be limited.

[Exposure Time Lower Limit](#) / [Exposure Time Upper Limit](#) - the lower and upper values in microseconds ( $\mu\text{s}$ ) that the exposure time may reach when exposure is set to Once or Continuous.

[Gain Lower Limit](#) / [Gain Upper Limit](#) - the lower and upper values in decibels (dB) that the gain may reach when gain is set to Once or Continuous.

[Target Grey Value Lower Limit](#) / [Target Grey Value Upper Limit](#) - the lower and upper values in percent (%) that the target image average may reach.

[Auto Exposure Damping](#) controls how fast the exposure and gain get settled. A small damping value may result in the system being unstable. The range is from 0.0 - 1.0. The default value is 0.5.

If both exposure time and gain are set to Once or Continuous AE determines which to adjust first by the [Auto Exposure Control Priority](#).

If gain priority is selected, the camera sets the gain to 0 dB, and the exposure is adjusted according to the target grey level. If the maximum exposure is reached before the target grey level is hit, the gain starts to change to meet the target. This mode is used to have the minimum noise.

If exposure priority is selected, the camera sets the exposure to a small value (default is 5 ms). The gain is adjusted according to the target grey level. If maximum gain is reached before the target grey level is hit, the exposure starts to change to meet the target. This mode is used to capture fast motion.

AE Lighting Mode can compensate for strong light sources in front or behind an object. The options are: Backlight, Frontlight, or Normal. The default lighting mode is Normal. Use the [Lighting Mode](#) feature to select depending on your conditions.

#### 10.1.1.1 Backlight Compensation

The backlight compensation mode is used when a strong light is coming from the back of the object. For example, people standing in the shade with the bright sky at the back. A regular auto exposure algorithm makes the object underexposed in such lighting conditions. Backlight compensation is able to properly expose the object when a strong backlight occurs, regardless of the locations of the object relative to the frame.

#### 10.1.1.2 Excessive Frontlight Compensation

The excessive frontlight compensation mode is used when a strong light is shining in the front of the object while the background is dark. For example, a parking spot that has lights on at night while its surrounding areas are very dark. A regular auto exposure algorithm makes the object overexposed in such lighting conditions. Frontlight compensation is able to properly expose the object when a strong front light and a dark background appear, regardless of the locations of the object relative to the frame.

#### 10.1.1.3 Normal Lighting

If the object of interest in the frame is not under backlight or frontlight conditions, then normal lighting should be used. Select Normal lighting mode to make Metering Mode available.

AE Metering Mode is available only if [Lighting Mode](#) is set to Normal. The options are: Average, Spot, and Partial. The default AE metering mode is Average. Use the [Metering Mode](#) feature to select depending on your conditions.

#### 10.1.1.4 Average Metering

This mode measures the light from the entire scene uniformly to determine the final exposure value. Every portion of the exposed area has the same contribution.

#### 10.1.1.5 Spot Metering

This mode measures the light from a small area (about 3%) in the center of the scene while the rest of the scene is ignored. This mode is used when the scene has a high contrast and the object of interest is relatively small.

#### 10.1.1.6 Partial Metering

This mode measures the light from a larger area (about 11%) in the center of the scene. This mode is used when very dark or bright regions appear at the edge of the frame.

A region of interest (ROI) can be applied to the auto exposure features. This AE ROI can be equal to or smaller than the area of the captured ROI. To use AE ROI:

1. Set the [ROI Selector](#) to Auto Exposure.
2. Turn on [ROI Enable](#).
3. Set the horizontal and vertical offsets (relative to the ROI being captured) with [ROI Offset X](#) and [ROI Offset Y](#).
4. Set the width and height with [ROI Width](#) and [ROI Height](#).

[EV Compensation](#) allows you to adjust the resultant image intensity with one control. Positive EV compensation makes the image brighter while negative EV compensation makes the image darker. The range is from -3 to 3 with a step of 1/3. The default value is 0.

## 10.2 Auto White Balance

When [White Balance Auto](#) is set to Continuous or Once the camera automatically adjusts the values of [Balance Ratio](#) Red and Blue to achieve good color balance. It is used to compensate for color shifts in the image caused by different lighting conditions.

There are two profiles of auto white balance: Indoor and Outdoor. These are selected with [White Balance Auto Profile](#).

In the Outdoor profile, the values of the red and blue balance ratios are restricted to a set of expected values for normal outdoor lighting conditions (i.e., daylight).

In the Indoor profile, the values of the red and blue balance ratios can take any values within specified limits. This allows auto white balance to compensate for artificial lighting such as fluorescent lights that are more greenish than daylight. The Indoor profile can also be used for outdoor conditions, since it does not place restrictions on the white balance solution.

By default, auto white balance uses the full range of balance ratios, but these can be limited.

- [White Balance Auto Lower Limit](#) / [White Balance Auto Upper Limit](#) - the lower and upper values that auto white balance can set for the red and blue balance ratios.

[White Balance Auto Damping](#) controls the speed at which auto white balance adjusts the values of the red and blue balance ratios. The range is from 0 to 1. Higher values of damping result in the white balance changing more gradually.

By default auto white balance examines all of the pixels in the image, but it can also use a region of interest (ROI). A common use for an auto white balance ROI is placing a white object in the image and then specifying the ROI on that object. To use ROI:

1. Set the [ROI Selector](#) to Auto White Balance.
2. Turn on [ROI Enable](#).
3. Set the horizontal and vertical offsets (relative to the ROI being captured) with [ROI Offset X](#) and [ROI Offset Y](#).
4. Set the width and height with [ROI Width](#) and [ROI Height](#).

## 10.3 Summary Table

Name	Interface	Access	Visibility	Description
<a href="#">ROI Selector</a>	IEnumeration		Beginner	Selects which Auto Algorithm is controlled by the RoiEnable, OffsetX, OffsetY, Width, Height features.
<a href="#">ROI Enable</a> <a href="#">[ROI Selector]</a>	IBoolean		Guru	Controls whether a user-specified ROI is used for auto algorithm that is currently selected by the AutoAlgorithmSelector feature.



Name	Interface	Access	Visibility	Description
<a href="#">ROI Offset X</a> <a href="#">[ROI Selector]</a>	Integer		Guru	Controls the x-offset of the ROI used by the auto algorithm that is currently selected by the AutoAlgorithmSelector feature.
<a href="#">ROI Offset Y</a> <a href="#">[ROI Selector]</a>	Integer		Guru	Controls the y-offset of the ROI used by the auto algorithm that is currently selected by the AutoAlgorithmSelector feature.
<a href="#">ROI Width</a> <a href="#">[ROI Selector]</a>	Integer		Guru	Controls the width of the ROI used by the auto algorithm that is currently selected by the AutoAlgorithmSelector feature.
<a href="#">ROI Height</a> <a href="#">[ROI Selector]</a>	Integer		Guru	Controls the width of the ROI used by the auto algorithm that is currently selected by the AutoAlgorithmSelector feature.
<a href="#">White Balance Auto Profile</a>	Enumeration	RW	Expert	Selects the profile used by BalanceWhiteAuto.
<a href="#">White Balance Auto Lower Limit</a>	Float		Expert	Controls the minimum value Auto White Balance can set for the Red/Blue BalanceRatio.
<a href="#">White Balance Auto Upper Limit</a>	Float		Expert	Controls the maximum value Auto White Balance can set the Red/Blue BalanceRatio.
<a href="#">White Balance Auto Damping</a>	Float		Expert	Controls how quickly 'BalanceWhiteAuto' adjusts the values for Red and Blue BalanceRatio in response to changing conditions. Higher damping means the changes are more gradual.
<a href="#">Target Grey Value Auto</a>	Enumeration		Beginner	This indicates whether the target image grey level is automatically set by the camera or manually set by the user. Note that the target grey level is in the linear domain before gamma correction is applied.
<a href="#">Target Grey Value</a>	Float	RW		This is the user-specified target grey level (image mean) to apply to the current image. Note that the target grey level is in the linear domain before gamma correction is applied.
<a href="#">Lighting Mode</a>	Enumeration	RW	Beginner	Selects a lighting mode: Backlight, Frontlight or Normal (default). a. Backlight compensation: used when a strong light is coming from the back of the object. b. Frontlight compensation: used when a strong light is shining in the front of the object while the background is dark. c. Normal lighting: used when the object is not

Name	Interface	Access	Visibility	Description
				under backlight or frontlight conditions. When normal lighting is selected, metering modes are available.
<a href="#">Metering Mode</a>	IEnumeration	RW	Beginner	Selects a metering mode: average, spot, or partial metering. a. Average: Measures the light from the entire scene uniformly to determine the final exposure value. Every portion of the exposed area has the same contribution. b. Spot: Measures a small area (about 3%) in the center of the scene while the rest of the scene is ignored. This mode is used when the scene has a high contrast and the object of interest is relatively small. c. Partial: Measures the light from a larger area (about 11%) in the center of the scene. This mode is used when very dark or bright regions appear at the edge of the frame. Note: Metering mode is available only when Lighting Mode Selector is Normal.
<a href="#">Exposure Time Lower Limit</a>	IFloat	RW		The smallest exposure time that auto exposure can set.
<a href="#">Exposure Time Upper Limit</a>	IFloat	RW		The largest exposure time that auto exposure can set.
<a href="#">Gain Lower Limit</a>	IFloat	RW		The smallest gain that auto exposure can set.
<a href="#">Gain Upper Limit</a>	IFloat	RW		The largest gain that auto exposure can set.
<a href="#">Target Grey Value Lower Limit</a>	IFloat	RW		The lowest value in percentage that the target mean may reach.
<a href="#">Target Grey Value Upper Limit</a>	IFloat	RW		The highest value in percentage that the target mean may reach.
<a href="#">EV Compensation</a>	IFloat	RW	Beginner	The EV compensation value used in the exposure compensation. This allows you to adjust the resultant image intensity with one control. A positive value makes the image brighter. A negative value makes the image darker. Range from -3 to 3 with a step of 1/3. Default = 0.
<a href="#">Auto</a>	IFloat	RW	Beginner	It controls how fast the exposure and gain get

Name	Interface	Access	Visibility	Description
<a href="#">Exposure Damping</a>				settled. If the value is too small, it may cause the system to be unstable. Range is from 0.0 to 1.0. Default = 0.2.
<a href="#">Auto Exposure Control Priority</a>	IEnumeration	RW	Beginner	Selects whether to adjust gain or exposure first. When gain priority is selected, the camera fixes the gain to 0 dB, and the exposure is adjusted according to the target grey level. If the maximum exposure is reached before the target grey level is hit, the gain starts to change to meet the target. This mode is used to have the minimum noise. When exposure priority is selected, the camera sets the exposure to a small value (default is 5 ms). The gain is adjusted according to the target grey level. If maximum gain is reached before the target grey level is hit, the exposure starts to change to meet the target. This mode is used to capture fast motion.

## 10.4 Auto Algorithm Control Features

### 10.4.1 ROI Selector

Selects which Auto Algorithm is controlled by the RoiEnable, OffsetX, OffsetY, Width, Height features.

Property	Value
<b>Name</b>	AutoAlgorithmSelector
<b>Interface</b>	IEnumeration
<b>Access</b>	
<b>Visibility</b>	Beginner

#### Enumeration Values

Awb
Ae

## 10.4.2 ROI Enable

Controls whether a user-specified ROI is used for auto algorithm that is currently selected by the AutoAlgorithmSelector feature.

Property	Value
<b>Name</b>	AasRoiEnable <a href="#">[ROI Selector]</a>
<b>Interface</b>	IBoolean
<b>Access</b>	
<b>Visibility</b>	Guru

## 10.4.3 ROI Offset X

Controls the x-offset of the ROI used by the auto algorithm that is currently selected by the AutoAlgorithmSelector feature.

Property	Value
<b>Name</b>	AasRoiOffsetX <a href="#">[ROI Selector]</a>
<b>Interface</b>	IInteger
<b>Access</b>	
<b>Unit</b>	
<b>Visibility</b>	Guru

## 10.4.4 ROI Offset Y

Controls the y-offset of the ROI used by the auto algorithm that is currently selected by the AutoAlgorithmSelector feature.

Property	Value
<b>Name</b>	AasRoiOffsetY <a href="#">[ROI Selector]</a>
<b>Interface</b>	IInteger
<b>Access</b>	
<b>Unit</b>	
<b>Visibility</b>	Guru

### 10.4.5 ROI Width

Controls the width of the ROI used by the auto algorithm that is currently selected by the AutoAlgorithmSelector feature.

Property	Value
<b>Name</b>	AasRoiWidth <a href="#">[ROI Selector]</a>
<b>Interface</b>	Integer
<b>Access</b>	
<b>Unit</b>	
<b>Visibility</b>	Guru

### 10.4.6 ROI Height

Controls the width of the ROI used by the auto algorithm that is currently selected by the AutoAlgorithmSelector feature.

Property	Value
<b>Name</b>	AasRoiHeight <a href="#">[ROI Selector]</a>
<b>Interface</b>	Integer
<b>Access</b>	
<b>Unit</b>	
<b>Visibility</b>	Guru

### 10.4.7 White Balance Auto Profile

Selects the profile used by BalanceWhiteAuto.

Property	Value
<b>Name</b>	BalanceWhiteAutoProfile
<b>Interface</b>	Enumeration
<b>Access</b>	RW
<b>Visibility</b>	Expert

### Enumeration Values

Indoor
--------

Outdoor
---------

## 10.4.8 White Balance Auto Lower Limit

Controls the minimum value Auto White Balance can set for the Red/Blue BalanceRatio.

Property	Value
<b>Name</b>	BalanceWhiteAutoLowerLimit
<b>Interface</b>	IFloat
<b>Access</b>	
<b>Unit</b>	
<b>Visibility</b>	Expert

## 10.4.9 White Balance Auto Upper Limit

Controls the maximum value Auto White Balance can set the Red/Blue BalanceRatio.

Property	Value
<b>Name</b>	BalanceWhiteAutoUpperLimit
<b>Interface</b>	IFloat
<b>Access</b>	
<b>Unit</b>	
<b>Visibility</b>	Expert

## 10.4.10 White Balance Auto Damping

Controls how quickly 'BalanceWhiteAuto' adjusts the values for Red and Blue BalanceRatio in response to changing conditions. Higher damping means the changes are more gradual.

Property	Value
<b>Name</b>	BalanceWhiteAutoDamping
<b>Interface</b>	IFloat
<b>Access</b>	

Property	Value
Unit	
Visibility	Expert

### 10.4.11 Target Grey Value Auto

This indicates whether the target image grey level is automatically set by the camera or manually set by the user. Note that the target grey level is in the linear domain before gamma correction is applied.

Property	Value
Name	AutoExposureTargetGreyValueAuto
Interface	IEnumeration
Access	
Visibility	Beginner

#### Enumeration Values

Off

Continuous

### 10.4.12 Target Grey Value

This is the user-specified target grey level (image mean) to apply to the current image. Note that the target grey level is in the linear domain before gamma correction is applied.

Property	Value
Name	AutoExposureTargetGreyValue
Interface	IFloat
Access	RW
Unit	%
Visibility	

### 10.4.13 Lighting Mode

Selects a lighting mode: Backlight, Frontlight or Normal (default). a. Backlight compensation: used when a strong light is coming from the back of the object. b. Frontlight compensation: used when a strong light is shining in the front of the object while the background is dark. c. Normal lighting: used

when the object is not under backlight or frontlight conditions. When normal lighting is selected, metering modes are available.

Property	Value
<b>Name</b>	AutoExposureLightingMode
<b>Interface</b>	IEnumeration
<b>Access</b>	RW
<b>Visibility</b>	Beginner

#### Enumeration Values

AutoDetect
Backlight
Frontlight
Normal

### 10.4.14 Metering Mode

Selects a metering mode: average, spot, or partial metering. a. Average: Measures the light from the entire scene uniformly to determine the final exposure value. Every portion of the exposed area has the same contribution. b. Spot: Measures a small area (about 3%) in the center of the scene while the rest of the scene is ignored. This mode is used when the scene has a high contrast and the object of interest is relatively small. c. Partial: Measures the light from a larger area (about 11%) in the center of the scene. This mode is used when very dark or bright regions appear at the edge of the frame. Note: Metering mode is available only when Lighting Mode Selector is Normal.

Property	Value
<b>Name</b>	AutoExposureMeteringMode
<b>Interface</b>	IEnumeration
<b>Access</b>	RW
<b>Visibility</b>	Beginner

#### Enumeration Values

Average
Spot
Partial



### Enumeration Values

CenterWeighted

HistogramPeak

## 10.4.15 Exposure Time Lower Limit

The smallest exposure time that auto exposure can set.

Property	Value
<b>Name</b>	AutoExposureExposureTimeLowerLimit
<b>Interface</b>	IFloat
<b>Access</b>	RW
<b>Unit</b>	us
<b>Visibility</b>	

## 10.4.16 Exposure Time Upper Limit

The largest exposure time that auto exposure can set.

Property	Value
<b>Name</b>	AutoExposureExposureTimeUpperLimit
<b>Interface</b>	IFloat
<b>Access</b>	RW
<b>Unit</b>	us
<b>Visibility</b>	

## 10.4.17 Gain Lower Limit

The smallest gain that auto exposure can set.

Property	Value
<b>Name</b>	AutoExposureGainLowerLimit
<b>Interface</b>	IFloat
<b>Access</b>	RW

Property	Value
Unit	dB
Visibility	

### 10.4.18 Gain Upper Limit

The largest gain that auto exposure can set.

Property	Value
Name	AutoExposureGainUpperLimit
Interface	IFloat
Access	RW
Unit	dB
Visibility	

### 10.4.19 Target Grey Value Lower Limit

The lowest value in percentage that the target mean may reach.

Property	Value
Name	AutoExposureGreyValueLowerLimit
Interface	IFloat
Access	RW
Unit	%
Visibility	

### 10.4.20 Target Grey Value Upper Limit

The highest value in percentage that the target mean may reach.

Property	Value
Name	AutoExposureGreyValueUpperLimit
Interface	IFloat
Access	RW

Property	Value
Unit	%
Visibility	

### 10.4.21 EV Compensation

The EV compensation value used in the exposure compensation. This allows you to adjust the resultant image intensity with one control. A positive value makes the image brighter. A negative value makes the image darker. Range from -3 to 3 with a step of 1/3. Default = 0.

Property	Value
Name	AutoExposureEVCompensation
Interface	IFloat
Access	RW
Unit	
Visibility	Beginner

### 10.4.22 Auto Exposure Damping

It controls how fast the exposure and gain get settled. If the value is too small, it may cause the system to be unstable. Range is from 0.0 to 1.0. Default = 0.2.

Property	Value
Name	AutoExposureControlLoopDamping
Interface	IFloat
Access	RW
Unit	
Visibility	Beginner

### 10.4.23 Auto Exposure Control Priority

Selects whether to adjust gain or exposure first. When gain priority is selected, the camera fixes the gain to 0 dB, and the exposure is adjusted according to the target grey level. If the maximum exposure is reached before the target grey level is hit, the gain starts to change to meet the target. This mode is used to have the minimum noise. When exposure priority is selected, the camera sets the exposure to a small value (default is 5 ms). The gain is adjusted according to the target grey level. If maximum gain is reached before the target grey level is hit, the exposure starts to change to meet the target. This mode is used to capture fast motion.

Property	Value
<b>Name</b>	AutoExposureControlPriority
<b>Interface</b>	IEnumeration
<b>Access</b>	RW
<b>Visibility</b>	Beginner

#### Enumeration Values

Gain
ExposureTime

# 11 Defective Pixel Correction

The camera supports table-based defective pixel correction, where a list of defective pixel coordinates is specified, and the values of those pixels are replaced based on the values of their neighbors. The camera comes with a list of defective pixels calibrated during manufacturing (the factory default table), but you can update or replace this list.

[Defect Correct Static Enable](#) turns table-based defective pixel correction On or Off.

[Defect Correction Mode](#) controls the method used for replacing the value of pixels within the table. The options are Average or Highlight. Average replaces defective pixels with the average of their neighbors. Highlight is used for debugging purposes and sets pixels within the table to the maximum possible pixel value to highlight them.

## 11.1 Modifying the List of Defective Pixels

[Defect Correct Pixel Count](#) controls the number of defective pixels in the table.

[Defect Table Index](#) selects an individual pixel within the table. This is a zero-based index, so if there are  $N$  pixels in the table, the index range is from 0 to  $N-1$ . [Defect X Coordinate](#) and [Defect Y Coordinate](#) define the (X,Y) coordinates of the defective pixel selected by the index. These values can be changed. These (X,Y) coordinates are relative to the full image ROI, when [Offset X](#) and [Offset Y](#) are both zero.

Changes made to the defective pixel table using these controls do NOT take effect immediately. When the you have finished making a series of changes to the table, execute the command [Defect Table Apply](#) for the changes to affect images captured by the camera. This writes the table to volatile memory, so changes are lost if the camera loses power.

[Defect Table Save](#) saves the table to persistent storage within the camera, so that the modified table is loaded whenever the camera boots up. Saving overwrites the existing table stored in memory.

[Defect Table Factory Restore](#) resets the table to its factory default state. This completely overwrites any changes made to the table, both the active table used in images being captured by the camera and the table saved in memory.

**Important Note:** Because it takes time to download a full defect table, if the camera is streaming when a table is either applied or restored to factory default, the results may appear momentarily corrupted until the complete table is written to the FPGA.

### 11.1.1 Example: Adding a location to the Defective Pixel Table

These steps illustrate how to add a pixel to the table:

1. Set [Offset X](#) and [Offset Y](#) to zero, and [Width](#) and [Height](#) at least large enough so that the defective pixel falls within the image ROI.
2. Note the X and Y coordinates of the defective pixel under these ROI settings.
3. Increase [Defect Correct Pixel Count](#) by 1 to add a new defective pixel to the list.

4. Set [Defect Table Index](#) to the new value of [Defect Correct Pixel Count](#) minus 1, to control the last defective pixel in the table, which is the one that was just added.
5. Set the values of [Defect X Coordinate](#) and [Defect Y Coordinate](#) to the coordinates of the pixel being added.
6. Click [Defect Table Apply](#) to have the change affect images being captured.
7. Use [Defect Table Save](#) to save the modified table so that it is loaded every time the camera boots up.

## 11.2 Summary Table

Name	Interface	Access	Visibility	Description
<a href="#">Defect Correct Static Enable</a>	IBoolean		Guru	Enables/Disables table-based defective pixel correction.
<a href="#">Defect Correction Mode</a>	IEnumeration		Guru	Controls the method used for replacing defective pixels.
<a href="#">Defect Table Pixel Count</a>	IInteger		Guru	The number of defective pixel locations in the current table.
<a href="#">Defect Table Index</a>	IInteger		Guru	Controls the offset of the element to access in the defective pixel location table.
<a href="#">Defect X Coordinate [Defect Table Index]</a>	IInteger		Guru	Returns the X coordinate of the defective pixel at DefectTableIndex within the defective pixel table. Changes made do not take effect in captured images until the command DefectTableApply is written.
<a href="#">Defect Y Coordinate [Defect Table Index]</a>	IInteger		Guru	Returns the Y coordinate of the defective pixel at DefectTableIndex within the defective pixel table. Changes made do not take effect in captured images until the command DefectTableApply is written.
<a href="#">Defect Table Apply</a>	ICommand	RW	Guru	Applies the current defect table, so that any changes made affect images captured by the camera. This writes the table to volatile memory, so changes to the table are lost if the camera loses power. To save the table to non-volatile memory, use DefectTableSave.
<a href="#">Defect Table Save</a>	ICommand		Guru	Saves the current defective pixel table non-volatile

Name	Interface	Access	Visibility	Description
				memory, so that it is preserved when the camera boots up. This overwrites the existing defective pixel table. The new table is loaded whenever the camera powers up.
<a href="#">Defect Table Factory Restore</a>	ICommand		Guru	Restores the Defective Pixel Table to its factory default state, which was calibrated during manufacturing. This permanently overwrites any changes made to the defect table.

## 11.3 Defective Pixel Correction Features

### 11.3.1 Defect Correct Static Enable

Enables/Disables table-based defective pixel correction.

Property	Value
<b>Name</b>	DefectCorrectStaticEnable
<b>Interface</b>	IBoolean
<b>Access</b>	
<b>Visibility</b>	Guru

### 11.3.2 Defect Correction Mode

Controls the method used for replacing defective pixels.

Property	Value
<b>Name</b>	DefectCorrectionMode
<b>Interface</b>	IEnumeration
<b>Access</b>	
<b>Visibility</b>	Guru

#### Enumeration Values

Average
Highlight

### Enumeration Values

Zero

## 11.3.3 Defect Table Pixel Count

The number of defective pixel locations in the current table.

Property	Value
<b>Name</b>	DefectTablePixelCount
<b>Interface</b>	Integer
<b>Access</b>	
<b>Unit</b>	
<b>Visibility</b>	Guru

## 11.3.4 Defect Table Index

Controls the offset of the element to access in the defective pixel location table.

Property	Value
<b>Name</b>	DefectTableIndex
<b>Interface</b>	Integer
<b>Access</b>	
<b>Unit</b>	
<b>Visibility</b>	Guru

## 11.3.5 Defect X Coordinate

Returns the X coordinate of the defective pixel at DefectTableIndex within the defective pixel table. Changes made do not take effect in captured images until the command DefectTableApply is written.

Property	Value
<b>Name</b>	DefectTableCoordinateX <a href="#">[Defect Table Index]</a>
<b>Interface</b>	Integer
<b>Access</b>	
<b>Unit</b>	



Property	Value
Visibility	Guru

### 11.3.6 Defect Y Coordinate

Returns the Y coordinate of the defective pixel at DefectTableIndex within the defective pixel table. Changes made do not take effect in captured images until the command DefectTableApply is written.

Property	Value
Name	DefectTableCoordinateY <a href="#">[Defect Table Index]</a>
Interface	Integer
Access	
Unit	
Visibility	Guru

### 11.3.7 Defect Table Apply

Applies the current defect table, so that any changes made affect images captured by the camera. This writes the table to volatile memory, so changes to the table are lost if the camera loses power. To save the table to non-volatile memory, use DefectTableSave.

Property	Value
Name	DefectTableApply
Interface	ICommand
Access	RW
Visibility	Guru

### 11.3.8 Defect Table Save

Saves the current defective pixel table non-volatile memory, so that it is preserved when the camera boots up. This overwrites the existing defective pixel table. The new table is loaded whenever the camera powers up.

Property	Value
Name	DefectTableSave
Interface	ICommand

Property	Value
Access	
Visibility	Guru

### 11.3.9 Defect Table Factory Restore

Restores the Defective Pixel Table to its factory default state, which was calibrated during manufacturing. This permanently overwrites any changes made to the defect table.

Property	Value
Name	DefectTableFactoryRestore
Interface	ICommand
Access	
Visibility	Guru

## 12 User Set Control

Features in the User Set Control category allow you to save camera settings to non-volatile memory so that they can be restored to a known state at any time (after the camera has been restarted).

### 12.1 Types of User Sets

You can select which user set to configure, save, or load with the [UserSetSelector](#) feature. There are two classes of user sets.

- User-defined settings
- Factory-defined settings. A factory-defined Default user set is always available. It represents a typical use case for the camera.

If the factory-defined settings are not ideal, they can be used as a starting point. From there, only a few features may need to be modified to achieve the desired configuration. The [UserSetSave](#) feature saves the current camera settings so that they can be recreated later. Once saved, these new custom settings can be loaded at any time.

The [UserSetLoad](#) feature loads the specified user set. Note that one can load a set without first saving. In this situation, the user set contents are the factory-defined default settings.

### 12.2 Start-up User Set

The [UserSetDefault](#) feature is used to configure a camera automatically at start-up. This loads the selected user set at start-up time. By default, it applies the factory-defined Default settings. However, you can change it to any user set so that the next time the camera restarts, it comes up with the selected user set.

### 12.3 User Set Managed Features

Due to limited on-board non-volatile memory, not all features are supported by user sets. See [UserSetFeatureSelector](#) for the list of all features that are supported. Features that are not listed are either of single session nature or are managed explicitly via other features, such as [Defect Table Save](#).

### 12.4 User Set Conversion

The exact list of features managed by user sets may change between different versions of firmware. Consequently, there may not be a perfect match between the set of features saved to non-volatile memory and the set of features handled by the current version of firmware. In this situation, the camera performs any necessary conversions on all saved user sets. This happens automatically the first time the camera is restarted after a firmware update. The conversion performed depends on the nature of the feature discrepancy:

- Obsolete features - Saved features that are no longer supported in the current firmware. These features are ignored and removed from all subsequently saved user sets.

- Missing features - Saved user sets do not have features that are supported in the current firmware. These missing feature values are filled in using one of the factory-defined sets. If [UserSetDefault](#) points to a user-defined set, then the missing feature values are copied from the factory-defined Default set.

## 12.5 Summary Table

Name	Interface	Access	Visibility	Description
<a href="#">User Set Selector</a>	IEnumeration	RW	Beginner	Selects the feature User Set to load, save or configure.
<a href="#">User Set Load [User Set Selector]</a>	ICommand	RW	Expert	Loads the User Set specified by UserSetSelector to the device and makes it active.
<a href="#">User Set Save [User Set Selector]</a>	ICommand	RW	Beginner	Saves the User Set specified by UserSetSelector to the non-volatile memory of the device.
<a href="#">User Set Default</a>	IEnumeration	RW	Beginner	Selects the feature User Set to load and make active by default when the device is restarted.
<a href="#">User Set Feature Selector</a>	IEnumeration	RW	Expert	List of features that are saved to user sets.
<a href="#">User Set Feature Enable</a>	IBoolean	RO	Expert	Whether or not the selected feature is saved to user sets.

## 12.6 User Set Control Features

### 12.6.1 User Set Selector

Selects the feature User Set to load, save or configure.

Property	Value
<b>Name</b>	UserSetSelector
<b>Interface</b>	IEnumeration
<b>Access</b>	RW
<b>Visibility</b>	Beginner

### Enumeration Values

Default
UserSet0
UserSet1

## 12.6.2 User Set Load

Loads the User Set specified by UserSetSelector to the device and makes it active.

Property	Value
<b>Name</b>	UserSetLoad <a href="#">[User Set Selector]</a>
<b>Interface</b>	ICommand
<b>Access</b>	RW
<b>Visibility</b>	Expert

## 12.6.3 User Set Save

Saves the User Set specified by UserSetSelector to the non-volatile memory of the device.

Property	Value
<b>Name</b>	UserSetSave <a href="#">[User Set Selector]</a>
<b>Interface</b>	ICommand
<b>Access</b>	RW
<b>Visibility</b>	Beginner

## 12.6.4 User Set Default

Selects the feature User Set to load and make active by default when the device is restarted.

Property	Value
<b>Name</b>	UserSetDefault
<b>Interface</b>	IEnumeration
<b>Access</b>	RW
<b>Visibility</b>	Beginner

### Enumeration Values

Default

UserSet0

UserSet1

## 12.6.5 User Set Feature Selector

List of features that are saved to user sets.

Property	Value
<b>Name</b>	UserSetFeatureSelector
<b>Interface</b>	IEnumeration
<b>Access</b>	RW
<b>Visibility</b>	Expert

### Enumeration Values

AasRoiEnableAe

AasRoiEnableAwb

AasRoiHeightAe

AasRoiHeightAwb

AasRoiOffsetXAe

AasRoiOffsetXAwb

AasRoiOffsetYAe

AasRoiOffsetYAwb

AasRoiWidthAe

AasRoiWidthAwb

AcquisitionBurstFrameCount

AcquisitionFrameCount

AcquisitionFrameRate

AcquisitionFrameRateEnable

### Enumeration Values

<b>AcquisitionLineRate</b>
<b>AcquisitionMode</b>
<b>AdcBitDepth</b>
<b>AutoExposureControlLoopDamping</b>
<b>AutoExposureControlPriority</b>
<b>AutoExposureEVCompensation</b>
<b>AutoExposureExposureTimeLowerLimit</b>
<b>AutoExposureExposureTimeUpperLimit</b>
<b>AutoExposureGainLowerLimit</b>
<b>AutoExposureGainUpperLimit</b>
<b>AutoExposureGreyValueLowerLimit</b>
<b>AutoExposureGreyValueUpperLimit</b>
<b>AutoExposureLightingMode</b>
<b>AutoExposureMeteringMode</b>
<b>AutoExposureTargetGreyValue</b>
<b>AutoExposureTargetGreyValueAuto</b>
<b>BalanceRatioBlue</b>
<b>BalanceRatioRed</b>
<b>BalanceWhiteAuto</b>
<b>BalanceWhiteAutoDamping</b>
<b>BalanceWhiteAutoLowerLimit</b>
<b>BalanceWhiteAutoProfile</b>
<b>BalanceWhiteAutoUpperLimit</b>
<b>BinningHorizontalAll</b>
<b>BinningHorizontalMode</b>
<b>BinningVerticalAll</b>
<b>BinningVerticalMode</b>

### Enumeration Values

<b>BlackLevelAll</b>
<b>ChunkEnableAll</b>
<b>ChunkModeActive</b>
<b>ColorTransformationEnable</b>
<b>CounterDelayCounter0</b>
<b>CounterDelayCounter1</b>
<b>CounterDurationCounter0</b>
<b>CounterDurationCounter1</b>
<b>CounterEventActivationCounter0</b>
<b>CounterEventActivationCounter1</b>
<b>CounterEventSourceCounter0</b>
<b>CounterEventSourceCounter1</b>
<b>CounterResetActivationCounter0</b>
<b>CounterResetActivationCounter1</b>
<b>CounterResetSourceCounter0</b>
<b>CounterResetSourceCounter1</b>
<b>CounterTriggerActivationCounter0</b>
<b>CounterTriggerActivationCounter1</b>
<b>CounterTriggerSourceCounter0</b>
<b>CounterTriggerSourceCounter1</b>
<b>DecimationHorizontalAll</b>
<b>DecimationVerticalAll</b>
<b>DefectCorrectStaticEnable</b>
<b>DefectCorrectionMode</b>
<b>DeviceIndicatorMode</b>
<b>DeviceLinkBandwidthReserve</b>
<b>DeviceLinkThroughputLimit</b>



### Enumeration Values

EvCompensationRaw

EventNotificationError

EventNotificationExposureEnd

EventNotificationSerialPortReceive

ExposureActiveMode

ExposureAuto

ExposureMode

ExposureTime

FfcEnable

FfcMode

GainAll

GainAuto

Gamma

GammaEnable

GevSCPD

GevSCPSBigEndian

GevSCPSPDoNotFragment

GevSCPSPacketSize

Height

IspEnable

LUTEnable

LineFilterWidthLine0Debounce

LineFilterWidthLine0Deglitch

LineFilterWidthLine1Debounce

LineFilterWidthLine1Deglitch

LineFilterWidthLine2Debounce

LineFilterWidthLine2Deglitch

### Enumeration Values

LineFilterWidthLine3Debounce
LineFilterWidthLine3Deglitch
LineFilterWidthLine4Debounce
LineFilterWidthLine4Deglitch
LineFilterWidthLine5Debounce
LineFilterWidthLine5Deglitch
LineFilterWidthLine6Debounce
LineFilterWidthLine6Deglitch
LineInverterLine0
LineInverterLine1
LineInverterLine2
LineInverterLine3
LineInverterLine4
LineInverterLine5
LineInverterLine6
LineModelLine0
LineModelLine1
LineModelLine2
LineModelLine3
LineModelLine4
LineModelLine5
LineModelLine6
LineSourceLine0
LineSourceLine1
LineSourceLine2
LineSourceLine3
LineSourceLine4

### Enumeration Values

LineSourceLine5
LineSourceLine6
LogicBlockLUTInputActivationLogicBlock0Input0
LogicBlockLUTInputActivationLogicBlock0Input1
LogicBlockLUTInputActivationLogicBlock0Input2
LogicBlockLUTInputActivationLogicBlock0Input3
LogicBlockLUTInputActivationLogicBlock1Input0
LogicBlockLUTInputActivationLogicBlock1Input1
LogicBlockLUTInputActivationLogicBlock1Input2
LogicBlockLUTInputActivationLogicBlock1Input3
LogicBlockLUTInputSourceLogicBlock0Input0
LogicBlockLUTInputSourceLogicBlock0Input1
LogicBlockLUTInputSourceLogicBlock0Input2
LogicBlockLUTInputSourceLogicBlock0Input3
LogicBlockLUTInputSourceLogicBlock1Input0
LogicBlockLUTInputSourceLogicBlock1Input1
LogicBlockLUTInputSourceLogicBlock1Input2
LogicBlockLUTInputSourceLogicBlock1Input3
LogicBlockLUTOutputValueAllLogicBlock0Enable
LogicBlockLUTOutputValueAllLogicBlock0Value
LogicBlockLUTOutputValueAllLogicBlock1Enable
LogicBlockLUTOutputValueAllLogicBlock1Value
OffsetX
OffsetY
PixelFormat
ReverseX
ReverseY

### Enumeration Values

<b>RgbTransformLightSource</b>
<b>Saturation</b>
<b>SaturationEnable</b>
<b>SensorShutterMode</b>
<b>SerialPortBaudRateSerialPort0</b>
<b>SerialPortDataBitsSerialPort0</b>
<b>SerialPortParitySerialPort0</b>
<b>SerialPortSourceSerialPort0</b>
<b>SerialPortStopBitsSerialPort0</b>
<b>Sharpening</b>
<b>SharpeningAuto</b>
<b>SharpeningEnable</b>
<b>SharpeningThreshold</b>
<b>TestPatternPipelineStart</b>
<b>TestPatternSensor</b>
<b>TransferBlockCount</b>
<b>TransferControlMode</b>
<b>TransferOperationMode</b>
<b>TriggerActivationAcquisitionStart</b>
<b>TriggerActivationFrameBurstStart</b>
<b>TriggerActivationFrameStart</b>
<b>TriggerDelayAcquisitionStart</b>
<b>TriggerDelayFrameBurstStart</b>
<b>TriggerDelayFrameStart</b>
<b>TriggerModeAcquisitionStart</b>
<b>TriggerModeFrameBurstStart</b>
<b>TriggerModeFrameStart</b>

### Enumeration Values

TriggerOverlapAcquisitionStart
TriggerOverlapFrameBurstStart
TriggerOverlapFrameStart
TriggerSourceAcquisitionStart
TriggerSourceFrameBurstStart
TriggerSourceFrameStart
UserOutputValueAll
V3_3EnableLine0
V3_3EnableLine1
V3_3EnableLine2
V3_3EnableLine3
V3_3EnableLine4
V3_3EnableLine5
V3_3EnableLine6
Width

## 12.6.6 User Set Feature Enable

Whether or not the selected feature is saved to user sets.

Property	Value
<b>Name</b>	UserSetFeatureEnable
<b>Interface</b>	IBoolean
<b>Access</b>	RO
<b>Visibility</b>	Expert

# 13 Chunk Data Control

Chunk Data allows you the ability to send additional information with the image data. This can be helpful when debugging issues or looking at what settings have been applied to the acquired image.

Use [ChunkModeActive](#) to enable chunk data for images.

The following information is available as chunk data:

Image - enabled by default and cannot be disabled.

Image CRC - enabled by default and cannot be disabled.

FramelD

OffsetX

OffsetY

Width

Height

Exposure Time

Gain

Black Level

Pixel Format

ImageTimestamp

Sequencer Set Active

Use [ChunkSelector](#) to select a chunk then use [ChunkEnable](#) to enable or disable it. Image and ImageCRC cannot be disabled.

Once acquisition has started Chunk data can not be altered. To enable or disable chunks acquisition must be stopped.

## 13.1 Summary Table

Name	Interface	Access	Visibility	Description
<a href="#">Chunk Mode Active</a>	IBoolean	RW	Expert	Activates the inclusion of Chunk data in the payload of the image.
<a href="#">Chunk Selector</a>	IEnumeration	RW	Expert	Selects which chunk data to enable or disable.
<a href="#">Chunk Enable [Chunk Selector]</a>	IBoolean	RW	Expert	Enables the inclusion of the selected Chunk data in the payload of the image.
<a href="#">Chunk Image</a>	IInteger	RO	Expert	Returns the image payload.

Name	Interface	Access	Visibility	Description
<a href="#">Image CRC</a>	Integer	RO	Expert	Returns the CRC of the image payload.
<a href="#">Chunk Frame ID</a>	Integer	RO	Expert	Returns the image frame ID.
<a href="#">Chunk Offset X</a>	Integer	RO	Expert	Returns the Offset X of the image included in the payload.
<a href="#">Chunk Offset Y</a>	Integer	RO	Expert	Returns the Offset Y of the image included in the payload.
<a href="#">Chunk Width</a>	Integer	RO	Expert	Returns the width of the image included in the payload.
<a href="#">Chunk Height</a>	Integer	RO	Expert	Returns the height of the image included in the payload.
<a href="#">Chunk Pixel Format</a>	Enumeration		Expert	Format of the pixel provided by the camera
<a href="#">Chunk Exposure Time</a>	Float	RO	Expert	Returns the exposure time used to capture the image.
<a href="#">Chunk Gain Selector</a>	Enumeration		Expert	Selects which gain to retrieve
<a href="#">Chunk Gain [Chunk Gain Selector]</a>	Float	RO	Expert	Returns the gain used to capture the image.
<a href="#">Chunk Black Level Selector</a>	Enumeration		Expert	Selects which black level to retrieve
<a href="#">Chunk Black Level [Chunk Black Level Selector]</a>	Float	RO	Expert	Returns the black level used to capture the image.
<a href="#">Chunk Timestamp</a>	Integer	RO	Expert	Returns the Timestamp of the image.
<a href="#">Chunk Sequencer Set Active</a>	Integer	RO	Expert	Returns the index of the active set of the running sequencer included in the payload.
<a href="#">Chunk Serial Data Length</a>	Integer	RO	Expert	Returns the length of the received serial data that was included in the payload.
<a href="#">Chunk Serial Data</a>	StringReg		Expert	Returns the serial data that was received.
<a href="#">Chunk Serial Receive Overflow</a>	Boolean	RO	Expert	Returns the status of the chunk serial receive overflow.

## 13.2 Chunk Data Control Features

## 13.2.1 Chunk Mode Active

Activates the inclusion of Chunk data in the payload of the image.

Property	Value
<b>Name</b>	ChunkModeActive
<b>Interface</b>	IBoolean
<b>Access</b>	RW
<b>Visibility</b>	Expert

## 13.2.2 Chunk Selector

Selects which chunk data to enable or disable.

Property	Value
<b>Name</b>	ChunkSelector
<b>Interface</b>	IEnumeration
<b>Access</b>	RW
<b>Visibility</b>	Expert

### Enumeration Values

Image
CRC
FramelD
OffsetX
OffsetY
Width
Height
ExposureTime
Gain
BlackLevel
PixelFormat



### Enumeration Values

Timestamp
SequencerSetActive
SerialData

## 13.2.3 Chunk Enable

Enables the inclusion of the selected Chunk data in the payload of the image.

Property	Value
<b>Name</b>	ChunkEnable <a href="#">[Chunk Selector]</a>
<b>Interface</b>	IBoolean
<b>Access</b>	RW
<b>Visibility</b>	Expert

## 13.2.4 Chunk Image

Returns the image payload.

Property	Value
<b>Name</b>	ChunkImage
<b>Interface</b>	IInteger
<b>Access</b>	RO
<b>Unit</b>	
<b>Visibility</b>	Expert

## 13.2.5 Image CRC

Returns the CRC of the image payload.

Property	Value
<b>Name</b>	ChunkCRC
<b>Interface</b>	IInteger
<b>Access</b>	RO

Property Value

Unit	
Visibility	Expert

### 13.2.6 Chunk Frame ID

Returns the image frame ID.

Property Value

Name	ChunkFrameID
Interface	Integer
Access	RO
Unit	
Visibility	Expert

### 13.2.7 Chunk Offset X

Returns the Offset X of the image included in the payload.

Property Value

Name	ChunkOffsetX
Interface	Integer
Access	RO
Unit	
Visibility	Expert

### 13.2.8 Chunk Offset Y

Returns the Offset Y of the image included in the payload.

Property Value

Name	ChunkOffsetY
Interface	Integer
Access	RO

Property	Value
Unit	
Visibility	Expert

### 13.2.9 Chunk Width

Returns the width of the image included in the payload.

Property	Value
Name	ChunkWidth
Interface	Integer
Access	RO
Unit	
Visibility	Expert

### 13.2.10 Chunk Height

Returns the height of the image included in the payload.

Property	Value
Name	ChunkHeight
Interface	Integer
Access	RO
Unit	
Visibility	Expert

### 13.2.11 Chunk Pixel Format

Format of the pixel provided by the camera

Property	Value
Name	ChunkPixelFormat
Interface	Enumeration
Access	
Visibility	Expert

### Enumeration Values

Mono8
Mono12Packed
Mono16
RGB8Packed
YUV422Packed
BayerGR8
BayerRG8
BayerGB8
BayerBG8
YCbCr601_422_8_CbYCrY

## 13.2.12 Chunk Exposure Time

Returns the exposure time used to capture the image.

Property	Value
<b>Name</b>	ChunkExposureTime
<b>Interface</b>	IFloat
<b>Access</b>	RO
<b>Unit</b>	us
<b>Visibility</b>	Expert

## 13.2.13 Chunk Gain Selector

Selects which gain to retrieve

Property	Value
<b>Name</b>	ChunkGainSelector
<b>Interface</b>	IEnumeration
<b>Access</b>	
<b>Visibility</b>	Expert

### Enumeration Values

All
Red
Green
Blue

## 13.2.14 Chunk Gain

Returns the gain used to capture the image.

Property	Value
<b>Name</b>	ChunkGain <a href="#">[Chunk Gain Selector]</a>
<b>Interface</b>	IFloat
<b>Access</b>	RO
<b>Unit</b>	dB
<b>Visibility</b>	Expert

## 13.2.15 Chunk Black Level Selector

Selects which black level to retrieve

Property	Value
<b>Name</b>	ChunkBlackLevelSelector
<b>Interface</b>	IEnumeration
<b>Access</b>	
<b>Visibility</b>	Expert

### Enumeration Values

All
-----

## 13.2.16 Chunk Black Level

Returns the black level used to capture the image.

Property	Value
<b>Name</b>	ChunkBlackLevel <a href="#">[Chunk Black Level Selector]</a>
<b>Interface</b>	IFloat
<b>Access</b>	RO
<b>Unit</b>	%
<b>Visibility</b>	Expert

### 13.2.17 Chunk Timestamp

Returns the Timestamp of the image.

Property	Value
<b>Name</b>	ChunkTimestamp
<b>Interface</b>	IInteger
<b>Access</b>	RO
<b>Unit</b>	
<b>Visibility</b>	Expert

### 13.2.18 Chunk Sequencer Set Active

Returns the index of the active set of the running sequencer included in the payload.

Property	Value
<b>Name</b>	ChunkSequencerSetActive
<b>Interface</b>	IInteger
<b>Access</b>	RO
<b>Unit</b>	
<b>Visibility</b>	Expert

### 13.2.19 Chunk Serial Data Length

Returns the length of the received serial data that was included in the payload.

Property	Value
<b>Name</b>	ChunkSerialDataLength
<b>Interface</b>	IInteger
<b>Access</b>	RO
<b>Unit</b>	
<b>Visibility</b>	Expert

### 13.2.20 Chunk Serial Data

Returns the serial data that was received.

Property	Value
<b>Name</b>	ChunkSerialData
<b>Interface</b>	IStringReg
<b>Access</b>	
<b>Visibility</b>	Expert

### 13.2.21 Chunk Serial Receive Overflow

Returns the status of the chunk serial receive overflow.

Property	Value
<b>Name</b>	ChunkSerialReceiveOverflow
<b>Interface</b>	IBoolean
<b>Access</b>	RO
<b>Visibility</b>	Expert

# 14 LUT Control

Lookup Table (LUT) is a common image processing technique to map a pixel from one value to the other. The camera has an 11-bit input lookup table that produces 9-bit output. When a pixel value is larger than the 11-bit maximum (i.e., 2047), LUT treats it the same as the 2047. The LUT is available for all pixel formats.

- When outputting 8-bit pixel formats, the 9-bit LUT output is rounded down to the 8-bit value.
- When outputting 12-bit pixel formats, the 9-bit LUT output stays as the most significant 9 bits of the 12-bit value and the remaining 3 bits are all zeros.
- When outputting 16-bit pixel formats, the 9-bit LUT output stays as the most significant 9 bits of the 16-bit value and the remaining 7 bits are all zeros.

Therefore, LUT should be used cautiously for 12-bit or 16-bit pixel formats since some of the least significant bits are thrown away.

The factory default LUT is the linear mapping after the camera powers on ( $P' = P/4$ ).

To customize a LUT:

1. Use the [LUT Selector](#) to choose which LUT to control. LUT1 is the only lookup table to allow user access and control.
2. Use [LUT Enable](#) to disable the selected LUT before customizing it. Customizations of the LUT apply immediately, therefore an active LUT that is changed may result in unexpected images.
3. Use [LUT Index](#) to identify the index (offset) of the coefficient to access.
4. [LUT Value](#) returns the value at the entry of the LUT Index. Enter the new value.
5. Repeat steps 3 and 4 as necessary.
6. Enable LUT to have changes take effect.

For coding purposes, [LUT Value All](#) provides access to all the LUT coefficients in a single string without using an individual LUT Index.

Since only one LUT is available for users to access and control, in RGB and YUV pixel formats, the same LUT applies to all three channels (i.e., red, green and blue). In monochrome and Bayer formats, there is a single channel, regardless of the color or monochrome image sensor.

Note that the customized LUT is not saved into the camera permanently. After power cycling, the LUT returns to the factory default.

## 14.1 Summary Table

Name	Interface	Access	Visibility	Description
<a href="#">LUT Selector</a>	IEnumeration		Expert	Selects which LUT to control.



Name	Interface	Access	Visibility	Description
<a href="#">LUT Enable [LUT Selector]</a>	IBoolean		Expert	Activates the selected LUT.
<a href="#">LUT Index [LUT Selector]</a>	IInteger		Guru	Control the index (offset) of the coefficient to access in the selected LUT.
<a href="#">LUT Value [LUT Selector] [LUT Index]</a>	IInteger		Guru	Returns the Value at entry LUTIndex of the LUT selected by LUTSelector.
<a href="#">LUT Value All [LUT Selector]</a>	IRegister		Guru	Accesses all the LUT coefficients in a single access without using individual LUTIndex.

## 14.2 LUT Control Features

### 14.2.1 LUT Selector

Selects which LUT to control.

Property	Value
<b>Name</b>	LUTSelector
<b>Interface</b>	IEnumeration
<b>Access</b>	
<b>Visibility</b>	Expert

#### Enumeration Values

LUT1

### 14.2.2 LUT Enable

Activates the selected LUT.

Property	Value
<b>Name</b>	LUTEnable <a href="#">[LUT Selector]</a>
<b>Interface</b>	IBoolean
<b>Access</b>	
<b>Visibility</b>	Expert

### 14.2.3 LUT Index

Control the index (offset) of the coefficient to access in the selected LUT.

Property	Value
Name	LUTIndex <a href="#">[LUT Selector]</a>
Interface	IInteger
Access	
Unit	
Visibility	Guru

### 14.2.4 LUT Value

Returns the Value at entry LUTIndex of the LUT selected by LUTSelector.

Property	Value
Name	LUTValue <a href="#">[LUT Selector]</a> <a href="#">[LUT Index]</a>
Interface	IInteger
Access	
Unit	
Visibility	Guru

### 14.2.5 LUT Value All

Accesses all the LUT coefficients in a single access without using individual LUTIndex.

Property	Value
Name	LUTValueAll <a href="#">[LUT Selector]</a>
Interface	IRegister
Access	
Visibility	Guru

# 15 Event Control

## 15.0.1 Event Features

Events allow you to get notified when the camera has performed something you might find interesting. Events are similar to the asynchronous communication but the difference is the initiator is the device.

Once an event is turned on, it has its own XML area where it outputs the event's ID, timestamp, and any applicable event data.

Use [EventSelector](#) to choose an event, then use [EventNotification](#) to set the event On or Off.

The possible events to choose are:

**Exposure End** - Event is sent every image when exposure end occurs. Event data includes: the event ID, timestamp, and frame ID.

**Error** - Event is sent every time an error occurs internally in the device. Event data includes: the event ID, timestamp, frame ID, and error code.

In order to verify that events are working, there is a [TriggerEventTest](#) command which allows you to trigger the camera to send a test event out.

**Event Test** - Event you can trigger to verify events are working properly. This is always enabled. Event data includes: exposure end ID and exposure end timestamp.

## 15.1 Summary Table

Name	Interface	Access	Visibility	Description
<a href="#">Event Selector</a>	IEnumeration	RW	Expert	Selects which Event to enable or disable.
<a href="#">Event Notification [Event Selector]</a>	IEnumeration	RW	Expert	Enables/Disables the selected event.
<a href="#">Event Exposure End Data</a>	ICategory	RO	Expert	Category that contains all the data features related to the Exposure End Event.
<a href="#">Event Error Data</a>	ICategory	RO	Expert	Category that contains all the data features related to the Error Event.
<a href="#">Event Serial Port Receive Data</a>	ICategory	RO	Expert	Category that contains all the data features related to the Serial Port Receive Event.
<a href="#">Event Test Data</a>	ICategory	RO	Expert	Category that contains all the data features related to the Test Event.

## 15.2 Event Control Features

### 15.2.1 Event Selector

Selects which Event to enable or disable.

Property	Value
<b>Name</b>	EventSelector
<b>Interface</b>	IEnumeration
<b>Access</b>	RW
<b>Visibility</b>	Expert

#### Enumeration Values

Error
ExposureEnd
SerialPortReceive

### 15.2.2 Event Notification

Enables/Disables the selected event.

Property	Value
<b>Name</b>	EventNotification <a href="#">[Event Selector]</a>
<b>Interface</b>	IEnumeration
<b>Access</b>	RW
<b>Visibility</b>	Expert

#### Enumeration Values

On
Off

### 15.2.3 Event Exposure End Data

Category that contains all the data features related to the Exposure End Event.

Property	Value
<b>Name</b>	EventExposureEndData

Property	Value
Interface	ICategory
Access	RO
Visibility	Expert

### 15.2.4 Event Error Data

Category that contains all the data features related to the Error Event.

Property	Value
Name	EventErrorData
Interface	ICategory
Access	RO
Visibility	Expert

### 15.2.5 Event Serial Port Receive Data

Category that contains all the data features related to the Serial Port Receive Event.

Property	Value
Name	EventSerialPortReceiveData
Interface	ICategory
Access	RO
Visibility	Expert

### 15.2.6 Event Test Data

Category that contains all the data features related to the Test Event.

Property	Value
Name	EventTestData
Interface	ICategory
Access	RO
Visibility	Expert

## 15.3 Event Exposure End Data

Category that contains all the data features related to the Exposure End Event.

### 15.3.1 Summary Table

Name	Interface	Access	Visibility	Description
<a href="#">Event Exposure End</a>	Integer	RO	Expert	Returns the unique identifier of the Exposure End type of Event.
<a href="#">Event Exposure End Timestamp</a>	Integer	RO	Expert	Returns the Timestamp of the Exposure End Event.
<a href="#">Event Exposure End Frame ID</a>	Integer	RO	Expert	Returns the unique Identifier of the Frame (or image) that generated the Exposure End Event.

### 15.3.2 Event Exposure End Data Features

#### 15.3.2.1 Event Exposure End

Returns the unique identifier of the Exposure End type of Event.

Property	Value
<b>Name</b>	EventExposureEnd
<b>Interface</b>	Integer
<b>Access</b>	RO
<b>Unit</b>	
<b>Visibility</b>	Expert
<b>Value</b>	0x9C43

#### 15.3.2.2 Event Exposure End Timestamp

Returns the Timestamp of the Exposure End Event.

Property	Value
<b>Name</b>	EventExposureEndTimestamp
<b>Interface</b>	Integer
<b>Access</b>	RO
<b>Unit</b>	

**Property Value**

**Visibility** Expert

### 15.3.2.3 Event Exposure End Frame ID

Returns the unique Identifier of the Frame (or image) that generated the Exposure End Event.

**Property Value**

<b>Name</b>	EventExposureEndFrameID
<b>Interface</b>	Integer
<b>Access</b>	RO
<b>Unit</b>	
<b>Visibility</b>	Expert

## 15.4 Event Error Data

Category that contains all the data features related to the Error Event.

### 15.4.1 Summary Table

Name	Interface	Access	Visibility	Description
<a href="#">Event Error</a>	Integer	RO	Expert	Returns the unique identifier of the Error type of Event.
<a href="#">Event Error Timestamp</a>	Integer	RO	Expert	Returns the Timestamp of the Error Event.
<a href="#">Event Error Frame ID</a>	Integer	RO	Expert	Returns the unique Identifier of the Frame (or image) that generated the Error Event.
<a href="#">Event Error Code</a>	Integer	RO	Expert	Returns the error code for the error that happened

### 15.4.2 Event Error Data Features

#### 15.4.2.1 Event Error

Returns the unique identifier of the Error type of Event.

**Property Value**

<b>Name</b>	EventError
<b>Interface</b>	Integer
<b>Access</b>	RO
<b>Unit</b>	
<b>Visibility</b>	Expert
<b>Value</b>	0x9C40

### 15.4.2.2 Event Error Timestamp

Returns the Timestamp of the Error Event.

**Property Value**

<b>Name</b>	EventErrorTimestamp
<b>Interface</b>	Integer
<b>Access</b>	RO
<b>Unit</b>	
<b>Visibility</b>	Expert

### 15.4.2.3 Event Error Frame ID

Returns the unique Identifier of the Frame (or image) that generated the Error Event.

**Property Value**

<b>Name</b>	EventErrorFrameID
<b>Interface</b>	Integer
<b>Access</b>	RO
<b>Unit</b>	
<b>Visibility</b>	Expert

### 15.4.2.4 Event Error Code

Returns the error code for the error that happened



Property	Value
<b>Name</b>	EventErrorCode
<b>Interface</b>	Integer
<b>Access</b>	RO
<b>Unit</b>	
<b>Visibility</b>	Expert

## 15.5 Event Serial Port Receive Data

Category that contains all the data features related to the Serial Port Receive Event.

### 15.5.1 Summary Table

Name	Interface	Access	Visibility	Description
<a href="#">Event Serial Port Receive</a>	Integer	RO	Expert	Returns the unique identifier of the Serial Port Receive type of Event.
<a href="#">Event Serial Port Receive Timestamp</a>	Integer	RO	Expert	Returns the Timestamp of the Serial Port Receive Event.
<a href="#">Event Serial Data</a>	IStringReg		Expert	Returns the serial data that was received.
<a href="#">Event Serial Data Length</a>	Integer	RO	Expert	Returns the length of the received serial data that was included in the event payload.
<a href="#">Event Serial Receive Overflow</a>	Boolean	RO	Expert	Returns the status of the event serial receive overflow.

### 15.5.2 Event Serial Port Receive Data Features

#### 15.5.2.1 Event Serial Port Receive

Returns the unique identifier of the Serial Port Receive type of Event.

Property	Value
<b>Name</b>	EventSerialPortReceive
<b>Interface</b>	Integer
<b>Access</b>	RO
<b>Unit</b>	

Property	Value
Visibility	Expert
Value	0x9C45

### 15.5.2.2 Event Serial Port Receive Timestamp

Returns the Timestamp of the Serial Port Receive Event.

Property	Value
Name	EventSerialPortReceiveTimestamp
Interface	IInteger
Access	RO
Unit	
Visibility	Expert

### 15.5.2.3 Event Serial Data

Returns the serial data that was received.

Property	Value
Name	EventSerialData
Interface	IStringReg
Access	
Visibility	Expert

### 15.5.2.4 Event Serial Data Length

Returns the length of the received serial data that was included in the event payload.

Property	Value
Name	EventSerialDataLength
Interface	IInteger
Access	RO
Unit	
Visibility	Expert

### 15.5.2.5 Event Serial Receive Overflow

Returns the status of the event serial receive overflow.

Property	Value
<b>Name</b>	EventSerialReceiveOverflow
<b>Interface</b>	IBoolean
<b>Access</b>	RO
<b>Visibility</b>	Expert

## 15.6 Event Test Data

Category that contains all the data features related to the Test Event.

### 15.6.1 Summary Table

Name	Interface	Access	Visibility	Description
<a href="#">Event Test</a>	IInteger	RO	Expert	Returns the unique identifier of the Test type of Event.
<a href="#">Event Test Timestamp</a>	IInteger	RO	Expert	Returns the Timestamp of the Test Event.

### 15.6.2 Event Test Data Features

#### 15.6.2.1 Event Test

Returns the unique identifier of the Test type of Event.

Property	Value
<b>Name</b>	EventTest
<b>Interface</b>	IInteger
<b>Access</b>	RO
<b>Unit</b>	
<b>Visibility</b>	Expert
<b>Value</b>	0x4FFF

### 15.6.2.2 Event Test Timestamp

Returns the Timestamp of the Test Event.

Property	Value
<b>Name</b>	EventTestTimestamp
<b>Interface</b>	Integer
<b>Access</b>	RO
<b>Unit</b>	
<b>Visibility</b>	Expert

# 16 Counter And Timer Control

The Counter and Timer control feature allows you to:

- Create a function generator

- Keep a count of how many times a signal has fired.

Use the CounterSelector to select a counter, either 0 or 1.

Use CounterEventSource to select the event to increment the counter. Possible counter event sources include:

- MHz Tick
- Line Inputs
- User Outputs
- Counter Starts
- Counter Ends
- Logic Block Outputs
- Exposure Start
- Exposure End
- Frame Trigger Wait

When the selected source allows for signal activation, use CounterEventActivation to specify Level Low, Level High, Falling Edge, Rising Edge, or Any Edge.

Use CounterDelay to indicate the maximum number of counts that need to occur before generating the Counter Start event.

Use CounterDuration to indicate the maximum number of counts that need to occur before generating the Counter End event.

**Note:** Only one of CounterTriggerSource or CounterResetSource can be active at a time. Selecting one disables the other.

Use CounterTriggerSource to select the event to start the counter. Possible counter trigger sources include:

- MHz Tick
- Line Inputs
- User Outputs
- Counter Starts
- Counter Ends
- Logic Block Outputs

- Exposure Start
- Exposure End
- Frame Trigger Wait

When the selected source allows for signal activation, use `CounterTriggerActivation` to specify Level Low, Level High, Falling Edge, Rising Edge, or Any Edge.

Use `CounterResetSource` to select the event to end the counter. Possible counter reset sources include:

- MHz Tick
- Line Inputs
- User Outputs
- Counter Starts
- Counter Ends
- Logic Block Outputs
- Exposure Start
- Exposure End
- Frame Trigger Wait

When the selected source allows for signal activation, use `CounterResetActivation` to specify Level Low, Level High, Falling Edge, Rising Edge, or Any Edge.

`CounterValue` indicates the current counter while `CounterStatus` indicates the current status. `CounterValueAtReset` indicates the counter's value when a reset occurred.

## 16.1 Summary Table

Name	Interface	Access	Visibility	Description
<a href="#">Counter Selector</a>	IEnumeration		Expert	Selects which counter to configure
<a href="#">Counter Event Source [Counter Selector]</a>	IEnumeration	RW	Expert	Selects the event that will increment the counter
<a href="#">Counter Event Activation [Counter Selector]</a>	IEnumeration	RW	Expert	Selects the activation mode of the event to increment the Counter.
<a href="#">Counter Duration [Counter Selector]</a>	Integer		Expert	Sets the duration (or number of events) before the CounterEnd event is generated.
<a href="#">Counter Value [Counter Selector]</a>	Integer	RO	Expert	Current counter value

Name	Interface	Access	Visibility	Description
<a href="#">Counter Value At Reset [Counter Selector]</a>	Integer	RW	Expert	Value of the selected Counter when it was reset by a trigger.
<a href="#">Counter Trigger Source [Counter Selector]</a>	IEnumeration	RW	Expert	Selects the source of the trigger to start the counter
<a href="#">Counter Trigger Activation [Counter Selector]</a>	IEnumeration	RW	Expert	Selects the activation mode of the trigger to start the Counter.
<a href="#">Counter Reset Source [Counter Selector]</a>	IEnumeration	RW	Expert	Selects the signal that will be the source to reset the Counter.
<a href="#">Counter Reset Activation [Counter Selector]</a>	IEnumeration	RW	Expert	Selects the Activation mode of the Counter Reset Source signal.
<a href="#">Counter Status [Counter Selector]</a>	IEnumeration	RO	Expert	Returns the current status of the Counter.
<a href="#">Counter Delay [Counter Selector]</a>	Integer		Expert	Sets the delay (or number of events) before the CounterStart event is generated.

## 16.2 Counter And Timer Control Features

### 16.2.1 Counter Selector

Selects which counter to configure

Property	Value
<b>Name</b>	CounterSelector
<b>Interface</b>	IEnumeration
<b>Access</b>	
<b>Visibility</b>	Expert

#### Enumeration Values

Counter0
Counter1

## 16.2.2 Counter Event Source

Selects the event that will increment the counter

Property	Value
<b>Name</b>	CounterEventSource <a href="#">[Counter Selector]</a>
<b>Interface</b>	IEnumeration
<b>Access</b>	RW
<b>Visibility</b>	Expert

### Enumeration Values

Off
MHzTick
Line0
Line1
Line2
Line3
Line4
Line5
Line6
UserOutput0
UserOutput1
UserOutput2
UserOutput3
Counter0Start
Counter1Start
Counter0End
Counter1End
LogicBlock0
LogicBlock1



### Enumeration Values

ExposureStart

ExposureEnd

FrameTriggerWait

## 16.2.3 Counter Event Activation

Selects the activation mode of the event to increment the Counter.

Property	Value
<b>Name</b>	CounterEventActivation <a href="#">[Counter Selector]</a>
<b>Interface</b>	IEnumeration
<b>Access</b>	RW
<b>Visibility</b>	Expert

### Enumeration Values

LevelLow

LevelHigh

FallingEdge

RisingEdge

AnyEdge

## 16.2.4 Counter Duration

Sets the duration (or number of events) before the CounterEnd event is generated.

Property	Value
<b>Name</b>	CounterDuration <a href="#">[Counter Selector]</a>
<b>Interface</b>	IInteger
<b>Access</b>	
<b>Unit</b>	
<b>Visibility</b>	Expert

## 16.2.5 Counter Value

Current counter value

Property	Value
Name	CounterValue <a href="#">[Counter Selector]</a>
Interface	Integer
Access	RO
Unit	
Visibility	Expert

## 16.2.6 Counter Value At Reset

Value of the selected Counter when it was reset by a trigger.

Property	Value
Name	CounterValueAtReset <a href="#">[Counter Selector]</a>
Interface	Integer
Access	RW
Unit	
Visibility	Expert

## 16.2.7 Counter Trigger Source

Selects the source of the trigger to start the counter

Property	Value
Name	CounterTriggerSource <a href="#">[Counter Selector]</a>
Interface	IEnumeration
Access	RW
Visibility	Expert

### Enumeration Values

Off

**Enumeration Values**

Line0
Line1
Line2
Line3
Line4
Line5
Line6
UserOutput0
UserOutput1
UserOutput2
UserOutput3
Counter0Start
Counter1Start
Counter0End
Counter1End
LogicBlock0
LogicBlock1
ExposureStart
ExposureEnd
FrameTriggerWait

## 16.2.8 Counter Trigger Activation

Selects the activation mode of the trigger to start the Counter.

Property	Value
<b>Name</b>	CounterTriggerActivation <a href="#">[Counter Selector]</a>
<b>Interface</b>	IEnumeration
<b>Access</b>	RW
<b>Visibility</b>	Expert

**Enumeration Values**

LevelLow

LevelHigh

FallingEdge

RisingEdge

AnyEdge

## 16.2.9 Counter Reset Source

Selects the signal that will be the source to reset the Counter.

Property	Value
<b>Name</b>	CounterResetSource <a href="#">[Counter Selector]</a>
<b>Interface</b>	IEnumeration
<b>Access</b>	RW
<b>Visibility</b>	Expert

**Enumeration Values**

Off

Line0

Line1

Line2

Line3

Line4

Line5

Line6

UserOutput0

UserOutput1

UserOutput2

UserOutput3

**Enumeration Values**

Counter0Start

Counter1Start

Counter0End

Counter1End

LogicBlock0

LogicBlock1

ExposureStart

ExposureEnd

FrameTriggerWait

## 16.2.10 Counter Reset Activation

Selects the Activation mode of the Counter Reset Source signal.

Property	Value
<b>Name</b>	CounterResetActivation <a href="#">[Counter Selector]</a>
<b>Interface</b>	IEnumeration
<b>Access</b>	RW
<b>Visibility</b>	Expert

**Enumeration Values**

LevelLow

LevelHigh

FallingEdge

RisingEdge

AnyEdge

## 16.2.11 Counter Status

Returns the current status of the Counter.

Property	Value
<b>Name</b>	CounterStatus <a href="#">[Counter Selector]</a>
<b>Interface</b>	IEnumeration
<b>Access</b>	RO
<b>Visibility</b>	Expert

#### Enumeration Values

CounterIdle
CounterTriggerWait
CounterActive
CounterCompleted
CounterOverflow

### 16.2.12 Counter Delay

Sets the delay (or number of events) before the CounterStart event is generated.

Property	Value
<b>Name</b>	CounterDelay <a href="#">[Counter Selector]</a>
<b>Interface</b>	IInteger
<b>Access</b>	
<b>Unit</b>	
<b>Visibility</b>	Expert

# 17 Test Control

Test Control provides functionality to allow certain features to be exercised.

There are two features available in Test Control:

**TestEventGenerate** - This feature allows you to generate test events. Executing sends a single TestEvent, which then populates the Event Test Data selector with the ID and the timestamp of when the event occurred.

**TestPendingAck** - This feature allows you to test the device's pending acknowledge feature. When this feature is written, the device waits for the corresponding time period in milliseconds before acknowledging the write.

**Test0001** - This feature is for internal testing only.

If a test fails, an error is produced for the log.

## 17.1 Summary Table

Name	Interface	Access	Visibility	Description
<a href="#">Test Event Generate</a>	ICommand	WO	Guru	This command generates a test event and sends it to the host.
<a href="#">Test 0001</a>	Integer	RW	Expert	For testing only.

## 17.2 Test Control Features

### 17.2.1 Test Event Generate

This command generates a test event and sends it to the host.

Property	Value
<b>Name</b>	TestEventGenerate
<b>Interface</b>	ICommand
<b>Access</b>	WO
<b>Visibility</b>	Guru

### 17.2.2 Test 0001

For testing only.

Property	Value
Name	Test0001
Interface	Integer
Access	RW
Unit	
Visibility	Expert



# 18 Logic Block Control

For more detail, see [TAN2016005 Using Logic Blocks](#)

A Logic Block is a collection of combinatorial logic and latches that allows the user to create new, custom signals inside the camera. Each Logic Block is comprised of 2 lookup tables (LUT) with programmable inputs, truth tables and a flip flop output. There is a LUT for both the D input (Value LUT) and the enable input (Enable LUT) of the flip flop. Both LUTs have 3 inputs and thus have 8 configuration bits for their truth table.

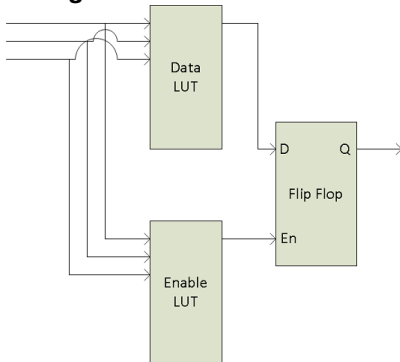

To configure the LUTs first select either the Value or Enable LUT using the `LogicBlockLUTSelector`, then use the `LogicBlockLUTInput` to configure the different inputs into the LUT - note that the Value and Enable LUT share the inputs so setting the inputs on one will affect the other. The `LogicBlockLUTInputSource` selects the internal signal to be used and the `LogicBlockLUTInputActivation` selects what level or edge to be considered a positive input into the LUT. Once the inputs to the LUT have been selected the entries in the truth table can be configure either individually using the `LogicBlockLUTRowIndex` and `LogicBlockLUTOutput` or all at once using the `LogicBlockLUTOutputValueAll`

The following truth table show a simple AND of Input1 and Input2 while Input0 is not considered ("DON'T CARE").

Source			Output
2	1	0	
0	0	0	0
0	0	1	0
0	1	0	0
0	1	1	0
1	0	0	0
1	0	1	0
1	1	0	1
1	1	1	1

To program this function into a LUT write the value of 0xC0 (1100 0000b) to the LogicBlockLUTOutputValueAll.

The details of the output Flip Flop output are shown in the following table. The previous value of the Value LUT will remain on the output until the Enable LUT is set at which point the output will be updated to the new value of the Value LUT. This allows latching of a given signal. To effectively bypass the output latch and pass the Value LUT signal through continuously simple program the Enable LUT truth table to all 1's (LogicBlockLUTOutputValueAll = 0xFF)

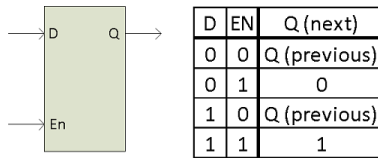

## 18.1 Summary Table

Name	Interface	Access	Visibility	Description
<a href="#">Logic Block Selector</a>	IEnumeration		Guru	Selects which LogicBlock to configure
<a href="#">Logic Block LUT Selector [Logic Block Selector]</a>	IEnumeration		Guru	Selects which LogicBlock LUT to configure
<a href="#">Logic Block LUT Input Selector [Logic Block LUT Selector]</a>	IEnumeration		Guru	Controls which LogicBlockLUT Input Source & Activation to access.
<a href="#">Logic Block LUT Input Source [Logic Block LUT Input Selector]</a>	IEnumeration	RW	Guru	Selects the source for the input into the Logic LUT.
<a href="#">Logic Block LUT Input Activation [Logic Block LUT Input Selector]</a>	IEnumeration		Guru	Selects the activation mode of the Logic Input Source signal.
<a href="#">Logic Block LUT Output Value All [Logic Block LUT Selector]</a>	IInteger		Guru	Sets the value of all the output bits in the selected LUT.
<a href="#">Logic Block LUT Row Index [Logic Block LUT Selector]</a>	IInteger		Guru	Controls the row of the truth table to access in the selected LUT.
<a href="#">Logic Block LUT Output Value [Logic Block LUT Row Index]</a>	IBoolean		Guru	Controls the output column of the truth table for the selected LogicBlockLUTRowIndex.

## 18.2 Logic Block Control Features

## 18.2.1 Logic Block Selector

Selects which LogicBlock to configure

Property	Value
<b>Name</b>	LogicBlockSelector
<b>Interface</b>	IEnumeration
<b>Access</b>	
<b>Visibility</b>	Guru

### Enumeration Values

LogicBlock0

LogicBlock1

## 18.2.2 Logic Block LUT Selector

Selects which LogicBlock LUT to configure

Property	Value
<b>Name</b>	LogicBlockLUTSelector <a href="#">[Logic Block Selector]</a>
<b>Interface</b>	IEnumeration
<b>Access</b>	
<b>Visibility</b>	Guru

### Enumeration Values

Value

Enable

## 18.2.3 Logic Block LUT Input Selector

Controls which LogicBlockLUT Input Source & Activation to access.

Property	Value
<b>Name</b>	LogicBlockLUTInputSelector <a href="#">[Logic Block LUT Selector]</a>
<b>Interface</b>	IEnumeration

Property	Value
Access	
Visibility	Guru

#### Enumeration Values

Input0
Input1
Input2
Input3

### 18.2.4 Logic Block LUT Input Source

Selects the source for the input into the Logic LUT.

Property	Value
Name	LogicBlockLUTInputSource <a href="#">[Logic Block LUT Input Selector]</a>
Interface	IEnumeration
Access	RW
Visibility	Guru

#### Enumeration Values

Zero
Line0
Line1
Line2
Line3
Line4
Line5
Line6
UserOutput0

**Enumeration Values**

UserOutput1
UserOutput2
UserOutput3
Counter0Start
Counter1Start
Counter0End
Counter1End
LogicBlock0
LogicBlock1
ExposureStart
ExposureEnd
FrameTriggerWait
AcquisitionActive

## 18.2.5 Logic Block LUT Input Activation

Selects the activation mode of the Logic Input Source signal.

Property	Value
<b>Name</b>	LogicBlockLUTInputActivation <a href="#">[Logic Block LUT Input Selector]</a>
<b>Interface</b>	IEnumeration
<b>Access</b>	
<b>Visibility</b>	Guru

**Enumeration Values**

LevelLow
LevelHigh
FallingEdge
RisingEdge
AnyEdge

## 18.2.6 Logic Block LUT Output Value All

Sets the value of all the output bits in the selected LUT.

Property	Value
<b>Name</b>	LogicBlockLUTOutputValueAll <a href="#">[Logic Block LUT Selector]</a>
<b>Interface</b>	IInteger
<b>Access</b>	
<b>Unit</b>	
<b>Visibility</b>	Guru

## 18.2.7 Logic Block LUT Row Index

Controls the row of the truth table to access in the selected LUT.

Property	Value
<b>Name</b>	LogicBlockLUTRowIndex <a href="#">[Logic Block LUT Selector]</a>
<b>Interface</b>	IInteger
<b>Access</b>	
<b>Unit</b>	
<b>Visibility</b>	Guru

## 18.2.8 Logic Block LUT Output Value

Controls the output column of the truth table for the selected LogicBlockLUTRowIndex.

Property	Value
<b>Name</b>	LogicBlockLUTOutputValue <a href="#">[Logic Block LUT Row Index]</a>
<b>Interface</b>	IBoolean
<b>Access</b>	
<b>Visibility</b>	Guru

# 19 Digital IO Control

The camera has an 12-pin GPIO connector on the back of the case; refer to the diagram below for wire color-coding.

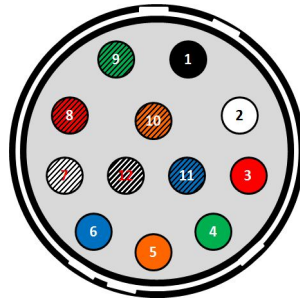

Color	Pin	Line	Function	Description
Black	1	N/A	GND	DC camera power ground
White	2	N/A	POWER	DC camera power
Red	3	Line 1	GPIO_OPT_OUT1	Opto-isolated output (GPO1)
Green	4	Line 4	GPIO_OPT_OUT2	Opto-isolated output (GPO2)
Orange	5	Line 0	GPIO_OPT_IN1	Opto-isolated input (GPI1)
Blue	6	Line 3	GPIO_OPT_IN2	Opto-isolated input (GPI2)
White with black stripes	7	Line 2	GPIO_TTL_IO3	TTL input/output 3
Red with black stripes	8	Line 5	GPIO_TTL_IO4	TTL input/output 4
Green with black stripes	9	N/A	GND	DC camera power ground
Orange with black stripes	10	N/A	POWER	DC camera power
Blue with black stripes	11	Line 6	3.3 V OUTPUT	+3.3 V output, current 120 mA (nominal) - firmware enabled
Black with black stripes	12	N/A	OPTO_GND	Ground for opto-isolated I/O, not connected

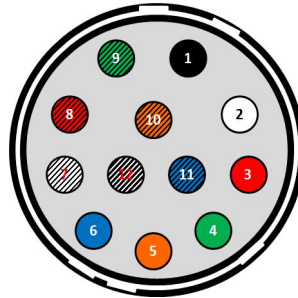

Color	Pin	Line	Function	Description
white stripes				to camera ground

This section describes how to configure the camera's general purpose digital input and outputs (sometimes referred to as GPIO).

Use [LineSelector](#) to choose which of the 4 lines to configure. All the features listed beneath it are controllable on a per line basis.

Use [Line Mode](#) to control the direction - either Input or Output - of the selected I/O line.

Use [3.3V Enable](#) to supply external circuits with power. This is different than standard logic outputs in that it is comparatively slow to switch but can supply a more significant amount of power. This is only available on some pins.

Use [LineInverter](#) to control a logic inverter on the selected line.

[LineStatus](#) indicates the current status of the selected line. A checked status (enabled) indicates logic high. An unchecked status (disabled) indicates logic low. Since this node must be polled to get its status it should not be used as a real time control for reading internal signals.

[LineStatusAll](#) is a hexadecimal representation of all the line status bits (Line 0 status corresponds to bit 0, Line 1 status with bit 1, etc). This allows simultaneous reading of all line statuses at once.

Use the [LineInputFilterSelector](#) to choose a filter. Filters are unique per line. Use [LineFilterWidth](#) to set the width of the filter in microseconds. There are two choices of filter:

**Degitch** - designed to filter out any noise or other spurious signals on the line, it does not consider the state to have transitioned until after the Filter Width time has expired. This means that Deglitch introduces a delay in the signal.

**Debounce** - designed to filter out rapid connecting and disconnecting common in mechanical switches. This means that Debounce considers the first edge as valid and won't allow a subsequent change of state until after the debounce time has elapsed.

**Note:** The Deglitch filter is applied before Debounce filter.

Use [LineSource](#) to control what signal is output on the line when the Line Mode is set to output. The choices are:

**Other Lines** - creates a loop back

**User Outputs** - outputs user controllable internal signals

**Counter Active** - shows when a counter is in use

**Logic Blocks** - drives the lines



**Exposure Active** - indicates when the image sensor is exposing

**Frame Trigger Wait** - indicates when the camera is ready to accept a new Frame Start trigger

If a User Output is selected as a Line Source, use [UserOutputSelector](#) to select which bit to use as internal signals within the camera. Use [UserOutputValue](#) to set the selected user output to logic high (enabled) or logic low (disabled).

[UserOutputValueAll](#) is a hexadecimal representation of all the user output bits (User Output 0 corresponds to bit 0, User Output 1 with bit 1, etc). Reading or writing User Output Value All allows simultaneous setting or reading of all user outputs at once.

[LineFormat](#) is read only and indicates what type of circuit the selected line has. The options for Line Format are:

**Tri State** - indicates the line is not driven. This is typical for digital inputs.

**Opto Coupled** - indicates that an opto isolator is being used to isolated the external circuitry from the internal camera electronics.

**Open Drain** - indicates there is an internal MOSFET that will pull the pin low but requires an external pull up resistor to produce a logic level high signal. This is typical for digital outputs.

## 19.1 Summary Table

Name	Interface	Access	Visibility	Description
<a href="#">Line Selector</a>	IEnumeration		Expert	Selects the physical line (or pin) of the external device connector to configure
<a href="#">Line Mode</a> <a href="#">[Line Selector]</a>	IEnumeration		Expert	Controls if the physical Line is used to Input or Output a signal.
<a href="#">3.3V Enable</a> <a href="#">[Line Selector]</a>	IBoolean	RW	Guru	Internally generated 3.3V rail. Enable to supply external circuits with power. This is different than standard logic outputs in that it is comparatively slow to switch but can supply a more significant amount of power. This is only available on some pins.
<a href="#">Line Inverter</a> <a href="#">[Line Selector]</a>	IBoolean	RW	Expert	Controls the inversion of the signal of the selected input or output line.
<a href="#">Line Status</a> <a href="#">[Line Selector]</a>	IBoolean	RO	Expert	Returns the current status of the selected input or output Line
<a href="#">Line Status All</a>	IInteger	RO	Expert	Returns the current status of all the line status bits in a hexadecimal representation (Line 0 status corresponds to bit 0, Line 1 status with bit 1, etc). This allows simultaneous reading of all line

Name	Interface	Access	Visibility	Description
				statuses at once.
<a href="#">Input filter Selector</a> <a href="#">[Line Selector]</a>	IEnumeration		Expert	Selects the kind of input filter to configure: Deglitch or Debounce.
<a href="#">Line Filter Width</a> <a href="#">[Input filter Selector]</a>	IFloat		Expert	Filter width in microseconds for the selected line and filter combination
<a href="#">Line Source</a> <a href="#">[Line Selector]</a>	IEnumeration		Expert	Selects which internal acquisition or I/O source signal to output on the selected line. LineMode must be Output.
<a href="#">Line Format</a> <a href="#">[Line Selector]</a>	IEnumeration	RO	Expert	Displays the current electrical format of the selected physical input or output Line.
<a href="#">Exposure Active Mode</a>	IEnumeration	RW	Expert	Control sensor active exposure mode.
<a href="#">User Output Selector</a>	IEnumeration		Expert	Selects which bit of the User Output register is set by UserOutputValue.
<a href="#">User Output Value</a> <a href="#">[User Output Selector]</a>	IBoolean	RW	Expert	Value of the selected user output, either logic high (enabled) or logic low (disabled).
<a href="#">User Output Value All</a>	IInteger		Expert	Returns the current status of all the user output status bits in a hexadecimal representation (UserOutput 0 status corresponds to bit 0, UserOutput 1 status with bit 1, etc). This allows simultaneous reading of all user output statuses at once.

## 19.2 Digital IO Control Features

## 19.2.1 Line Selector

Selects the physical line (or pin) of the external device connector to configure

Property	Value
<b>Name</b>	LineSelector
<b>Interface</b>	IEnumeration
<b>Access</b>	
<b>Visibility</b>	Expert

### Enumeration Values

Line0
Line1
Line2
Line3
Line4
Line5
Line6

## 19.2.2 Line Mode

Controls if the physical Line is used to Input or Output a signal.

Property	Value
<b>Name</b>	LineMode <a href="#">[Line Selector]</a>
<b>Interface</b>	IEnumeration
<b>Access</b>	
<b>Visibility</b>	Expert

### Enumeration Values

Input
Output

### 19.2.3 3.3V Enable

Internally generated 3.3V rail. Enable to supply external circuits with power. This is different than standard logic outputs in that it is comparatively slow to switch but can supply a more significant amount of power. This is only available on some pins.

Property	Value
Name	V3_3Enable <a href="#">[Line Selector]</a>
Interface	IBoolean
Access	RW
Visibility	Guru

### 19.2.4 Line Inverter

Controls the inversion of the signal of the selected input or output line.

Property	Value
Name	LineInverter <a href="#">[Line Selector]</a>
Interface	IBoolean
Access	RW
Visibility	Expert

### 19.2.5 Line Status

Returns the current status of the selected input or output Line

Property	Value
Name	LineStatus <a href="#">[Line Selector]</a>
Interface	IBoolean
Access	RO
Visibility	Expert

### 19.2.6 Line Status All

Returns the current status of all the line status bits in a hexadecimal representation (Line 0 status corresponds to bit 0, Line 1 status with bit 1, etc). This allows simultaneous reading of all line statuses at once.

Property	Value
<b>Name</b>	LineStatusAll
<b>Interface</b>	IInteger
<b>Access</b>	RO
<b>Unit</b>	
<b>Visibility</b>	Expert

## 19.2.7 Input filter Selector

Selects the kind of input filter to configure: Deglitch or Debounce.

Property	Value
<b>Name</b>	LineInputFilterSelector <a href="#">[Line Selector]</a>
<b>Interface</b>	IEnumeration
<b>Access</b>	
<b>Visibility</b>	Expert

### Enumeration Values

Deglitch

Debounce

## 19.2.8 Line Filter Width

Filter width in microseconds for the selected line and filter combination

Property	Value
<b>Name</b>	LineFilterWidth <a href="#">[Input filter Selector]</a>
<b>Interface</b>	IFloat
<b>Access</b>	
<b>Unit</b>	us
<b>Visibility</b>	Expert

## 19.2.9 Line Source

Selects which internal acquisition or I/O source signal to output on the selected line. LineMode must be Output.

Property	Value
<b>Name</b>	LineSource <a href="#">[Line Selector]</a>
<b>Interface</b>	IEnumeration
<b>Access</b>	
<b>Visibility</b>	Expert

### Enumeration Values

Off
Line0
Line1
Line2
Line3
Line4
Line5
Line6
UserOutput0
UserOutput1
UserOutput2
UserOutput3
Counter0Active
Counter1Active
LogicBlock0
LogicBlock1
ExposureActive
FrameTriggerWait
SerialPort0

## 19.2.10 Line Format

Displays the current electrical format of the selected physical input or output Line.

Property	Value
<b>Name</b>	LineFormat <a href="#">[Line Selector]</a>
<b>Interface</b>	IEnumeration
<b>Access</b>	RO
<b>Visibility</b>	Expert

### Enumeration Values

NoConnect
TTL
OptoCoupled

## 19.2.11 Exposure Active Mode

Control sensor active exposure mode.

Property	Value
<b>Name</b>	ExposureActiveMode
<b>Interface</b>	IEnumeration
<b>Access</b>	RW
<b>Visibility</b>	Expert

### Enumeration Values

Line1
AnyPixels
AllPixels

## 19.2.12 User Output Selector

Selects which bit of the User Output register is set by UserOutputValue.

Property	Value
<b>Name</b>	UserOutputSelector
<b>Interface</b>	IEnumeration
<b>Access</b>	
<b>Visibility</b>	Expert

#### Enumeration Values

UserOutput0
UserOutput1
UserOutput2
UserOutput3

### 19.2.13 User Output Value

Value of the selected user output, either logic high (enabled) or logic low (disabled).

Property	Value
<b>Name</b>	UserOutputValue <a href="#">[User Output Selector]</a>
<b>Interface</b>	IBoolean
<b>Access</b>	RW
<b>Visibility</b>	Expert

### 19.2.14 User Output Value All

Returns the current status of all the user output status bits in a hexadecimal representation (UserOutput 0 status corresponds to bit 0, UserOutput 1 status with bit 1, etc). This allows simultaneous reading of all user output statuses at once.

Property	Value
<b>Name</b>	UserOutputValueAll
<b>Interface</b>	IInteger
<b>Access</b>	
<b>Unit</b>	
<b>Visibility</b>	Expert





## 20 Serial Port Control

### 20.1 Serial Port

The serial port can be used to transmit and receive serial data through the device using the transport layer. The serial data can be sent through the transport layer in image data (via the SerialData Chunk Data), in control data (via the File Access Control), or in event data (via the SerialPortReceive Event).

The serial port to configure is selected using the [SerialPortSelector](#). The physical line on which to receive serial data is set using the [SerialPortSource](#). The physical line on which to transmit serial data is set using the LineSource in the Digital IO Control. The serial port settings for both the receive and transmit can be set using the [SerialPortBaudRate](#), [SerialPortDataBits](#), [SerialPortStopBits](#), and [SerialPortParity](#).

Serial data can be transmitted and received through the File Access Control. Once the serial port file is opened, data can be transmitted via Write operations and received via Read operations. Received serial data can also be obtained through the SerialPortReceive Event which will be generated when data is available or through the SerialData Chunk Data which is appended into each image payload.

The total number of characters in the serial port transmit and receive queues can be monitored using the [SerialTransmitQueueMaxCharacterCount](#) and the [SerialReceiveQueueMaxCharacterCount](#). The current number of characters in the queues can be monitored using the [SerialTransmitQueueCurrentCharacterCount](#) and [SerialReceiveQueueCurrentCharacterCount](#). The [SerialReceiveQueueCurrentCharacterCount](#) reports the maximum number of characters that can be obtained using the File Access Control. The receive queue can be emptied by executing the [SerialReceiveQueueClear](#).

Serial port framing and parity errors are reported using the [SerialRecieveFramingErrorCount](#) and the [SerialReceiveParityErrorCount](#). Overflow errors are reported within the SerialData Chunk Data, the SerialPortReceive Event, or in the FileOperationStatus after executing a Read.

### 20.2 Summary Table

Name	Interface	Access	Visibility	Description
<a href="#">Serial Port Selector</a>	IEnumeration	RW	Expert	Selects which serial port of the device to control.
<a href="#">Serial Port Source [Serial Port Selector]</a>	IEnumeration	RW	Expert	Specifies the physical input Line on which to receive serial data.
<a href="#">Serial Port Baud Rate [Serial Port Selector]</a>	IEnumeration	RW	Expert	This feature controls the baud rate used by the selected serial port.
<a href="#">Serial Port Data Bits [Serial Port Selector]</a>	Integer	RW	Expert	This feature controls the number of data bits used by the selected serial port. Possible values that can be used are

Name	Interface	Access	Visibility	Description
				between 5 and 9.
<a href="#">Serial Port Stop Bits [Serial Port Selector]</a>	IEnumeration	RW	Expert	This feature controls the number of stop bits used by the selected serial port.
<a href="#">Serial Port Parity [Serial Port Selector]</a>	IEnumeration	RW	Expert	This feature controls the parity used by the selected serial port.
<a href="#">Transmit Queue Max Character Count [Serial Port Selector]</a>	Integer	RO	Expert	>Returns the maximum number of characters in the serial port transmit queue.
<a href="#">Transmit Queue Current Character Count [Serial Port Selector]</a>	Integer	RO	Expert	Returns the number of characters currently in the serial port transmit queue.
<a href="#">Receive Queue Max Character Count [Serial Port Selector]</a>	Integer	RO	Expert	>Returns the maximum number of characters in the serial port receive queue.
<a href="#">Receive Queue Current Character Count [Serial Port Selector]</a>	Integer	RO	Expert	Returns the number of characters currently in the serial port receive queue.
<a href="#">Receive Queue Clear [Serial Port Selector]</a>	ICommand	WO	Expert	This is a command that clears the device serial port receive queue.
<a href="#">Receive Framing Error Count [Serial Port Selector]</a>	Integer	RO	Expert	Returns the number of framing errors that have occurred on the serial port.
<a href="#">Receive Parity Error Count [Serial Port Selector]</a>	Integer	RO	Expert	Returns the number of parity errors that have occurred on the serial port.

## 20.3 Serial Port Control Features

### 20.3.1 Serial Port Selector

Selects which serial port of the device to control.

Property	Value
<b>Name</b>	SerialPortSelector

Property	Value
Interface	IEnumeration
Access	RW
Visibility	Expert

#### Enumeration Values

SerialPort0

## 20.3.2 Serial Port Source

Specifies the physical input Line on which to receive serial data.

Property	Value
Name	SerialPortSource <a href="#">[Serial Port Selector]</a>
Interface	IEnumeration
Access	RW
Visibility	Expert

#### Enumeration Values

Line0

Line1

Line2

Line3

Line4

Line5

Line6

Off

## 20.3.3 Serial Port Baud Rate

This feature controls the baud rate used by the selected serial port.

Property	Value
<b>Name</b>	SerialPortBaudRate <a href="#">[Serial Port Selector]</a>
<b>Interface</b>	IEnumeration
<b>Access</b>	RW
<b>Visibility</b>	Expert

#### Enumeration Values

Baud300
Baud600
Baud1200
Baud2400
Baud4800
Baud9600
Baud14400
Baud19200
Baud38400
Baud57600
Baud115200
Baud230400
Baud460800
Baud921600

### 20.3.4 Serial Port Data Bits

This feature controls the number of data bits used by the selected serial port. Possible values that can be used are between 5 and 9.

Property	Value
<b>Name</b>	SerialPortDataBits <a href="#">[Serial Port Selector]</a>
<b>Interface</b>	Integer
<b>Access</b>	RW

Property	Value
Unit	
Visibility	Expert

### 20.3.5 Serial Port Stop Bits

This feature controls the number of stop bits used by the selected serial port.

Property	Value
Name	SerialPortStopBits <a href="#">[Serial Port Selector]</a>
Interface	IEnumeration
Access	RW
Visibility	Expert

#### Enumeration Values

Bits1
Bits1AndAHalf
Bits2

### 20.3.6 Serial Port Parity

This feature controls the parity used by the selected serial port.

Property	Value
Name	SerialPortParity <a href="#">[Serial Port Selector]</a>
Interface	IEnumeration
Access	RW
Visibility	Expert

#### Enumeration Values

None
Odd

### Enumeration Values

Even
Mark
Space

## 20.3.7 Transmit Queue Max Character Count

>Returns the maximum number of characters in the serial port transmit queue.

Property	Value
<b>Name</b>	SerialTransmitQueueMaxCharacterCount <a href="#">[Serial Port Selector]</a>
<b>Interface</b>	Integer
<b>Access</b>	RO
<b>Unit</b>	
<b>Visibility</b>	Expert

## 20.3.8 Transmit Queue Current Character Count

Returns the number of characters currently in the serial port transmit queue.

Property	Value
<b>Name</b>	SerialTransmitQueueCurrentCharacterCount <a href="#">[Serial Port Selector]</a>
<b>Interface</b>	Integer
<b>Access</b>	RO
<b>Unit</b>	
<b>Visibility</b>	Expert

## 20.3.9 Receive Queue Max Character Count

>Returns the maximum number of characters in the serial port receive queue.

Property	Value
<b>Name</b>	SerialReceiveQueueMaxCharacterCount <a href="#">[Serial Port Selector]</a>
<b>Interface</b>	Integer

Property	Value
----------	-------

Access	RO
Unit	
Visibility	Expert

### 20.3.10 Receive Queue Current Character Count

Returns the number of characters currently in the serial port receive queue.

Property	Value
----------	-------

Name	SerialReceiveQueueCurrentCharacterCount <a href="#">[Serial Port Selector]</a>
Interface	Integer
Access	RO
Unit	
Visibility	Expert

### 20.3.11 Receive Queue Clear

This is a command that clears the device serial port receive queue.

Property	Value
----------	-------

Name	SerialReceiveQueueClear <a href="#">[Serial Port Selector]</a>
Interface	Command
Access	WO
Visibility	Expert

### 20.3.12 Receive Framing Error Count

Returns the number of framing errors that have occurred on the serial port.

Property	Value
----------	-------

Name	SerialReceiveFramingErrorCount <a href="#">[Serial Port Selector]</a>
Interface	Integer
Access	RO



Property	Value
Unit	
Visibility	Expert

### 20.3.13 Receive Parity Error Count

Returns the number of parity errors that have occurred on the serial port.

Property	Value
Name	SerialReceiveParityErrorCount <a href="#">[Serial Port Selector]</a>
Interface	Integer
Access	RO
Unit	
Visibility	Expert

## 20 File Access

### 20.1 File Access

The file access interface allows access to the cameras file system.

It provides access to the cameras user set files, LUT files and a user definable file.

Usage of the file access features and registers should not be attempted directly. Instead access the file system through the file access interface of the host application.

The user set files are treated differently than the other files in the system. These file when uploaded will modify the user set setting within the camera. If the user set file is from an older version of the camera or a different model, the user sets with in the file will be converted to the appropriate user sets for the new firmware. The file will then be replaced with the updated user set file. If the file contains user sets that are not appropriate for the firmware version on the camera, they will be ignored and discarded. If the file has been modified in any way, the file will be discarded and regenerated.

While a file is open within the file access interface, the camera will not be able to start acquisition. Also, the FileAccessExecute command will be disabled when the camera is in acquisition mode. Care should be taken to not leave any file open within the camera's file system as it will disable the start acquisition register without any feedback as to why.

### 20.2 Summary Table

Name	Interface	Access	Visibility	Description
<a href="#">File Selector</a>	IEnumeration	RW	Guru	Selects which file is being operated on. This must be set before performing any file operations.
<a href="#">File Operation Selector</a>	IEnumeration	RW	Guru	Sets operation to execute on the selected file when the execute command is given.
<a href="#">File Operation Execute</a>	ICommand	WO	Guru	This is a command that executes the selected file operation on the selected file.
<a href="#">File Open Mode</a>	IEnumeration	RW	Guru	The mode of the file when it is opened. The file can be opened for reading, writing or both. This must be set before opening the file.
<a href="#">File Access Buffer</a>	IRegister	RW	Guru	Defines the intermediate access buffer that allows the exchange of data between the device file storage and the application.
<a href="#">File Access Offset</a>	IInteger	RW	Guru	Controls the Offset of the mapping between the device file storage and the FileAccessBuffer.

Name	Interface	Access	Visibility	Description
<a href="#">File Access Length</a>	IInteger	RW	Guru	Controls the Length of the mapping between the device file storage and the FileAccessBuffer.
<a href="#">File Operation Status</a>	IEnumeration	RO	Guru	Represents the file operation execution status.
<a href="#">File Operation Result</a>	IInteger	RO	Guru	Represents the file operation result. For Read or Write operations, the number of successfully read/written bytes is returned.
<a href="#">File Size</a>	IInteger	RO	Guru	Represents the size of the selected file in bytes.

## 20.3 File Access Features

### 20.3.1 File Selector

Selects which file is being operated on. This must be set before performing any file operations.

Property	Value
<b>Name</b>	FileSelector
<b>Interface</b>	IEnumeration
<b>Access</b>	RW
<b>Visibility</b>	Guru

#### Enumeration Values

UserSetDefault
UserSet0
UserSet1
UserFile1
SerialPort0

### 20.3.2 File Operation Selector

Sets operation to execute on the selected file when the execute command is given.

Property	Value
<b>Name</b>	FileOperationSelector
<b>Interface</b>	IEnumeration
<b>Access</b>	RW
<b>Visibility</b>	Guru

#### Enumeration Values

Open
Close
Read
Write
Delete

### 20.3.3 File Operation Execute

This is a command that executes the selected file operation on the selected file.

Property	Value
<b>Name</b>	FileOperationExecute
<b>Interface</b>	ICommand
<b>Access</b>	WO
<b>Visibility</b>	Guru

### 20.3.4 File Open Mode

The mode of the file when it is opened. The file can be opened for reading, writing or both. This must be set before opening the file.

Property	Value
<b>Name</b>	FileOpenMode
<b>Interface</b>	IEnumeration
<b>Access</b>	RW
<b>Visibility</b>	Guru

### Enumeration Values

Read
Write
ReadWrite

## 20.3.5 File Access Buffer

Defines the intermediate access buffer that allows the exchange of data between the device file storage and the application.

Property	Value
Name	FileAccessBuffer
Interface	IRegister
Access	RW
Visibility	Guru

## 20.3.6 File Access Offset

Controls the Offset of the mapping between the device file storage and the FileAccessBuffer.

Property	Value
Name	FileAccessOffset
Interface	Integer
Access	RW
Unit	B
Visibility	Guru

## 20.3.7 File Access Length

Controls the Length of the mapping between the device file storage and the FileAccessBuffer.

Property	Value
Name	FileAccessLength
Interface	Integer
Access	RW

Property	Value
Unit	B
Visibility	Guru

### 20.3.8 File Operation Status

Represents the file operation execution status.

Property	Value
Name	FileOperationStatus
Interface	IEnumeration
Access	RO
Visibility	Guru

#### Enumeration Values

Success
Failure
Overflow

### 20.3.9 File Operation Result

Represents the file operation result. For Read or Write operations, the number of successfully read/written bytes is returned.

Property	Value
Name	FileOperationResult
Interface	IInteger
Access	RO
Unit	
Visibility	Guru

### 20.3.10 File Size

Represents the size of the selected file in bytes.

Property	Value
Name	FileSize
Interface	Integer
Access	RO
Unit	B
Visibility	Guru

## 21 Transfer Control

The Transfer Control category contains features that control the transferring of image data to the host.

An acquisition generates frames that are optionally processed and may have extra data appended (chunk data) before being placed in the transfer queue for transmission out of the device. Once the image data has gone through any processing and had the appropriate data appended it is referred to as a block. These blocks are then handed to the transfer module to be sent out of the device on data streams. The transfer module then transmits these blocks externally on stream channels.

This can be manually or automatically controlled. Use the [Transfer Control Mode](#) to select the control method. There are three options: Basic, Automatic, and User Controlled.

In both Basic and Automatic mode the camera starts transmitting data as soon as there is enough data to fill a link layer packet. This reduces the latency between when the image was acquired and when it is available to the user. As long as the link layer is able to transfer data blocks faster than they are being generated the camera continuously sends one image after another on the stream channel.

There is a Transfer Queue which starts to fill up if the link slows down.

The [Transfer Queue Max Block Count](#) indicates the transfer queue's maximum capacity.

The [Transfer Queue Current Block Count](#) indicates the number of blocks currently in the transfer queue.

The [Transfer Queue Overflow Count](#) indicates the number of blocks that have been lost before being transmitted.

The [Transfer Queue Mode](#) indicates the mechanism for transmitting and overwriting blocks in the transfer queue. It is First In First Out, which means the oldest block in the queue is always sent next on the stream channel.

Once the transfer queue is full the camera overwrites the oldest block in the queue with the new block arriving from the acquisition and processing modules that has not already begun being transmitted. At this point the Queue Overflow is incremented. Once the image that is currently being transmitted finishes, the transmission module transmits the next oldest image in the transfer queue.

In User Controlled mode you can directly control the transfer of blocks. Use the Transfer Operation Mode to select an operation mode. There are two options: Continuous and Multi Block.

Continuous sends images without stopping in the same manner as Basic/Automatic, but you can use [Transfer Start](#) and [Transfer Stop](#) to control the streaming while acquisition runs independently.

Multi Block transmits a specified number of blocks and then stops. Use the [Transfer Block Count](#) to specify the number of blocks. Use the [Transfer Start](#) command to initiate a multi block transfer.

**Note:** Acquisition can be started and stopped without affecting the transfer queue or transfer state however closing the stream channel clears both the queue and any pending transmissions.



## 21.1 Summary Table

Name	Interface	Access	Visibility	Description
<a href="#">Transfer Control Mode</a>	IEnumeration	RW	Expert	Selects the control method for the transfers. Basic and Automatic start transmitting data as soon as there is enough data to fill a link layer packet. User Controlled allows you to directly control the transfer of blocks.
<a href="#">Transfer Operation Mode</a>	IEnumeration	RW	Expert	Selects the operation mode of the transfer. Continuous is similar to Basic/Automatic but you can start/stop the transfer while acquisition runs independently. Multi Block transmits a specified number of blocks and then stops.
<a href="#">Transfer Block Count</a>	Integer	RW	Expert	Specifies the number of data blocks (images) that the device should stream before stopping. This feature is only active if the Transfer Operation Mode is set to Multi Block.
<a href="#">Transfer Queue Max Block Count</a>	Integer	RO	Expert	Returns the maximum number of data blocks (images) in the transfer queue
<a href="#">Transfer Queue Current Block Count</a>	Integer	RO	Expert	Returns number of data blocks (images) currently in the transfer queue.
<a href="#">Transfer Queue Overflow Count</a>	Integer	RO	Expert	Returns number of images that have been lost before being transmitted because the transmit queue hasn't been cleared fast enough.
<a href="#">Transfer Queue Mode</a>	IEnumeration	RW	Expert	Specifies the operation mode of the transfer queue.
<a href="#">Transfer Start</a>	ICommand	WO	Expert	Starts the streaming of data blocks (images) out of the device. This feature is available when the Transfer Control Mode is set to User Controlled.
<a href="#">Transfer Stop</a>	ICommand	WO	Expert	Stops the streaming of data block (images). The current block transmission is completed. This feature is available when the Transfer Control Mode is set to User Controlled.

## 21.2 Transfer Control Features

### 21.2.1 Transfer Control Mode

Selects the control method for the transfers. Basic and Automatic start transmitting data as soon as there is enough data to fill a link layer packet. User Controlled allows you to directly control the transfer of blocks.

Property	Value
<b>Name</b>	TransferControlMode
<b>Interface</b>	IEnumeration
<b>Access</b>	RW
<b>Visibility</b>	Expert

#### Enumeration Values

Basic
Automatic
UserControlled

### 21.2.2 Transfer Operation Mode

Selects the operation mode of the transfer. Continuous is similar to Basic/Automatic but you can start/stop the transfer while acquisition runs independently. Multi Block transmits a specified number of blocks and then stops.

Property	Value
<b>Name</b>	TransferOperationMode
<b>Interface</b>	IEnumeration
<b>Access</b>	RW
<b>Visibility</b>	Expert

#### Enumeration Values

Continuous
MultiBlock

### 21.2.3 Transfer Block Count

Specifies the number of data blocks (images) that the device should stream before stopping. This feature is only active if the Transfer Operation Mode is set to Multi Block.

Property	Value
<b>Name</b>	TransferBlockCount
<b>Interface</b>	Integer
<b>Access</b>	RW
<b>Unit</b>	
<b>Visibility</b>	Expert

### 21.2.4 Transfer Queue Max Block Count

Returns the maximum number of data blocks (images) in the transfer queue

Property	Value
<b>Name</b>	TransferQueueMaxBlockCount
<b>Interface</b>	Integer
<b>Access</b>	RO
<b>Unit</b>	
<b>Visibility</b>	Expert

### 21.2.5 Transfer Queue Current Block Count

Returns number of data blocks (images) currently in the transfer queue.

Property	Value
<b>Name</b>	TransferQueueCurrentBlockCount
<b>Interface</b>	Integer
<b>Access</b>	RO
<b>Unit</b>	
<b>Visibility</b>	Expert

## 21.2.6 Transfer Queue Overflow Count

Returns number of images that have been lost before being transmitted because the transmit queue hasn't been cleared fast enough.

Property	Value
<b>Name</b>	TransferQueueOverflowCount
<b>Interface</b>	IInteger
<b>Access</b>	RO
<b>Unit</b>	
<b>Visibility</b>	Expert

## 21.2.7 Transfer Queue Mode

Specifies the operation mode of the transfer queue.

Property	Value
<b>Name</b>	TransferQueueMode
<b>Interface</b>	IEnumeration
<b>Access</b>	RW
<b>Visibility</b>	Expert

### Enumeration Values

FirstInFirstOut

## 21.2.8 Transfer Start

Starts the streaming of data blocks (images) out of the device. This feature is available when the Transfer Control Mode is set to User Controlled.

Property	Value
<b>Name</b>	TransferStart
<b>Interface</b>	ICommand
<b>Access</b>	WO
<b>Visibility</b>	Expert

## 21.2.9 Transfer Stop

**Stops the streaming of data block (images). The current block transmission is completed. This feature is available when the Transfer Control Mode is set to User Controlled.**

Property	Value
<b>Name</b>	TransferStop
<b>Interface</b>	ICommand
<b>Access</b>	WO
<b>Visibility</b>	Expert

# Contacting Us

For any questions, concerns or comments please contact us:

Email	<a href="#">General questions</a> <a href="#">Technical support</a> (existing customers only)
Knowledge Base	Find answers to commonly asked questions in our <a href="#">Knowledge Base</a>
Downloads	<a href="#">Download</a> the latest documents and software
Contact Information	<a href="#">Contact Us</a> on our website