

This highspeed lens is optimized for 16k with 3.5 μm (57.3 mm) and 12k / 5 μm (62.5 mm) line scan sensors but also can be used in many applications with area sensors up to 67mm diagonal. Optimized for a specific magnification of 0.07x the lens provides high performance in a compact and robust package. The V70-Mount interface makes it easy to install numerous mounts and allows the rotation of the lens into the best azimuth.

Key features

- Designed for 16k / 3.5 μm and 12k / 5 μm line scan sensors
- Best azimuth marking
- 400 nm to 1000 nm broadband AR-coating
- Lockable distance and aperture settings

Applications

- FPD inspection
- PCB inspection
- High resolution defect detection
- AOI (Automated Optical Inspection)

Technical specifications

Type [standard]	V70
ID [standard]	1068013
Interface	V70-Mount
Focal length [mm]	95
F/# range	F/4.5 ... F/8
Numerical aperture [object image]	0.007 0.10
Max. sensor size [mm]	62.5
Max. angle of view [°]	34
Rec. magnification range	-0.07 (-0.17 ... -0.03)
Rec. working distance range [mm]	601 ... 3209
Max. mechanical focus travel [mm]	23.9
Filter thread [mm]	M52 x 0.75
Storage temperature [°C]	-25 ... +70
Net. weight [standard] [g]	735
Additional info	-
f'eff [mm]	95.00
SF [mm]	-50.28
S'F' [mm]	53.16
HH' [mm]	-1.92
β 'P	1.00
SEP [mm]	44.59
S'AP [mm]	-41.96
Σd [mm]	84.63

MTF charts

Spectrum name	VIS					
Wavelengths [nm]	425	475	525	575	625	675
Rel. weights [%]	8	16	23	22	19	13

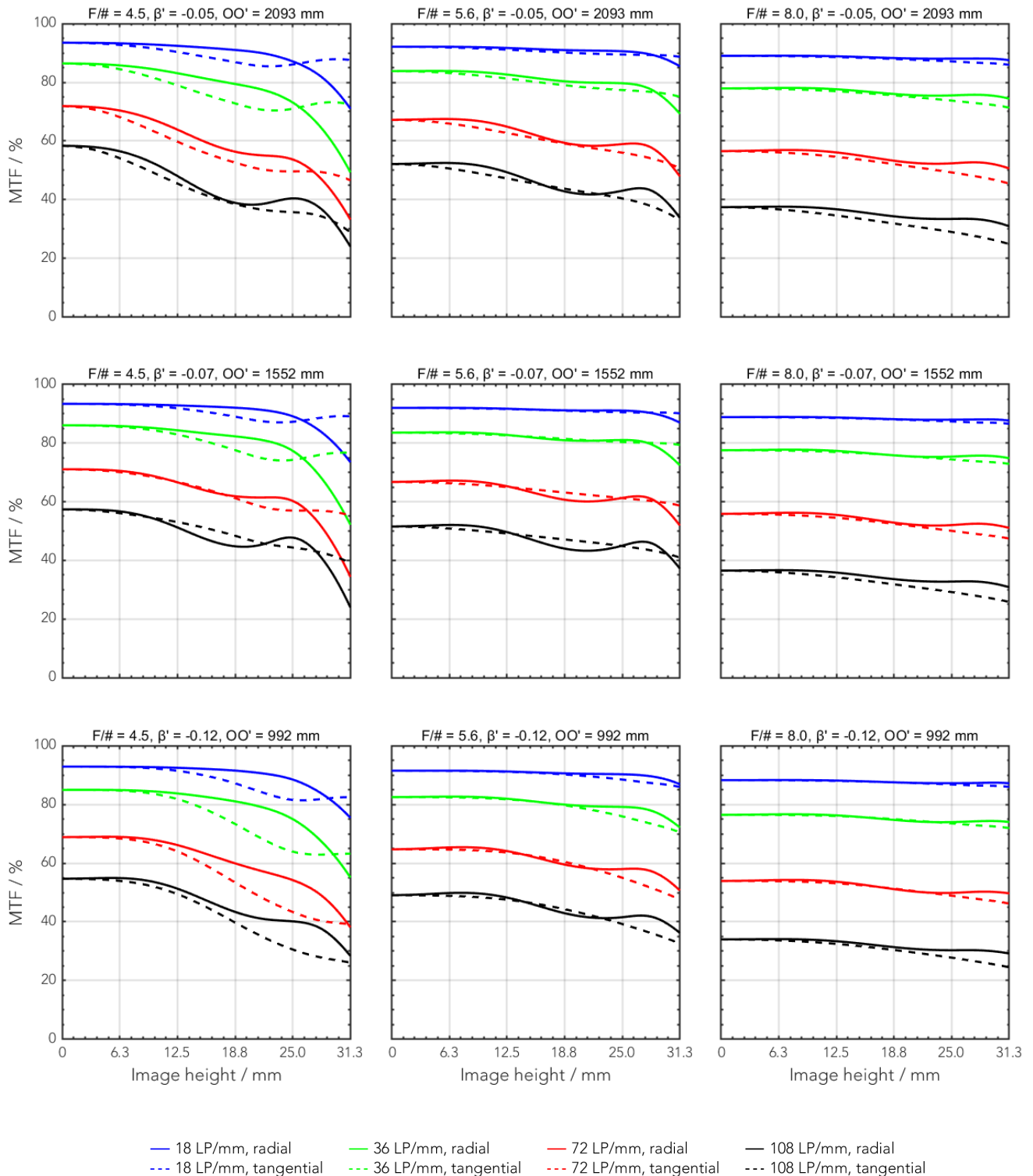

Rel. illumination vs. image height

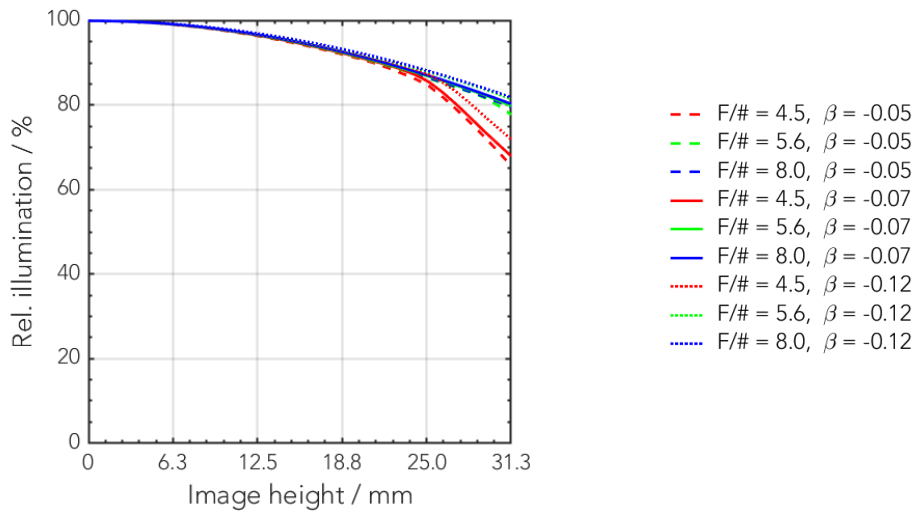

Distortion vs. image height

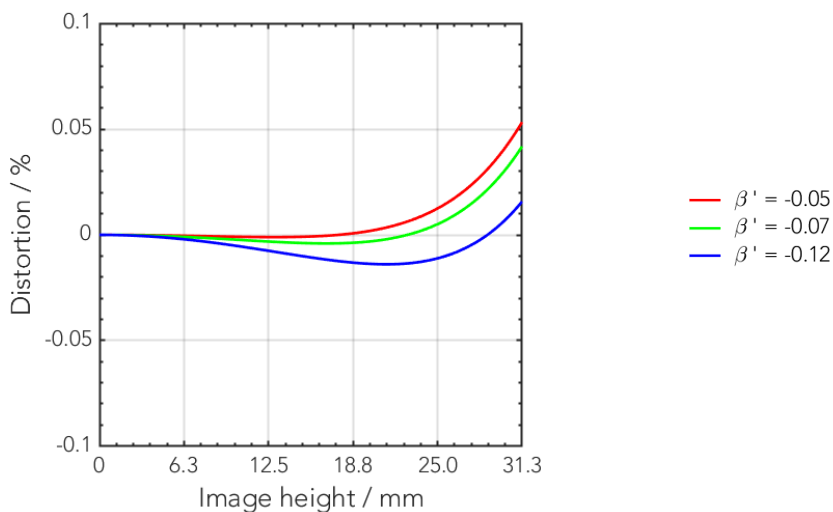

Transmittance vs. wavelength

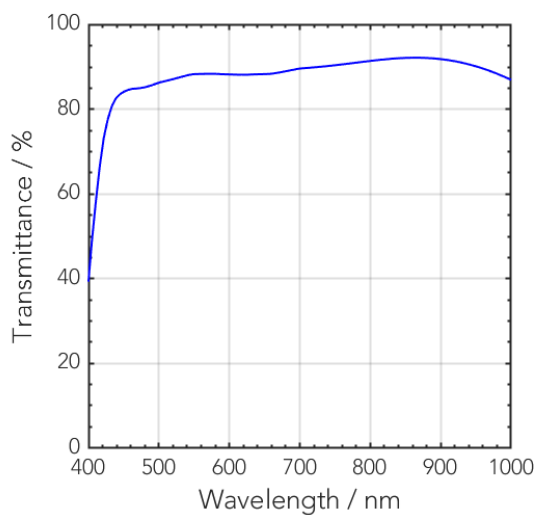

Technical drawings

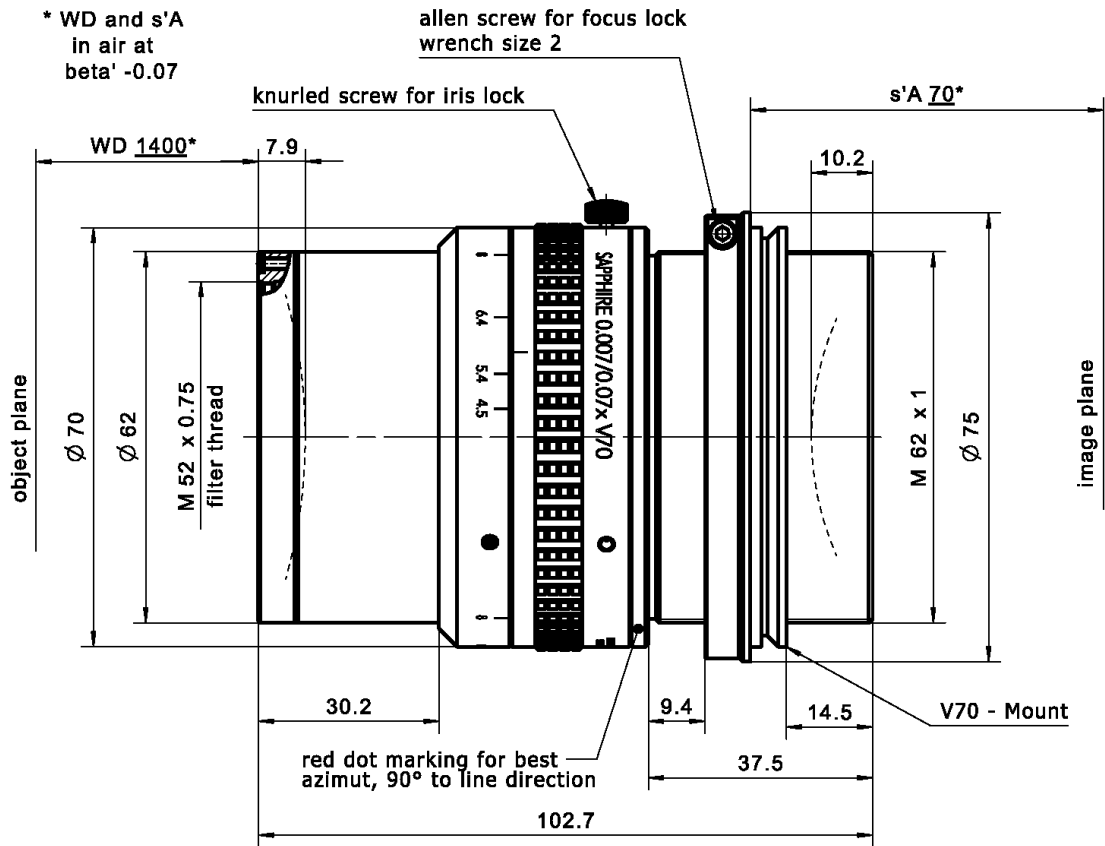

Accessories	Mount	Eff. length	ID
Adapter	V70 / M72 x 0.75	10 mm	1072419
	M72 x 0.75 / M42 x 1	6 mm	1079515
	M72 x 0.75 / M58 x 0.75	4 mm	1075556
	M72 x 0.75 / M90 x 1	4 mm	1084879
	M72 x 0.75 / M95 x 1	4 mm	1077013
Extension tube	M72 x 0.75 / M72 x 0.75	5 mm	1072420
	M72 x 0.75 / M72 x 0.75	10 mm	1072421
	M72 x 0.75 / M72 x 0.75	25 mm	26406
	M72 x 0.75 / M72 x 0.75	50 mm	1054733
	M72 x 0.75 / M72 x 0.75	100 mm	1079483
	M90 x 1 / M90 x 1	10 mm	1084875
	M90 x 1 / M90 x 1	25 mm	1084876
	M90 x 1 / M90 x 1	50 mm	1084877
	M90 x 1 / M90 x 1	100 mm	1084878
	M95 x 1 / M95 x 1	10 mm	1077290
	M95 x 1 / M95 x 1	25 mm	1062892
	M95 x 1 / M95 x 1	50 mm	1062893
	M95 x 1 / M95 x 1	100 mm	1062894
	M95 x 1 / M95 x 1	200 mm	1077291

Annotation	
Focal length	Nominal focal length
F/# range	Image space F-number range for infinity focus position
Numerical aperture	Maximum real numerical aperture (depending on recommended magnification range either for infinity or respective fixed magnification)
Max. sensor size	Image circle diameter
Max. angle of view	Angle of view associated with maximum sensor size (depending on recommended magnification range either for infinity or respective fixed magnification)
Rec. magnification range	Magnification range as recommended by Schneider-Kreuznach
Rec. working distance range	Working distance, i.e. distance between object and first mechanical element, associated with recommended magnification range
Max. mechanical focus travel	Maximum possible movement of the lens from infinity position (depending on recommended magnification range either for infinity or respective fixed magnification)
Net weight	weight of unpacked lens without lens cap
f'_{eff}	Effective focal length
SF	Distance between vertex of first lens surface and object space focal point
S'F'	Distance between vertex of last lens surface and image space focal point (back focal distance at infinity)
HH'	Distance between principal planes
$\beta'P$	Pupil magnification (= exit pupil diameter / entrance pupil diameter)
SEP	Distance between vertex of first lens surface and entrance pupil
S'AP	Distance between vertex of last lens surface and exit pupil
Σd	Distance between vertices of first and last lens surface
s'A	Flange focal distance (in air) for infinite object distance (depending on recommended magnification range either for infinity or respective fixed magnification)
β'	Magnification (= image size / object size), negative value because image is inverted
OO'	Distance between object and image

Unless otherwise stated all dimensions in this data sheet are in mm.

Headquarters Europe

Jos. Schneider Optische Werke GmbH

Ringstraße 132

55543 Bad Kreuznach

☎ +49 671 601 205

✉ cs@schneiderkreuznach.com

www.schneiderkreuznach.com

Offices Worldwide

America

☎ +1 800 645 7239 (East Coast)

☎ +1 800 228 1254 (West Coast)

✉ info@schneideroptics.com

Asia

☎ +86 755 8832 1170

✉ info@schneider-asiapacific.com